



Catalogue 2025

Security and access control
for all buildings



**Pioneering safety.**

CISA, Costruzioni Italiane Serrature e Affini, was established in Florence in 1926 by Luigi Bucci. The brand soon became a household name, thanks to its patent of the very first electric controlled lock which revolutionised the principle of opening and closing doors and gates. Today CISA is one of the top brands in locking and access control systems and, since December 2013, one of the founders of the international group Allegion, together with leading brands in the security technology sector.

Research and innovation.

CISA offers a constantly evolving range of solutions, thanks to daily commitment to 100% Italian research and development. A significant number of international patents are registered every year to meet the highest regulatory standards.

Specific solutions for all needs.

From private residences to business centres, schools, hospitals and hotels, security is the number one priority for CISA and all its access control and management solutions are designed with this in mind. CISA leads the field in providing answers to all its customers' needs, whatever the environment, with dedicated solutions to prevent unlawful access to any kind of door or entrance. CISA also produces systems which provide safe egress to everyone, even those with reduced mobility, in the event of danger or difficulty.

Someone you can depend on.

CISA operates nationwide and is always on hand to assist security professionals: from security managers to architects, managers of technical departments and apartment building administrators, down to those who take the security of their homes seriously. It provides all round support thanks to its authorised "CISA Solution Partner" centres which provide experience, advice and services with the technology and solidity that has made CISA a household name.

More comfort and design.

CISA designs and manufactures master key systems (where one key opens several doors) for any premises, from individual homes to hospitals, to allow more convenient and economical management of multiple accesses, while still guaranteeing the highest security standards. This system is complemented by an effective system to control key duplication (Security Card). Thanks to its electro-mechanical solutions, accesses can be controlled in real time and credentials easily changed. And CISA also has an eye for design, with product ranges that blend into their surroundings and are available in a variety of colours and models.

Visit cisa.com



Catalogue 2025

Analytic index

Special executions

Key blanks

Cylinders

Padlocks

Locks for steel doors

Locks for aluminium doors

Locks for wooden doors

Locks for armour plated doors

Fire door locks and panic exit devices

Locks and panic exit devices

Door closers

Safes

Keying kits

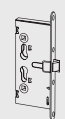
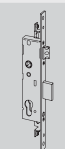

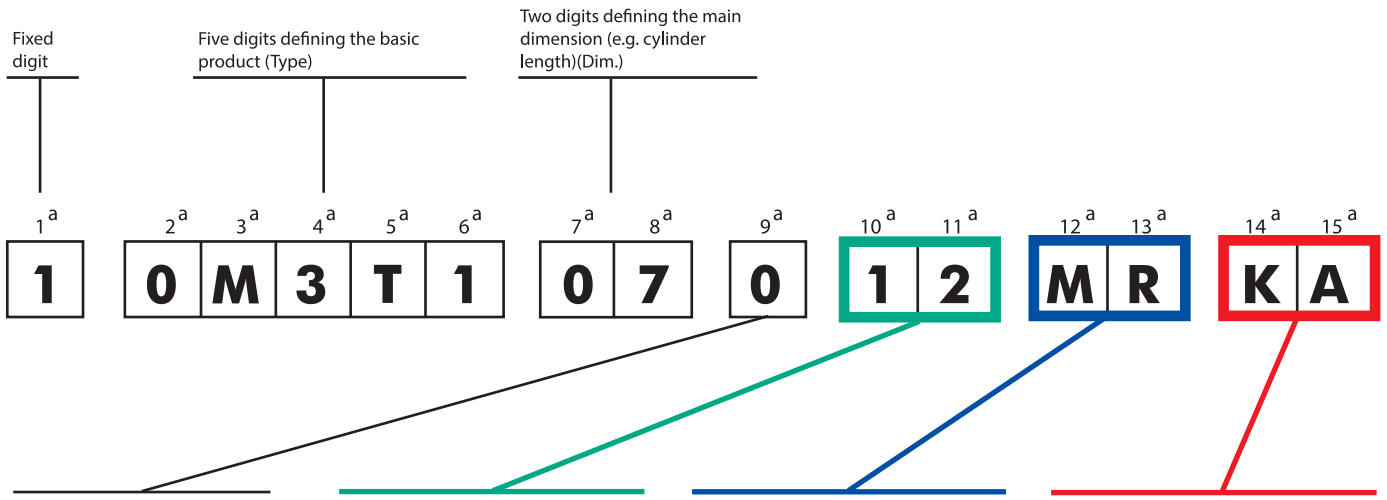

One digit for the hand:

Locks:

- 0 = reversible
- 1 = right hand inwards
- 2 = left hand inwards
- 3 = right hand outwards
- 4 = left hand outwards

Electric strikerst:

- 0 = reversible
- 1 = right hand inwards
- left hand outwards
- 2 = left hand inwards
- right hand outwards

Panic exit devices

- 0 = reversible
- 1 = right hand outwards
- 2 = left hand outwards

Two digits which **must always be the 10th and the 11th**, defining a **FINISH** other than the standard ones. Use the **green codes** from the finishes list.

Two digits which **must always be the 12th and the 13th**, defining **PERSONALIZATION**, if any. Any personalization must be **previously agreed upon with CISA** who will assign the relevant code.

Two digits which **must always be the 14th and the 15th**, defining any **SPECIAL EXECUTION**. Use the **red codes** from the special features list. Orders for un-coded special features must be accompanied by a description.

EXAMPLES:

1) When ordering a **basic item** from the list specify the code up to the hand digit. For example, to order a cylinder:

1 | 0M311 | 070 | | |

3) When ordering a personalized item, for example a **cylinder with a customer's design feature**, indicate:

1 | 0M311 | 070 | 00 | MR |

where MR is to be assigned by CISA

2) When ordering an item with a non-standard finish, for example a **nickel-plated cylinder**, indicate:

1 | 0M311 | 070 | 12 | |

4) When ordering a special item, for example a **KA cylinder**, indicate:

1 | 0M311 | 070 | 00 | MR | KA

EN STANDARDS OVERVIEW

For determination of the Classification Coding System



European standard EN 1303:2015
CYLINDERS

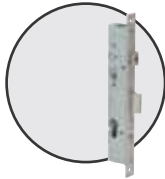

European standard EN 12209:2016
MECHANICAL LOCKS



European standard prEN 15865:2019
MULTIPOINT MECHANICAL LOCKS



European standard EN 14846:2008
ELECTRICAL LOCKS

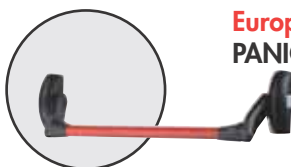

European standard EN 1125:2008
PANIC EXIT DEVICES



European standard EN 179:2008
PUSH PAD PANIC EXIT DEVICES

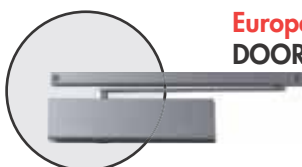

European standard EN 1154:1996 + A1:2002/A2:200
DOOR CLOSERS



CYLINDERS

Example for AP4 S cylinders

1	2	3	4	5	6	7	8
1	6	0	B	0	C	6	D

1 Category of use

Grade 1: for use by people with a high incentive to exercise care

2 Durability

Grade 4: 25 000 cycles
 Grade 5: 50 000 cycles
 Grade 6: 100 000 cycles

3 Door mass

Grade 0: all

4 Suitability for use on fire/smoke doors

Grade 0: Not approved for use on fire/smoke door
 Grade A: Suitable for use on smoke door assemblies
 Grade B: Suitable for use on fire/smoke door assemblies

5 Safety

Grade 0: all

6 Corrosion resistance and temperature

Grade 0: No defined corrosion resistance, no temperature requirement
 Grade A: High corrosion resistance, no temperature requirement
 Grade B: No defined corrosion requirement, temperature requirement: -25°C to +65°C
 Grade C: High corrosion resistance; temperature requirement: -25°C to +65°C

7 Key related security

Grade 1: 100 effective differs, minimum 2 mobile elements
 Grade 2: 300 effective differs, minimum 3 mobile elements
 Grade 3: 15,000 effective differs, minimum 5 mobile elements
 Grade 4: 30,000 effective differs, minimum 5 mobile elements
 Grade 5: 30,000 effective differs, minimum 6 mobile elements
 Grade 6: 100,000 effective differs, minimum 6 mobile elements

8 Attack resistance

Grade 0: No defined resistance to drilling and mechanical attack
 Grade A: Resistance to drilling for 3/5 mins and mechanical attack, excluding plug extraction
 Grade B: Resistance to drilling for 5/10 mins and mechanical attack, excluding plug extraction
 Grade C: Resistance to drilling for 3/5 mins and mechanical attack
 Grade D: Resistance to drilling for 5/10 mins and mechanical attack



MECHANICAL LOCKS

Example for a Multitop PRO lock,
series 49225

1 2 3 4 5 6 7 8
| 3 | X | 9 | 0 | 0 | G | 6-7 | 0 |

1 Category of use

- Grade 1: For use by people with a high incentive to exercise care and with a small chance of misuse, e.g. residential doors
- Grade 2: For use by people with some incentive to exercise care but where there is some chance of misuse, e.g. office doors
- Grade 3: For use by the public where there is little incentive to exercise care and where there is a high chance of misuse, e.g. doors in public buildings

2 Durability

- Grade A: 50 000 test cycles no force on latch bolt, or for locks without latchbolt
- Grade B: 100 000 test cycles no force on latch bolt, or for locks without latchbolt
- Grade C: 200 000 test cycles no force on latch bolt, or for locks without latchbolt
- Grade L: 100 000 test cycles 25 N load on latchbolt
- Grade M: 200 000 test cycles 25 N load on latchbolt
- Grade R: 100 000 test cycles 50 N load on latchbolt
- Grade S: 200 000 test cycles 50 N load on latchbolt
- Grade W: 100 000 test cycles 120 N load on latchbolt
- Grade X: 200 000 test cycles 120 N load on latchbolt

3 Door mass and closing force

- Grade 0: Locks without a latchbolt
- Grade 1: Up to 100 kg door mass 50 N maximum closing force
- Grade 2: Up to 200 kg door mass 50 N maximum closing force
- Grade 3: Above 200 kg door mass or as specified by the manufacturer 50 N maximum closing force
- Grade 4: Up to 100 kg door mass 25 N maximum closing force
- Grade 5: Up to 200 kg door mass 25 N maximum closing force
- Grade 6: Above 200 kg door mass or as specified by the manufacturer 25 N maximum closing force
- Grade 7: Up to 100 kg door mass 15 N maximum closing force
- Grade 8: Up to 200 kg door mass 15 N maximum closing force
- Grade 9: Above 200 kg door mass or as specified by the manufacturer 15 N maximum closing force

4 Suitability for use on fire resisting and/or smoke control doorset

- Grade 0: Not verified for use on fire resisting /smoke control doorset assemblies;
- Grade A: For use on smoke control doorset assemblies based on a test in accordance with EN 1634-3 where the lock contributes to the integrity
- Grade B: For use on smoke control and fire resisting doorset assemblies based on a test in accordance with EN 1634-1 or EN 1634-2 where the lock contributes to the integrity;
- Grade N: For use on smoke control and fire resisting doorset assemblies based on tests where the lock does not contribute to keeping the door in a closed position during the fire resisting and/or smoke control test;

5 Safety

- Grade 0: No safety requirement

6 Corrosion Resistance and Temperature

- Grade 0: No defined corrosion resistance, no temperature requirement
- Grade A: Low corrosion resistance (24 h), no temperature requirement
- Grade C: High corrosion resistance (96 h), no temperature requirement
- Grade D: Very high corrosion resistance (240 h), no temperature requirement
- Grade F: High corrosion resistance (96 h), Temperature requirement: -10°C to +60°C
- Grade G: Very high corrosion resistance (240 h), Temperature requirement: -10°C to +60°C

7 Security and drill resistance

Grade	Side force on deadbolt	Disengaging force	Deadbolt projection	In case of hook, resistance for pulling of anti-separation bolt	In case of hook, resistance to forcing of anti-lifting device in sliding door lock	Drill resistance
0	-	-	-	-	-	-
1	1 kN	1 kN	10 mm	1 kN	1 kN	no
2	3 kN	2 kN	12 mm	3 kN	3 kN	no
3	5 kN	4 kN	14 mm	5 kN	3 kN	no
4	7 kN	5 kN	20 mm	7 kN	5 kN	no
5	7 kN	5 kN	20 mm	7 kN	5 kN	yes
6	10 kN	6 kN	20 mm	10 kN	6 kN	no
7	10 kN	6 kN	20 mm	10 kN	6 kN	yes

note: 1 kN = 100 kg

8 Key identification of lever locks

- Grade 0: No requirement
- Grade A: Minimum three detaining elements
- Grade B: Minimum five detaining elements
- Grade C: Minimum five detaining elements, extended number of effective differs
- Grade D: Minimum six detaining elements
- Grade E: Minimum six detaining elements, extended number of effective differs
- Grade F: Minimum seven detaining elements
- Grade G: Minimum seven detaining elements, extended number of effective differs
- Grade H: Minimum eight detaining elements, extended number of effective differs

MULTIPOINT MECHANICAL LOCKS

Example for a Multipoint PRO lock, series 9400/49500/49600/49700

1 2 3 4 5 6 7 8 9 10
| 3 | X | 9 | A | 0 | G | 6-7 | 0 | 1 | 3 |

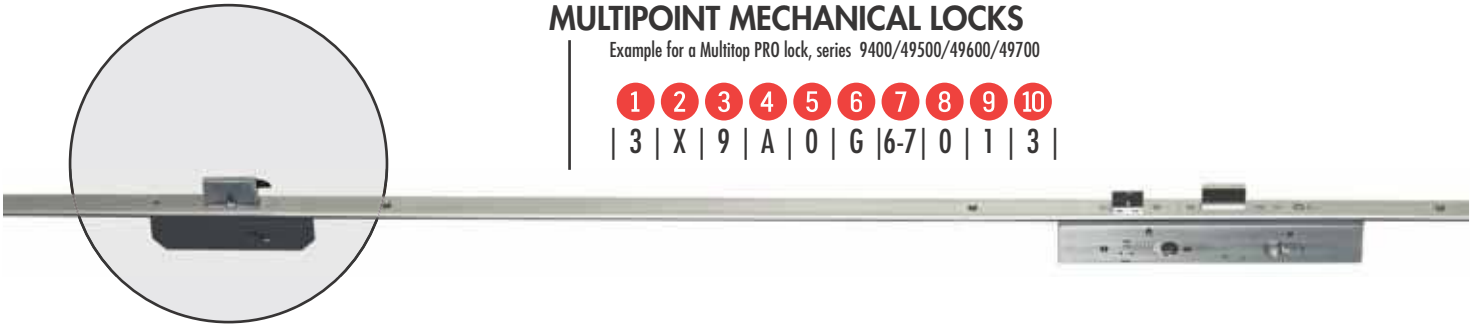

1 Category of use

- Grade 1: for use by people with a high incentive to exercise care and with a small chance of misuse, e.g. residential doors
- Grade 2: for use by people with some incentive to exercise care but where there is some chance of misuse, e.g. office doors.
- Grade 3: for use by the public where there is little incentive to exercise care and where there is a high chance of misuse, e.g. doors in public buildings.

2 Durability

- Grade A: 50 000 test cycles; no load on latch bolt; or for multipoint locks without latchbolt;
- Grade B: 100 000 test cycles; no load on latch bolt; or for multipoint locks without latchbolt;
- Grade C: 200 000 test cycles; no load on latch bolt; or for multipoint locks without latchbolt;
- Grade L: 100 000 test cycles; 25 N load on latch bolt;
- Grade M: 200 000 test cycles; 25 N load on latch bolt;
- Grade R: 100 000 test cycles; 50 N load on latch bolt;
- Grade S: 200 000 test cycles; 50 N load on latch bolt;
- Grade W: 100 000 test cycles; 120 N load on latch bolt;
- Grade X: 200 000 test cycles; 120 N load on latch bolt.

3 Door mass and closing force

- Grade 0: Multipoint locks without a latch bolt (latching function)
- Grade 1: up to 100 kg door mass 50 N maximum closing force
- Grade 2: up to 200 kg door mass 50 N maximum closing force
- Grade 3: above 200 kg door mass 50 N maximum closing force as specified by the manufacturer
- Grade 4: up to 100 kg door mass 25 N maximum closing force
- Grade 5: up to 200 kg door mass 25 N maximum closing force
- Grade 6: above 200 kg door mass 25 N maximum closing force as specified by the manufacturer
- Grade 7: up to 100 kg door mass; 15 N maximum closing force
- Grade 8: up to 200 kg door mass; 15 N maximum closing force
- Grade 9: above 200 kg door mass 15 N maximum closing force as specified by the manufacturer

4 Suitability for use on fire resistance and smoke control doors

- Grade 0: not verified for use on fire resisting /smoke control door set assemblies;
- Grade A: for use on smoke control door set assemblies based on a test in accordance with EN 1634-3 where the multipoint lock contributes to the integrity;
- Grade B: for use on smoke control and fire resisting door set assemblies based on a test in accordance with EN 1634-1 or EN 1634-2 where the multipoint lock contributes to the integrity;
- Grade N: for use on smoke control and fire resisting door set assemblies based on tests where the multipoint lock does not contribute to keeping the door in a closed position during the fire resisting and/or smoke control test;

5 Safety

- Grade 0: no safety requirement

6 Corrosion resistance and temperature

- Grade 0: No defined corrosion resistance, no temperature requirement
- Grade A: Low corrosion resistance (24 h), no temperature requirement
- Grade C: High corrosion resistance (96 h), no temperature requirement
- Grade D: Very high corrosion resistance (240 h), no temperature requirement
- Grade F: High corrosion resistance (96 h), Temperature requirement: -10°C to +60°C
- Grade G: Very high corrosion resistance (240 h), Temperature requirement: -10°C to +60°C

7 Security for locking points

Grade	Side force on deadbolt	Disengaging force	Deadbolt projection	In case of hook, resistance for pulling of anti-separation bolt	In case of hook, resistance to forcing of anti-lifting device in sliding door lock	Drill resistance
0	-	-	-	-	-	-
1	1 kN	1 kN	10 mm	1 kN	1 kN	no
2	3 kN	2 kN	12 mm	3 kN	3 kN	no
3	5 kN	4 kN	14 mm	5 kN	3 kN	no
4	7 kN	5 kN	20 mm	7 kN	5 kN	no
5	7 kN	5 kN	20 mm	7 kN	5 kN	yes
6	10 kN	6 kN	20 mm	10 kN	6 kN	no
7	10 kN	6 kN	20 mm	10 kN	6 kN	yes

note: 1 kN = 100 kg

8 Key identification of lever locks

- Grade 0: Not applicable;
- Grade A: Minimum three detaining elements;
- Grade B: Minimum five detaining elements;
- Grade C: Minimum five detaining elements, extended number of effective differs;
- Grade D: Minimum six detaining elements;
- Grade E: Minimum six detaining elements, extended number of effective differs;
- Grade F: Minimum seven detaining elements;
- Grade G: Minimum seven detaining elements, extended number of effective differs;
- Grade H: Minimum eight detaining elements, extended number of effective differs

9 Security for anti-separation points

Grade	Side force on deadbolt	Disengaging force	Anti-separation point bolt projection	In case of hook, resistance for pulling of anti-separation bolt	In case of hook, resistance to forcing of anti-lifting device in sliding door lock	Drill resistance
0	-	-	-	-	-	-
1	1 kN	1 kN	5 mm	1 kN	1 kN	no
2	3 kN	2 kN	5 mm	1 kN	1 kN	no
3	3 kN	2 kN	5 mm	3 kN	3 kN	no
4	5 kN	4 kN	5 mm	5 kN	4 kN	no
5	7 kN	5 kN	5 mm	7 kN	5 kN	yes
6	10 kN	6 kN	5 mm	10 kN	6 kN	no
7	10 kN	6 kN	5 mm	10 kN	6 kN	yes

note: 1 kN = 100 kg

10 Clenching points

- Grade 0: No clenching force requirements
- Grade 1: Clenching force = 10 N
- Grade 2: Clenching force = 25 N
- Grade 3: Clenching force = 50 N
- Grade 4: Clenching force = 120 N

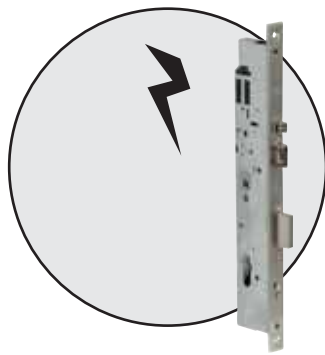

ELECTRICAL LOCKS

Example for a Multitop PRO lock, series 19225

1 2 3 4 5 6 7 8 9
| 3 | X | 9 | 0 | 0 | M | 6-7 | 0 | 2 |

1 Category of use

- Grade 1: For use by people with a high incentive to exercise care and with a small chance of misuse, e.g. residential doors
- Grade 2: For use by people with some incentive to exercise care but where there is some chance of misuse, e.g. office doors.
- Grade 3: For use by the public where there is little incentive to exercise care and where there is a high chance of misuse, e.g. doors in public buildings.

2 Durability

Grade A:	50 000 test cycles	No load on latchbolt
Grade B:	100 000 test cycles	No load on latchbolt
Grade C:	200 000 test cycles	No load on latchbolt
Grade F:	50 000 test cycles	10 N load on latchbolt
Grade G:	100 000 test cycles	10 N load on latchbolt
Grade H:	200 000 test cycles	10 N load on latchbolt
Grade L:	100 000 test cycles	25 N load on latchbolt
Grade M:	200 000 test cycles	25 N load on latchbolt
Grade R:	100 000 test cycles	50 N load on latchbolt
Grade S:	200 000 test cycles	50 N load on latchbolt
Grade W:	100 000 test cycles	120 N load on latchbolt
Grade X:	200 000 test cycles	120 N load on latchbolt
Grade Y:	200 000 test cycles	250 N load on latchbolt

3 Door mass and closing force

Grade 1:	Up to 100 kg door mass	50 N maximum closing force
Grade 2:	Up to 200 kg door mass	50 N maximum closing force
Grade 3:	Above 200 kg door mass or as specified by the manufacturer	50 N maximum closing force
Grade 4:	Up to 100 kg door mass	25 N maximum closing force
Grade 5:	Up to 200 kg door mass	25 N maximum closing force
Grade 6:	Above 200 kg door mass or as specified by the manufacturer	25 N maximum closing force
Grade 7:	Up to 100 kg door mass	15 N maximum closing force
Grade 8:	Up to 200 kg door mass	15 N maximum closing force
Grade 9:	Above 200 kg door mass or as specified by the manufacturer	15 N maximum closing force

4 Suitability for use on fire/smoke doors

- Grade 0: Not intended for use on smoke/fire door assemblies
- Grade A: Suitable for use on smoke door assemblies - based solely on the requirements of the relevant product standard
- Grade B: Suitable for use on smoke/fire door assemblies: with a classification time of: 15 min
- Grade C: Suitable for use on smoke/fire door assemblies: with a minimum classification time of: 30 min
- Grade D: Suitable for use on smoke/fire door assemblies: with a minimum classification time of: 60 min
- Grade E: Suitable for use on smoke/fire door assemblies: with a minimum classification time of: 90 min
- Grade F: Suitable for use on smoke/fire door assemblies: with a classification time of: 120 minor grater

5 Safety

- Grade 0: No safety requirement

6 Environmental suitability

Grade 0:	No defined resistance	No defined resistance	No defined resistance
Grade A:	No defined resistance	No defined resistance	+40 °C with initial relative humidity of 95 %
Grade B:	No defined resistance	No defined resistance	+55 °C with initial relative humidity of 95 %
Grade C:	Low resistance (24 h)	+5 °C to +55 °C	+40 °C with initial relative humidity of 95 %
Grade D:	Moderate resistance (48 h)	+5 °C to +55 °C	+40 °C with initial relative humidity of 95 %
Grade E:	High resistance (96 h)	+5 °C to +55 °C	+40 °C with initial relative humidity of 95 %
Grade F:	Very high resistance (240 h)	+5 °C to +55 °C	+40 °C with initial relative humidity of 95 %
Grade G:	Moderate resistance (48 h)	-10 °C to +55 °C	+40 °C with initial relative humidity of 95 %
Grade H:	High resistance (96 h)	-10 °C to +55 °C	+40 °C with initial relative humidity of 95 %
Grade J:	Very high resistance (240 h)	-10 °C to +55 °C	+40 °C with initial relative humidity of 95 %
Grade K:	Moderate resistance (48 h)	-25 °C to +70 °C	+55 °C with initial relative humidity of 95 %
Grade L:	High resistance (96 h)	-25 °C to +70 °C	+55 °C with initial relative humidity of 95 %
Grade M:	Very high resistance (240 h)	-25 °C to +70 °C	+55 °C with initial relative humidity of 95 %
Grade N:	No defined resistance	-25 °C to +70 °C	+40 °C with initial relative humidity of 95 %
Grade P:	No defined resistance	-25 °C to +70 °C	+55 °C with initial relative humidity of 95 %

7 Security and drill resistance

Grade	Side force on deadbolt	Disengaging force	Deadbolt projection	In case of hook, resistance for pulling of anti-separation bolt	In case of hook, resistance to forcing of anti-lifting device in sliding door lock	Drill resistance
0	-	-	-	-	-	-
1	1 kN	1 kN	10 mm	1 kN	1 kN	no
2	3 kN	2 kN	12 mm	3 kN	3 kN	no
3	5 kN	4 kN	14 mm	5 kN	3 kN	no
4	7 kN	5 kN	20 mm	7 kN	5 kN	no
5	7 kN	5 kN	20 mm	7 kN	5 kN	yes
6	10 kN	6 kN	20 mm	10 kN	6 kN	no
7	10 kN	6 kN	20 mm	10 kN	6 kN	yes

note: 1kN = 100 kg

8 Security - electrical function

- Grade 0: no requirement
- Grade 1: status indication

9 Security - electrical manipulation

Grade	Voltage drop protection	Protection against the effect of cutting cables	Protection against the effects of wire manipulation	Resistance to electromagnetic manipulation	Resistance to electrostatic discharge	Resistance to electrostatic manipulation
0						
1					Level 2 (EN 61000-4-2)	
2	yes	yes		yes	Level 4 (EN 61000-4-2)	Level 4 (EN 61000-4-2)
3	yes	yes	yes	yes	Level 4 (EN 61000-4-2)	Level 4 (EN 61000-4-2)

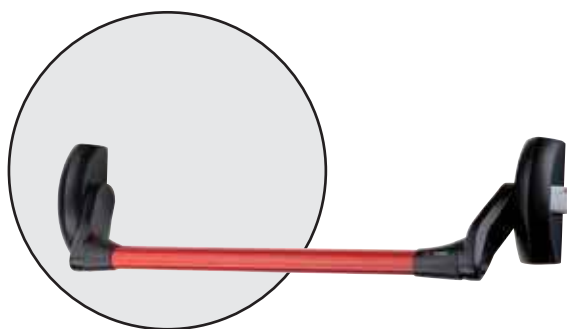

PANIC EXIT DEVICES

Example for Panic exit devices series 59001/11//16

1	2	3	4	5	6	7	8	9	10
3	7	7	A	1	4	2	2	A	A

1 Category of use

Grade 3: High frequency of use where there is little incentive to exercise care, i.e. where there is a chance of an accident occurring and of misuse

2 Durability

Grade 6: 100.000 Test cycles

Grade 7: 200.000 Test cycles

3 Door mass

Grade 5: Up to 100 kg

Grade 6: Up to 200 kg

Grade 7: Above 200 kg

4 Suitability for use on fire/smoke doors

Grade 0: Not approved for use on fire/smoke door assemblies

Grade A: Suitable for use on fire/smoke door assemblies based on the requirements of B.1

Grade B: Suitable for use on fire/smoke door assemblies based on the requirements of EN 1634-1

5 Safety

Grade 1: All panic and emergency devices have a critical safety function therefore only the top grade 1 is identified

6 Corrosion resistance

Two grades of corrosion resistance given in EN 1670:2007, 5.6:

Grade 3: 96 h (high resistance)

Grade 4: 240 h (very high resistance)

7 Security

Grade 2: Panic devices are primarily for the operation of a door from inside and security is secondary to that of safety

8 Projection of horizontal bar

Grade 1: Projection up to 150 mm (large projection)

Grade 2: Projection up to 100 mm (standard projection)

9 Type of horizontal bar operation

Type A: Panic exit device with "push-bar" operation

Type B: Panic exit device with "touch-bar" operation

10 Field of door application

Grade A: Single door, double door: active or inactive leaf

Grade B: Single door only

Grade C: Double door, inactive leaf only



PUSH PAD PANIC EXIT DEVICES

Example for the Push Pad series 59051/61/66

1	2	3	4	5	6	7	8	9	10
3	7	7	A	1	4	5	2	B	A

1 Category of use

Grade 3: High frequency of use where there is little incentive to exercise care, i.e. where there is a chance of an accident occurring and of misuse

2 Durability

Grade 6: 100.000 Test cycles

Grade 7: 200.000 Test cycles

3 Door mass

Grade 5: Up to 100 kg

Grade 6: Up to 200 kg

Grade 7: Above 200 kg

4 Suitability for use on fire/smoke doors

Grade 0: Not approved for use on fire/smoke door assemblies

Grade A: Suitable for use on fire/smoke door assemblies based on the requirements of B.1

Grade B: Suitable for use on fire/smoke door assemblies based on the requirements of EN 1634-1

5 Safety

Grade 1: All panic and emergency devices have a critical safety function therefore only the top grade 1 is identified

6 Corrosion resistance

Two grades of corrosion resistance given in EN 1670:2007, 5.6:

Grade 3: 96 h (high resistance)

Grade 4: 240 h (very high resistance)

7 Security

Grade 2: 1.000 N

Grade 3: 2.000 N

Grade 4: 3.000 N

Grade 5: 5.000 N

8 Projection of operating element

Grade 1: Projection up to 150 mm (large projection)

Grade 2: Projection up to 100 mm (standard projection)

9 Type of operation

Type A: Emergency exit device with "lever handle" operation

Type B: Emergency exit device with "push pad" operation

10 Field of door application

Grade A: Outward opening single exit door, double exit door: active or inactive leaf

Grade B: Outward opening single exit door only

Grade C: Outward opening double exit door: inactive leaf only

Grade D: Inward opening single exit door only

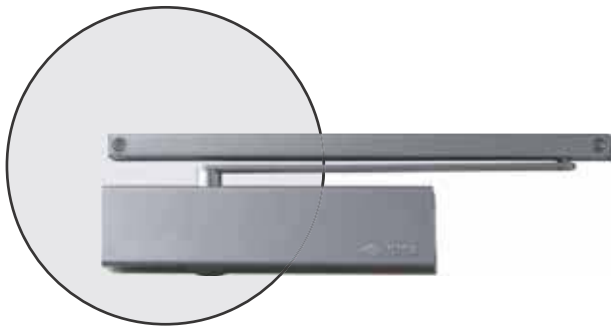

DOOR CLOSERS

Example for door closers
series D5200

1 2 3 4 5 6
| 4 | 8 | 1-4 | 1 | 1 | 3 |

1 Category of use

Grade 3: For closing doors from at least 105° open

Grade 4: For closing doors from 180° open

2 Durability

Only one test duration is identified for door closers manufactured to this standard:

Grade 8: 500.000 Test cycles

3 Door closer power size

Grade 1-7: See table below: Where a door closer provides a range of power sizes both the minimum and the maximum sizes shall be identified

Door closer power size	Recommended door leaf width	Test door mass	Closing moment				Opening moment	Door close efficiency
			between 0° and 4°		between 88° and 92°	any other angle		
			Nm (min)	Nm (max)	Nm (min)	Nm (max)		
1	750	20	9	13	3	2	26	50
2	850	40	13	18	4	3	36	50
3	950	60	18	26	6	4	47	55
4	1.100	80	26	37	9	6	62	60
5	1.250	100	37	54	12	8	83	65
6	1.400	120	54	87	18	11	134	65
7	1.600	160	87	140	29	18	215	65

4 Suitability for use on fire/smoke doors

Grade 0: Not suitable for use on fire/smoke door assemblies

Grade 1: Suitable for use on fire/smoke door assemblies

5 Safety

Grade 1: All door closers are required to satisfy the essential requirement of safety in use; Therefore only grade 1 is identified

6 Corrosion resistance

Grade 0: No defined corrosion resistance

Grade 1: Mild resistance

Grade 2: Moderate resistance

Grade 3: High resistance

Grade 4: Very high resistance



BS OHSAS
18001:2007

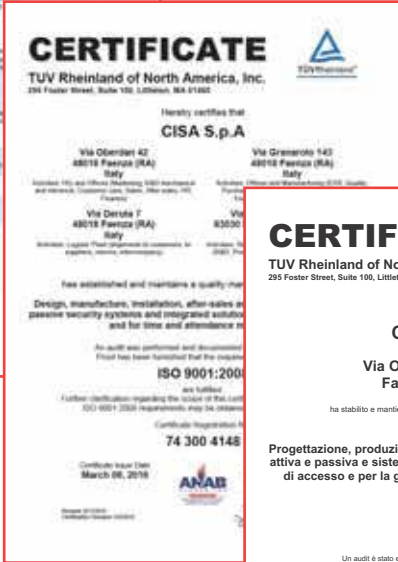

ISO 9001:2008

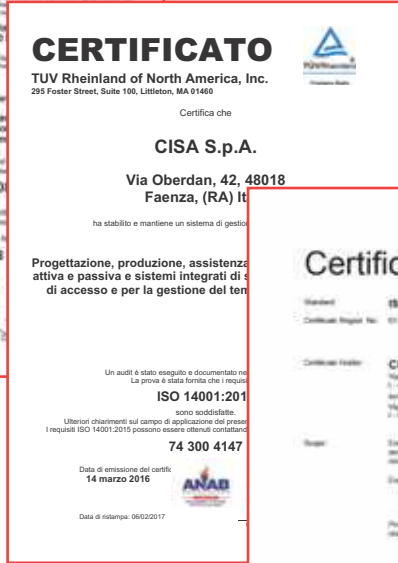

ISO 14001:2004



ISO 50001:2011



AEO F14 0871

Associations



Bodies





CISA™

Analytic index

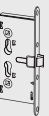
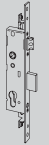

ITEM	PAGE	DRAWING	ITEM	PAGE	DRAWING	ITEM	PAGE	DRAWING	ITEM	PAGE	DRAWING
		Page Table			Page Table			Page Table			Page Table
1 06141 82 0	278		1 06226 00 0	368		1 06283 02 0 B7	372		1 06353 00 0 62	123	
1 06141 84 0	279		1 06231 00 0	371		1 06284 00 0	372		1 06353 00 0 64	123	
1 06141 86 0	279		1 06232 00 0	181		1 06284 01 0	372		1 06354 00 0 23	123	
1 06141 87 0	279		1 06232 01 0	181		1 06285 25 0	296		1 06354 00 0 68	123	
1 06141 88 0	540		1 06232 05 0	280		1 06285 27 0	296		1 06355 00 0 12	123	
1 06141 89 0	279		1 06232 06 0	280		1 06285 30 0	296		1 06355 00 0 66	123	
1 06141 95 0	279		1 06232 20 0	181		1 06285 32 0	296		1 06356 00 0 12	123	
1 06141 96 0	279		1 06232 21 0	181		1 06285 34 0	296		1 06356 00 0 66	123	
1 06142 00 0	371		1 06232 22 0	181		1 06285 35 0	297		1 06357 00 0 12	123	
1 06142 01 0	448		1 06233 00 0	280		1 06285 36 0	297		1 06357 00 0 66	123	
1 06142 85 0	540		1 06233 01 0	281		1 06285 37 0	297		1 06411 01 0	124	
1 06142 95 0	211		1 06233 02 0	281		1 06285 38 0	297		1 06411 02 0	124	
1 06143 00 0	377		1 06233 03 0	281		1 06285 42 0	297		1 06411 03 0	124	
1 06144 10 1	449		1 06235 00 0	371		1 06285 43 0	298		1 06411 04 0	124	
1 06144 15 0	449		1 06236 00 0	375		1 06285 44 0	298		1 06412 01 0	124	
1 06145 10 0	449		1 06237 01 0	375		1 06287 02 0	298		1 06412 02 0	124	
1 06145 11 0	449		1 06243 00 0	368		1 06287 11 0	298		1 06412 03 0	124	
1 06146 00 0	374		1 06271 00 0	371		1 06287 14 0	299		1 06412 04 0	124	
1 06147 00 0	280		1 06272 00 0	371		1 06287 17 0	299		1 06412 51 0	124	
1 06147 01 0	280		1 06275 00 0	371		1 06287 21 0	299		1 06413 01 0	124	
1 06149 00 0	367		1 06277 01 0	289		1 06287 26 0	299		1 06413 02 0	124	
1 06150 00 0	367		1 06277 02 0	289		1 06287 27 0	300		1 06413 03 0	124	
1 06152 00 0	367		1 06277 03 0	289		1 06287 29 0	300		1 06413 04 0	124	
1 06157 00 0	280		1 06277 10 0	290		1 06287 50 0	300		1 06414 01 0	124	
1 06163 00 0	368		1 06277 11 0	290		1 06287 64 0	300		1 06414 02 0	124	
1 06167 00 0	280		1 06277 14 0	290		1 06287 65 0	300		1 06414 03 0	124	
1 06168 00 0	243		1 06277 28 0	290		1 06287 77 0	301		1 06414 04 0	124	
1 06195 05 0	516		1 06277 32 0	290		1 06287 88 0	301		1 06414 20 0	124	
1 06195 06 0	516		1 06277 41 0	290		1 06287 89 0	301		1 06414 25 0	124	
1 06195 07 0	516		1 06277 44 0	291		1 06287 92 0	301		1 06414 30 0	124	
1 06195 08 0	227		1 06277 76 0	291		1 06287 94 0	301		1 06415 00 0	373	
1 06195 09 0	516		1 06277 77 0	291		1 06287 95 0	302		1 06416 00 0	373	
1 06195 10 0	516		1 06277 78 0	291		1 06287 97 0	302		1 06418 00 0	375	
1 06196 43 0	495	545 10	1 06277 80 0	291		1 06290 00 0	281		1 06418 01 0	453	
1 06196 60 0	515		1 06277 88 0	291		1 06290 05 0	181		1 06418 03 0	453	
1 06198 70 0	510		1 06277 89 0	292		1 06290 06 0	181		1 06421 10 1	453	
1 06198 75 0	521		1 06277 92 0	292		1 06290 10 0	181		1 06421 10 2	453	
1 06213 05 0	378		1 06277 98 0	292		1 06291 00 0	372		1 06422 00 0	376	
1 06216 00 0	368		1 06277 99 0	292		1 06291 01 0	281		1 06424 00 0	376	
1 06218 00 0	363		1 06278 00 0	371		1 06291 05 0	373		1 06425 03 0	453	
1 06220 00 0	450		1 06278 02 0	293		1 06291 06 0	281		1 06425 06 0	454	
1 06220 02 0	450		1 06278 04 0	293		1 06291 07 0	182		1 06425 07 0	376	
1 06220 05 0	450		1 06278 05 0	293		1 06291 20 0	373		1 06426 07 0	376	
1 06220 20 0	450		1 06278 06 0	293		1 06292 00 0	378		1 06429 00 0	439	
1 06220 26 0	450		1 06278 07 0	293		1 06292 01 0	379		1 06429 05 0	439	
1 06220 27 0	450		1 06278 11 0	372		1 06293 01 0	379		1 06429 06 0	439	
1 06220 29 0	451		1 06278 16 0	294		1 06300 14 0	146		1 06429 10 0	439	
1 06221 00 0	451		1 06278 17 0	294		1 06300 18 0	146		1 06429 15 0	439	
1 06221 01 0	451		1 06278 20 0	294		1 06301 50 0	146		1 06429 16 0	440	
1 06221 10 0	451		1 06278 21 0	294		1 06301 60 0	146		1 06429 20 0	440	
1 06221 11 0	451		1 06278 22 0	294		1 06316 04 0	510		1 06429 50 0	440	
1 06221 15 0	451		1 06278 26 0	295		1 06322 00 0	379		1 06429 51 0	440	
1 06221 16 0	451		1 06278 27 0	295		1 06323 00 0	379		1 06429 60 1	441	
1 06221 17 0	451		1 06278 28 0	295		1 06323 00 0 82	379		1 06433 00 0	455	
1 06221 18 0	451		1 06278 64 0	295		1 06323 01 0	379		1 06433 01 0	455	
1 06221 20 0	451		1 06278 65 0	295		1 06325 00 0	379		1 06433 10 0	455	
1 06221 50 0	452		1 06278 66 0	295		1 06328 00 0 82	379		1 06433 11 0	455	
1 06221 51 0	452		1 06278 80 0	296		1 06328 00 0 B7	379		1 06434 00 0	455	
1 06221 52 0	452		1 06279 00 0	372		1 06329 00 0	379		1 06434 01 0	455	
1 06221 60 0	452		1 06279 10 0	378		1 06329 00 0 82	379		1 06436 10 0	227	
1 06221 62 0	452		1 06279 11 0	378		1 06329 00 0 B7	379		1 06436 11 0	227	
1 06223 00 0	368		1 06279 12 0	372		1 06331 00 0	380		1 06436 12 0	197	
1 06224 00 0	280		1 06281 00 0	372		1 06353 00 0 44	123		1 06436 13 0	197	
1 06224 50 0	452		1 06282 00 0	372		1 06353 00 0 60	123		1 06437 00 0	455	

ITEM	PAGE	DRAWING		ITEM	PAGE	DRAWING		ITEM	PAGE	DRAWING		ITEM	PAGE	DRAWING	
		Page	Table			Page	Table			Page	Table			Page	Table
1 07552 73 0	598			1 07557 02 0	601			1 07572 81 0	602			1 07580 90 0	66		
1 07552 74 0	598			1 07557 03 0	601			1 07572 82 0	602			1 07580 91 0	66		
1 07552 75 0	598			1 07557 11 0	601			1 07572 83 0	602			1 07582 10 0	76		
1 07552 76 0	599			1 07557 52 0	601			1 07572 84 0	602			1 07582 11 0	76		
1 07552 81 0	599			1 07558 01 0	601			1 07572 85 0	602			1 07582 12 0	76		
1 07552 82 0	599			1 07558 02 0	601			1 07572 87 0	602			1 07582 13 0	76		
1 07552 83 0	599			1 07558 05 0	601			1 07572 88 0	602			1 07582 14 0	76		
1 07552 84 0	599			1 07559 01 0	604			1 07572 89 0	602			1 07582 15 0	76		
1 07552 85 0	599			1 07559 02 0	604			1 07572 90 0	602			1 07582 16 0	76		
1 07552 86 0	599			1 07559 03 0	604			1 07572 91 0	602			1 07582 17 0	76		
1 07553 01 0	599			1 07559 04 0	604			1 07572 92 0	602			1 07582 18 0	76		
1 07553 02 0	599			1 07559 06 0	604			1 07572 96 0	603			1 07582 20 0	76		
1 07553 03 0	599			1 07559 07 0	604			1 07580 01 0	73			1 07582 23 0	76		
1 07553 04 0	599			1 07559 09 0	604			1 07580 02 0	73			1 07582 30 0	75		
1 07553 51 0	599			1 07559 11 0	604			1 07580 03 0	73			1 07582 31 0	75		
1 07554 01 0	599			1 07559 12 0	604			1 07580 05 0	73			1 07582 32 0	75		
1 07554 02 0	599			1 07559 13 0	604			1 07580 10 0	74			1 07582 33 0	75		
1 07554 03 0	599			1 07559 19 0	605			1 07580 11 A	74			1 07582 34 0	75		
1 07554 05 0	599			1 07559 22 0	605			1 07580 11 B	74			1 07582 35 0	75		
1 07554 51 0	599			1 07559 24 0	605			1 07580 12 A	74			1 07582 36 0	75		
1 07554 71 0	600			1 07559 25 0	605			1 07580 12 B	74			1 07582 37 0	75		
1 07554 72 0	600			1 07559 26 0	605			1 07580 13 A	74			1 07582 38 0	75		
1 07554 73 0	600			1 07559 28 0	605			1 07580 13 B	74			1 07582 39 0	75		
1 07554 91 0	600			1 07559 42 0	604			1 07580 14 A	74			1 07582 40 0	75		
1 07554 92 0	600			1 07559 48 0	604			1 07580 14 B	74			1 07582 41 0	75		
1 07555 01 0	600			1 07559 62 0	604			1 07580 15 A	74			1 07582 42 0	75		
1 07555 02 0	600			1 07559 63 0	604			1 07580 15 B	74			1 07582 44 0	75		
1 07555 03 0	600			1 07559 80 0	605			1 07580 16 A	74			1 07582 46 0	75		
1 07555 04 0	600			1 07559 81 0	605			1 07580 16 B	74			1 07582 47 0	75		
1 07555 05 0	600			1 07559 83 0	605			1 07580 17 A	74			1 07582 48 0	75		
1 07555 11 0	600			1 07559 84 0	606			1 07580 20 0	74			1 07582 49 0	75		
1 07555 12 0	600			1 07559 85 0	606			1 07580 29 0	74			1 07582 50 0	75		
1 07555 13 0	600			1 07571 11 0	601			1 07580 30 0	74			1 07582 51 0	75		
1 07555 14 0	600			1 07571 12 0	601			1 07580 31 0	74			1 07582 52 0	75		
1 07555 21 0	600			1 07571 13 0	601			1 07580 32 A	74			1 07582 53 0	75		
1 07555 22 0	600			1 07571 14 0	601			1 07580 33 A	74			1 07582 54 0	75		
1 07555 23 0	600			1 07571 15 0	601			1 07580 34 0	74			1 07582 55 0	75		
1 07555 24 0	600			1 07571 16 0	601			1 07580 47 0 12	74			1 07582 56 0	75		
1 07555 25 0	600			1 07571 17 0	601			1 07580 48 0 12	74			1 07582 57 0	75		
1 07555 26 0	600			1 07571 18 0	601			1 07580 56 0 12	65			1 07582 58 0	75		
1 07555 31 0	600			1 07571 70 0	602			1 07580 57 0 12	65			1 07582 59 0	75		
1 07555 32 0	600			1 07571 71 0	602			1 07580 29 0	65			1 07582 60 0	75		
1 07555 33 0	600			1 07571 72 0	602			1 07580 34 0	65			1 07582 61 0	75		
1 07555 34 0	600			1 07571 73 0	602			1 07580 36 0	66			1 07582 62 0	75		
1 07555 35 0	600			1 07571 74 0	602			1 07580 37 0	66			1 07582 63 0	75		
1 07555 36 0	600			1 07571 75 0	602			1 07580 60 A	74			1 07582 64 0	75		
1 07555 37 0	600			1 07571 76 0	602			1 07580 63 0	66			1 07582 66 0	75		
1 07555 38 0	600			1 07571 77 0	603			1 07580 64 0	66			1 07582 67 0	75		
1 07555 39 0	600			1 07571 78 0	603			1 07580 71 0	65			1 07582 68 0	75		
1 07555 40 0	600			1 07571 79 0	602			1 07580 72 0	65			1 07582 69 0	75		
1 07555 51 0	600			1 07571 80 0	602			1 07580 75 0	66			1 07582 71 0	75		
1 07555 52 0	600			1 07571 93 0	603			1 07580 76 0	66			1 07582 72 0	75		
1 07555 53 0	600			1 07571 94 0	603			1 07580 77 0	66			1 07582 76 0	75		
1 07555 54 0	600			1 07572 01 0	602			1 07580 78 0	66			1 07582 77 0	75		
1 07555 55 0	600			1 07572 02 0	602			1 07580 80 0	66			1 07582 78 0	75		
1 07555 61 0	600			1 07572 03 0	602			1 07580 81 0	66			1 07582 79 0	75		
1 07555 62 0	600			1 07572 71 0	602			1 07580 82 0	66			1 07582 80 0	75		
1 07555 63 0	600			1 07572 72 0	602			1 07580 83 0	66			1 07582 82 0	75		
1 07555 64 0	600			1 07572 73 0	602			1 07580 84 0	66			1 07582 86 0	75		
1 07556 03 0	601			1 07572 74 0	602			1 07580 85 0	66			1 07582 87 0	75		
1 07556 04 0	601			1 07572 75 0	602			1 07580 86 0	66			1 07582 88 0	75		
1 07556 05 0	601			1 07572 76 0	602			1 07580 87 0	66			1 07582 95 0	75		
1 07556 06 0	601			1 07572 77 0	603			1 07580 88 0	66			1 07586 04 0	145		
1 07557 01 0	601			1 07572 78 0	603			1 07580 89 0	66			1 07586 05 0	145		

ITEM	PAGE		DRAWING		ITEM	PAGE		DRAWING		ITEM	PAGE		DRAWING	
			Page	Table				Page	Table				Page	Table
1 57020 60 0	342	388	39		1 57223 60 0	174	191	43		1 57365 90 0	247	312	74	
1 57020 61 0	342	388	39		1 57223 62 0	174	191	43		1 57365 91 0	247	312	74	
1 57020 70 0	342	388	39		1 57225 45 0	347	389	48		1 57370 10 0	247	312	75	
1 57028 50 0	344	388	40		1 57225 50 0	347	389	48		1 57370 90 0	247	312	75	
1 57028 51 0	344	388	40		1 57225 60 0	347	389	48		1 57375 10 0	248	312	76	
1 57028 60 0	344	388	40		1 57226 45 0	174	191	44		1 57375 90 0	248	312	76	
1 57028 61 0	344	388	40		1 57226 47 0	174	191	44		1 57378 90 0	177	192	50	
1 57030 60 0	173	191	41		1 57226 50 0	174	191	44		1 57409 30 1	584			
1 57030 62 0	173	191	41		1 57226 52 0	174	191	44		1 57410 30 1	446	458	12	
1 57030 70 0	173	191	41		1 57226 60 0	174	191	44		1 57410 35 1	446	458	12	
1 57033 60 0	344	388	41		1 57226 62 0	174	191	44		1 57411 30 1	584			
1 57035 60 0	174	191	42		1 57230 45 0	347	389	49		1 57411 31 1	584			
1 57035 62 0	174	191	42		1 57230 46 0	347	389	49		1 57415 30 1	446	458	13	
1 57035 70 0	174	191	42		1 57230 50 0	347	389	49		1 57415 35 1	446	458	13	
1 57152 60 1	351	388	42		1 57230 51 0	347	389	49		1 57415 35 2	446	458	13	
1 57152 60 2	351	388	42		1 57230 60 0	347	389	49		1 57416 30 1	584			
1 57157 60 1	351	388	42		1 57230 61 0	347	389	49		1 57416 31 1	584			
1 57157 60 2	351	388	42		1 57250 60 0	343	389	50		1 57424 30 1	585			
1 57162 60 1	351	388	42		1 57250 61 0	343	389	50		1 57429 30 1	585			
1 57162 60 2	351	388	42		1 57255 60 0	343	389	51		1 57505 28 0	417	457	6	
1 57167 60 1	352	388	42		1 57255 61 0	343	389	51		1 57505 38 0	417	457	6	
1 57167 60 2	352	388	42		1 57256 60 0	343	389	52		1 57506 28 0	417	457	6	
1 57172 60 1	351	388	42		1 57260 60 0	345	389	53		1 57515 25 0	418	457	7	
1 57172 60 2	351	388	42		1 57260 61 0	345	389	53		1 57515 27 0	418	457	7	
1 57177 60 1	352	388	42		1 57265 60 0	345	389	54		1 57515 28 0	418	457	7	
1 57177 60 2	352	388	42		1 57265 61 0	345	389	54		1 57515 32 0	418	457	7	
1 57192 00 0	352	388	43		1 57291 45 0	348	386	21		1 57515 38 0	418	457	7	
1 57210 40 0	346	388	44		1 57291 50 0	348	386	21		1 57515 48 0	418	457	7	
1 57210 45 0	346	388	44		1 57291 60 0	348	386	21		1 57515 68 0	418	457	7	
1 57210 50 0	346	388	44		1 57296 45 0	348	386	22		1 57516 28 0	418	457	7	
1 57210 60 0	346	388	44		1 57296 50 0	348	386	22		1 57516 38 0	418	457	7	
1 57211 40 0	346	388	44		1 57296 51 0	348	386	22		1 57517 28 0	418	457	7	
1 57211 41 0	346	388	44		1 57296 60 0	348	386	22		1 57517 38 0	418	457	7	
1 57211 45 0	346	388	44		1 57296 61 0	348	386	22		1 57525 28 0	419	457	8	
1 57211 46 0	346	388	44		1 57298 45 0	383				1 57526 28 0	419	457	8	
1 57211 50 0	346	388	44		1 57298 46 0	383				1 57535 28 0	420	457	9	
1 57211 51 0	346	388	44		1 57298 50 0	383				1 57535 48 0	420	457	9	
1 57211 60 0	346	388	44		1 57298 51 0	383				1 57535 68 0	420	457	9	
1 57211 61 0	346	388	44		1 57298 60 0	383				1 57535 88 0	420	457	9	
1 57215 45 0	346	388	45		1 57298 61 0	383				1 57536 28 0	420	457	9	
1 57215 46 0	346	388	45		1 57312 73 0	244	311	66		1 57655 28 A	412	457	6	
1 57215 50 0	346	388	45		1 57313 72 0	176	191	45		1 57655 32 A	412	457	6	
1 57215 51 0	346	388	45		1 57313 73 0	176	191	45		1 57655 38 A	412	457	6	
1 57215 60 0	346	388	45		1 57317 71 0	244	311	67		1 57655 48 A	412	457	6	
1 57215 61 0	346	388	45		1 57317 73 0	244	311	67		1 57655 58 A	412	457	6	
1 57217 45 0	347	388	46		1 57318 72 0	176	192	46		1 57665 28 A	412	457	7	
1 57217 50 0	347	388	46		1 57318 73 0	176	192	46		1 57665 38 A	412	457	7	
1 57217 60 0	347	388	46		1 57320 73 0	244	311	68		1 57665 48 A	412	457	7	
1 57218 45 0	383				1 57325 73 0	245	311	69		1 57665 58 A	416	457	7	
1 57218 46 0	383				1 57335 73 0	245	311	70		1 57675 28 A	414	457	8	
1 57218 50 0	383				1 57336 70 0	176	192	47		1 57675 48 A	414	457	8	
1 57218 51 0	383				1 57352 10 0	246	311	71		1 57685 28 A	414	457	9	
1 57218 60 0	383				1 57352 90 0	246	311	71		1 57685 48 A	414	457	9	
1 57218 61 0	383				1 57353 90 0	176	192	48		1 57765 28 0	425	458	10	
1 57219 50 0	383				1 57357 10 0	247	311	72		1 57765 48 0	425	458	10	
1 57220 40 0	347	389	47		1 57357 11 0	247	311	72		1 57766 28 0	425	458	10	
1 57220 45 0	347	389	47		1 57357 90 0	247	311	72		1 57766 48 0	425	458	10	
1 57220 50 0	347	389	47		1 57357 91 0	247	311	72		1 57787 48 0	434	458	11	
1 57220 60 0	347	389	47		1 57358 90 0	177	192	49		1 57788 48 0	434	458	11	
1 57223 40 0	174	191	43		1 57358 92 0	177	192	49		1 57831 45 0	358	386	29	
1 57223 42 0	174	191	43		1 57360 10 0	247	311	73		1 57831 46 0	358	386	29	
1 57223 45 0	174	191	43		1 57360 90 0	247	311	73		1 57831 50 0	358	386	29	
1 57223 50 0	174	191	43		1 57365 10 0	247	312	74		1 57831 51 0	358	386	29	
1 57223 52 0	174	191	43		1 57365 11 0	247	312	74		1 57831 60 0	358	386	29	

ITEM	PAGE	DRAWING		ITEM	PAGE	DRAWING		ITEM	PAGE	DRAWING		ITEM	PAGE	DRAWING	
		Page	Table			Page	Table			Page	Table			Page	Table
1 59711 00 0 C2	537	547	15	1 8A050 43 0	580	590	2	1 82410 51 0	573	589	1				
1 59711 00 0 C2 00 FR	477	547	15	1 82010 10 0	572	589	1	1 82410 52 0	573	589	1				
1 59711 01 0	537	547	15	1 82010 11 0	572	589	1	1 82410 70 0	573	589	1				
1 59711 01 0 00 00 FR	477	547	15	1 82010 20 0	572	589	1	1 82410 71 0	573	589	1				
1 59711 06 0	537	547	15	1 82010 21 0	572	589	1	1 82410 72 0	573	589	1				
1 59711 06 0 00 00 FR	477	547	15	1 82010 30 0	572	589	1	1 82410 80 0	573	589	1				
1 59711 06 0 00 SB FR	477	547	15	1 82010 31 0	572	589	1	1 82410 81 0	573	589	1				
1 59711 06 0 C2 00 FR	477	547	15	1 82010 32 0	572	589	1	1 82410 82 0	573	589	1				
1 59711 06 0 00 SB	537	547	15	1 82010 40 0	572	589	1	1 82410 90 0	573	589	1				
1 59711 06 0 C2	537	547	15	1 82010 41 0	572	589	1	1 82410 91 0	573	589	1				
1 59711 10 0	537	547	15	1 82010 42 0	572	589	1	1 82410 92 0	573	589	1				
1 59711 10 0 00 SB	537	547	15	1 82010 50 0	572	589	1	1 82450 34 0	579	590	2				
1 59711 10 0 00 SB FR	477	547	15	1 82010 51 0	572	589	1	1 82450 43 0	579	590	2				
1 59711 10 0 00 00 FR	477	547	15	1 82010 52 0	572	589	1	1 82450 53 0	579	590	2				
1 59711 10 0 C2	537	547	15	1 82010 70 0	572	589	1	1 82450 74 0	579	590	2				
1 59711 11 0	537	547	15	1 82010 71 0	572	589	1	1 82450 85 0	579	590	2				
1 59711 11 0 00 00 FR	477	547	15	1 82010 72 0	572	589	1	1 82450 95 0	579	590	2				
1 59711 16 0	537	547	15	1 82010 80 0	572	589	1	1 82710 30 0	571	589	1				
1 59711 16 0 00 SB	537	547	15	1 82010 81 0	572	589	1	1 82710 31 0	571	589	1				
1 59711 16 0 00 SB FR	477	547	15	1 82010 82 0	572	589	1	1 82710 32 0	571	589	1				
1 59711 16 0 00 00 FR	477	547	15	1 82010 90 0	572	589	1	1 82710 40 0	571	589	1				
1 59711 16 0 C2	537	547	15	1 82010 91 0	572	589	1	1 82710 41 0	571	589	1				
1 59751 00 0 00 00 FR	469	547	15	1 82010 92 0	572	589	1	1 82710 42 0	571	589	1				
1 59751 01 0 00 00 FR	469	547	15	1 82050 34 0	578	590	2	1 82710 50 0	571	589	1				
1 59801 10 0	494	545	10	1 82050 43 0	578	590	2	1 82710 51 0	571	589	1				
1 59801 11 0	494	545	10	1 82050 53 0	578	590	2	1 82710 52 0	571	589	1				
1 59811 09 0	494	545	10	1 82050 74 0	578	590	2	1 82710 70 0	571	589	1				
1 59811 10 0	494	545	10	1 82050 85 0	578	590	2	1 82710 71 0	571	589	1				
1 59811 10 0 00SB	495	545	10	1 82050 95 0	578	590	2	1 82710 72 0	571	589	1				
1 59811 10 0 C2	494	545	10	1 82210 20 0	573	589	1	1 82710 80 0	571	589	1				
1 59811 11 0	494	545	10	1 82210 21 0	573	589	1	1 82710 81 0	571	589	1				
1 59811 11 0 C2	494	545	10	1 82210 30 0	573	589	1	1 82710 82 0	571	589	1				
1 59816 10 0	495	545	10	1 82210 31 0	573	589	1	1 82710 90 0	571	589	1				
1 59816 11 0	495	545	10	1 82210 32 0	573	589	1	1 82710 91 0	571	589	1				
1 59851 09 0	493			1 82210 40 0	573	589	1	1 82710 92 0	571	589	1				
1 59851 10 0	493			1 82210 41 0	573	589	1	1 82750 34 0	576	590	2				
1 59851 10 0 C2	493			1 82210 42 0	573	589	1	1 82750 43 0	576	590	2				
1 59851 11 0	493			1 82210 50 0	573	589	1	1 82750 53 0	576	590	2				
1 60130 01 0 98	564	567	1	1 82210 51 0	573	589	1	1 82750 74 0	576	590	2				
1 60131 01 0 98	564	567	1	1 82210 52 0	573	589	1	1 82750 85 0	576	590	2				
1 60140 02 0 98	564	567	1	1 82210 70 0	573	589	1	1 82750 95 0	576	590	2				
1 60141 02 0 98	564	567	1	1 82210 71 0	573	589	1	1 82751 35 0	577	590	2				
1 60150 03 0 98	564	567	1	1 82210 72 0	573	589	1	1 82751 75 0	577	590	2				
1 60151 03 0 98	564	567	1	1 82210 80 0	573	589	1	1 83000 40 0	574	590	3				
1 60160 04 0 98	564	567	1	1 82210 81 0	573	589	1	1 83000 41 0	574	590	3				
1 60161 04 0 98	564	567	1	1 82210 82 0	573	589	1	1 83010 40 0	574	590	3				
1 72210 16 0	119	127	18	1 82210 90 0	573	589	1	1 83710 40 0	574	590	3				
1 72210 20 0	119	127	18	1 82210 91 0	573	589	1								
1 72210 25 0	119	127	18	1 82210 92 0	573	589	1								
1 72210 30 0	119	127	18	1 82250 34 0	579	590	2								
1 72215 16 0	120	127	18	1 82250 43 0	579	590	2								
1 72215 20 0	120	127	18	1 82250 53 0	579	590	2								
1 72215 25 0	120	127	18	1 82250 74 0	579	590	2								
1 72250 26 0	120	128	19	1 82250 85 0	579	590	2								
1 72251 01 0	120	128	20	1 82250 95 0	579	590	2								
1 72251 03 0	120	128	20	1 82410 20 0	573	589	1								
1 8A010 20 0	575	589	1	1 82410 21 0	573	589	1								
1 8A010 21 0	575	589	1	1 82410 30 0	573	589	1								
1 8A010 30 0	575	589	1	1 82410 31 0	573	589	1								
1 8A010 31 0	575	589	1	1 82410 32 0	573	589	1								
1 8A010 40 0	575	589	1	1 82410 40 0	573	589	1								
1 8A010 41 0	575	589	1	1 82410 41 0	573	589	1								
1 8A050 23 0	580	590	2	1 82410 42 0	573	589	1								
1 8A050 34 0	580	590	2	1 82410 50 0	573	589	1								



CISA™

Special executions

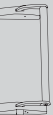
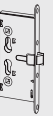

SPECIAL FINISHES	Nickel-plated 12	Bronze-plated visible parts 47	Polished visible parts 66
<p>CYLINDERS</p> <ul style="list-style-type: none"> • Single rim cylinders - Cam locks and furniture cylinders • Rim cylinder sets - Double cylinders (standard, with tumb turn shaft) • Single mortice cylinders (standard, with tumb turn shaft) • Double cylinders with round knob, Hotel Function <p>ROSES:</p> <ul style="list-style-type: none"> • 06010 - 06011 - 06012 - 06018 - 06027 • 06043 - 06081 - 06082 - 06083 - 06143 <p>LOCKS (visible parts):</p> <ul style="list-style-type: none"> • 12010 - 12011 - 12015 - 12016 - 5C012 - 5C032 - 52210 - 52300 - 52310 - 52520 - 52521 - 52526 • 45100 • 5C110 - 5C120 - 5C130 - 5C140 - 5C150 - 5C170 • 5C611 - 5C631 <p>STRIKERS</p>	<ul style="list-style-type: none"> • • • - • • • • • • • • 	<ul style="list-style-type: none"> - - - - • - - • • - • • 	<ul style="list-style-type: none"> - • • - - - - - - - - -
<p>BUTTON ART. 1.06110.00.0</p>	<ul style="list-style-type: none"> • 	<ul style="list-style-type: none"> - 	<ul style="list-style-type: none"> -

41	43	44	45	97	B9
red RAL 3000	green RAL 6001	black RAL 9005	white RAL 9010	grey RAL 9006	steel grey

SPECIAL FINISHES

FAST PANIC EXIT DEVICES

• **eFAST Touch 59851 series**

- White casing White bar Fin. 45.....
- Grey casing Grey bar Fin. 97.....
- St. steel grey casing ... St. steel grey bar Fin. B9.....

• **FAST Touch item 59811.10.0, 59711.00.0, 59711.10.0**

- Black casing Black bar Fin. 44.....
- White casing White bar Fin. 45.....
- Grey casing Grey bar Fin. 97.....
- St. steel grey casing ... St. steel grey bar Fin. B9.....

• **FAST Touch item 59811.10.0.00.00.SB, 59711.00/10.0.00.00.SB (casing fin.)**

- Black casing Fin. 44.....
- White casing Fin. 45.....
- Grey casing Fin. 97.....

• **FAST Push series 59011, 59066 and Prestige series 59311, 59607, 59617.XX**

- White casing Fin. 45.....
- Grey casing Fin. 97 (*) Surcharge for Prestige series only.....
- St. steel grey casing ... Fin. B9(**) Not available for 59617 series.....



• **Additional locking points and components for FAST and Prestige series**

- Set of latchbolt item 1. 07063-20/30/35/40/51/53/61/63/66 (Fin 45) (Fin. 97-B9)
- Inside plate item 07176.60/61/62/63/70/71.0 (Fin 45-97).....
- Set for top rod extensions item 1.07081.06.0 (Fin 45-97).....
- Kit of vertical rod item 1.07064.51/61/71.0 (Fin 45-97-B9).....
- Hold open devices item 1.07165.50/51.0 (Fin 45-97-B9).....
- Strikers series 07072 (Fin 45-97-B9).....
- Horizontal bar item 07007.13/14/15.0(Fin 41-42-44-45-97-B9).....
- Outside operation devices item 07078 (Fin 45-97-B9).....
- Electric strikers item 1.07083.05/06/07/40/41/80/81/82/90 (Fin 45-97-B9)



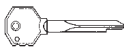
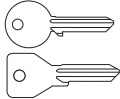

• **FAST Flow panic exit devices art. 1.59014.10.0**



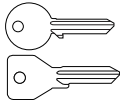
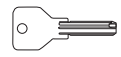
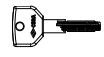

- White casing (panic exit device, latchbolt set and rod) Fin. 45.....
- Grey casing (panic exit device, latchbolt set and rod) Fin. 97.....
- St. steel grey casing (panic exit device, latchbolt set and rod)fin B9

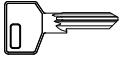

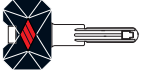
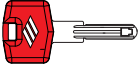





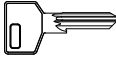

SPECIAL KEYING ARRANGEMENTS	CROSS KEY	STANDARD C2000	Asix	AsixP8
				
<p>KEYED ALIKE SYSTEMS</p> <p>A) KEY-CHANGES AT OUR CHOICE</p> <ul style="list-style-type: none"> - Padlocks, rim locks with single cylinder, single cylinders, single rim cylinders, cylinders with knob, cross key cylinders..... - Rim locks with double cylinder, double cylinders, rim cylinder sets..... <p style="text-align: right;">KA</p> <p>KA CODED (specify code in order)</p> <ul style="list-style-type: none"> - Padlocks, rim locks with single cylinder, Single mortice cylinder single rim cylinders, cylinder with knob, cross key cylinder - Rim locks with double cylinder, double cylinders, , rim cylinder sets..... <p style="text-align: right;">KC</p> <p><i>(*) Cylinder supplied with one key.</i></p>	<p>• (*)</p> <p>-</p> <p>• (*)</p> <p>-</p>	<p>•</p> <p>•</p> <p>•</p> <p>•</p>	<p>•</p> <p>•</p> <p>•</p> <p>•</p>	<p>•</p> <p>•</p> <p>•</p> <p>•</p>
<p>KEYS WITH A DIFFERENT NUMBER THAN THE STANDARD (specify number in order)</p> <ul style="list-style-type: none"> - Less than standard number DEDUCTION (for each key), WHERE AVAILABLE - More than standard number SURCHARGE (for each key) 	<p>-</p> <p>-</p>	<p>•</p> <p>•</p>	<p>•</p> <p>•</p>	<p>•</p> <p>•</p>
<p>MASTER KEY SYSTEMS MK - GMK - GGMK <small>Key code numbering, as standard. Cylinder code numbering, as standard only for Astral Tekno PRO, AP4 S, RS5 and RX serie)</small></p> <p>A) KEY-CHANGES AT OUR CHOICE</p> <ul style="list-style-type: none"> - Padlocks, rim locks with single cylinder, single cylinders, single rim cylinders, cylinders with knob..... - Rim locks with double cylinder, double cylinders, rim cylinder sets..... <p style="text-align: right;">MK</p> <p>MK CODED FOR EXTENSIONS (specify system code in order)</p> <ul style="list-style-type: none"> - Padlocks, rim locks with single cylinder, single cylinders, single rim cylinders, cylinders with knob - Rim locks with double cylinder, double cylinders, rim cylinder sets. <p>B) MASTER KEY</p> <p>C) SECURICARD RS5 (1.00820.80.0.00.00.MK)</p> <p>D) SECURICARD RX (1.00830.80.0.00.00.MK)</p>	<p>-</p> <p>-</p> <p>-</p> <p>-</p> <p>-</p> <p>-</p> <p>-</p> <p>-</p>	<p>•</p> <p>•</p> <p>•</p> <p>•</p> <p>•</p> <p>•</p> <p>•</p> <p>•</p>	<p>•</p> <p>•</p> <p>•</p> <p>•</p> <p>•</p> <p>•</p> <p>•</p> <p>•</p>	<p>•</p> <p>•</p> <p>•</p> <p>•</p> <p>•</p> <p>•</p> <p>•</p> <p>•</p>

<p>SPECIAL KEYING ARRANGEMENTS</p>	<p>STANDARD C2000</p>	<p>Asix</p>	<p>AsixP8</p>
			
<p>1-2 SYSTEM PLUS CONSTRUCTION KEY (available with RS5 only) <i>Set of keys supplied as standard 1+3+1: includes one black lozenge construction key, three red LEVEL 1 lozenge keys and one white LEVEL 2 lozenge key. Dedicated SECURICARD for every level. Different sets of keys are available on request</i></p> <p style="text-align: right;">3C</p> <p>1-2 SYSTEM PLUS CONSTRUCTION KEY (available with AP4 S) <i>Standard supply 1+3+1: one construction key (black wings), three keys LEVEL 1 (red wings), one key LEVEL 2 (green wings)</i></p> <p><i>Each level is supplied with its specific Security Card</i> <i>Different number of keys can be supplied upon request.</i></p> <ul style="list-style-type: none"> - Single cylinders, cylinder with knob - Double cylinders 	<p style="text-align: center;">-</p> <p style="text-align: center;">-</p>	<p style="text-align: center;">-</p> <p style="text-align: center;">-</p>	<p style="text-align: center;">-</p> <p style="text-align: center;">-</p>
<p>1-2-3 SYSTEM PLUS CONSTRUCTION KEY (available with AP4 S)</p> <p><i>Standard supply 3+1+1: three keys LEVEL 1 (red wings), one key LEVEL 2 (green wings), one key LEVEL 3 (orange wings)</i></p> <p style="text-align: right;">3L</p> <p><i>Each level is supplied with its specific Security Card</i></p> <p><i>Different number of keys can be supplied upon request.</i></p> <ul style="list-style-type: none"> - Single cylinders, cylinder with knob - Double cylinders 	<p style="text-align: center;">-</p> <p style="text-align: center;">-</p>	<p style="text-align: center;">-</p> <p style="text-align: center;">-</p>	<p style="text-align: center;">-</p> <p style="text-align: center;">-</p>
<p>Key code numbering, as standard. Cylinder code numbering, as standard only for Astral Tekno, Astral Tekno PRO, AP4 S and RS5 and RX series.</p> <p>CE SYSTEM OWNER / SERVICE SYSTEM</p> <p style="text-align: right;">CE</p> <p>A) KEY-CHANGES AT OUR CHOICE</p> <ul style="list-style-type: none"> - Padlocks, rim locks with single cylinder, single cylinders, single rim cylinders, cylinders with knob, cross key cylinders.. - Rim locks with double cylinder, double cylinders, rim cylinder set <p>B) CODED (specify system code or key biting in order)</p> <ul style="list-style-type: none"> - Padlocks, rim locks with single cylinder, single cylinders, single rim cylinders, cylinders with knob - Rim locks with double cylinder, double cylinders, rim cylinder set <p>N.B. If requested: add surcharge for cylinder body numbering or special numberings.</p>	<p style="text-align: center;">●</p> <p style="text-align: center;">●</p> <p style="text-align: center;">●</p> <p style="text-align: center;">●</p>	<p style="text-align: center;">●</p> <p style="text-align: center;">●</p> <p style="text-align: center;">●</p> <p style="text-align: center;">●</p>	<p style="text-align: center;">●</p> <p style="text-align: center;">●</p> <p style="text-align: center;">●</p> <p style="text-align: center;">●</p>
<p>CONSTRUCTION KEY SYSTEMS:</p> <p style="text-align: right;">CA</p> <ul style="list-style-type: none"> • Master key systems <i>The construction master key opens all the cylinder until the individual or master one is used, which cancels it definitively</i> <ul style="list-style-type: none"> - Single cylinder, cylinder with knob - Double cylinder - Master construction key <p><i>If Master Keys are not required, CISA recommends the "Single Cylinder"</i></p> • Single Cylinder (Surcharge must be added to the cylinder price as appropriate). <i>Each cylinder has construction key (marked C) and 3 owner's key.</i> <i>The construction key opens the cylinder until the owner's one is used.</i> <ul style="list-style-type: none"> - Single cylinder, cylinder with knob,(construction key included) - Double cylinder (construction key included) 	<p style="text-align: center;">●</p> <p style="text-align: center;">●</p> <p style="text-align: center;">●</p> <p style="text-align: center;">-</p> <p style="text-align: center;">-</p>	<p style="text-align: center;">-</p> <p style="text-align: center;">-</p> <p style="text-align: center;">-</p> <p style="text-align: center;">-</p>	<p style="text-align: center;">●</p> <p style="text-align: center;">●</p> <p style="text-align: center;">●</p> <p style="text-align: center;">●</p>

Astral Astral S		C3000 C3000S		Astral Tekno PRO	AP4 S	RS5	RX
 Short key	 Long key						
- -	- -	- -	- -	- -	• •	• •	• •
- -	- -	- -	- -	- -	• •	• •	• •
• • • •	• • • •	• • • •	• • • •	• • • •	• • • •	• • • •	• • • •
• • •	• • •	• • •	• • •	• • •	• • •	• • •	• • •
• •	• •	• •	• •	• •	• •	• •	• •

KEYS OPTIONS	STANDARD C2000	Asix	AsixP8	Astral Astral S	
					
				Short key	Long key
BITTED KEYS IN ADDITION TO STANDARD SUPPLY.					
different key supply (specify the total number of keys) CH	•	-	•	•	•
CYLINDERS SUPPLIED WITH 3 LONG KEYS CL	-	-	-	-	•
KEY DUPLICATION AND SECURITY CARD.					
KEYS C2000, SP, ASIX, ASIXP8, ASTRAL, ASTRAL-S ORDERED SEPARATELY BY QUOTING THE KEY BITTING CODE OR CODE CARD / PERSONAL CARD/ ORDERED AS PER SAMPLE	•	•	•	•	•
C3000 - C3000 S KEYS ORDERED SEPARATELY WITH SECURITY CARD (code 1.00430.00.1.00.00.KC).....	-	-	-	-	-
SECURITY CARD C3000 - C3000 S ORDERED ACCORDING TO EXISTING PROCEDURE 1.00430.80.0.00.00.KC	-	-	-	-	-
TSP KEYS ORDERED SEPARATELY WITH SECURITY CARD (TSP short key code 1.00500.01.1.00.00.KC), (TSP long key code 1.00500.90.1.00.00.KC)	-	-	-	-	-
SECURITY CARD TSP ORDERED ACCORDING TO EXISTING PROCEDURE 1.00500.80.0.00.00.KC	-	-	-	-	-
ASTRAL TEKNO, ASTRAL TEKNO PRO KEYS ORDERED SEPARATELY WITH SECURITY CARD (1.00690.00.0.00.CL.KC) ..	-	-	-	-	-
SECURITY CARD ASTRAL TEKNO, ASTRAL TEKNO PRO ORDERED ACCORDING TO EXISTING PROCEDURE 1.00690.80.0.00.00.KC ..	-	-	-	-	-
AP4 S KEYS ORDERED SEPARATELY WITH SECURITY CARD, code 1.00810.00.0.00.00.KC	-	-	-	-	-
SECURITY CARD AP4 S 1.00810.80.0.00.00.KC ORDERED ACCORDING TO EXISTING PROCEDURE	-	-	-	-	-
RS3 S KEYS ORDERED SEPARATELY WITH SECURITY CARD (RS3 S CODE 1.00800.00.0.00.CL.KC)	-	-	-	-	-
SECURITY CARD RS3 S ORDERED ACCORDING TO EXISTING PROCEDURE 1.00800.80.0.00.00.KC	-	-	-	-	-
RS5 KEYS ORDERED SEPARATELY WITH SECURICARD (RS5 CODE 1.00820.00.0.00.00.KC)	-	-	-	-	-
SECURICARD ORDERED ACCORDING TO EXISTING PROCEDURE	-	-	-	-	-
RX KEYS ORDERED SEPARATELY WITH SECURICARD (RX CODE 1.00830.00.0.00.00.KC)	-	-	-	-	-
SECURICARD ORDERED ACCORDING TO EXISTING PROCEDURE	-	-	-	-	-
NOTE					
• Copies of keys or of Security Cards TSP, AP4 S and RS3 S must be requested by submitting specific orders.					
• Copies of keys or SecuriCards must be requested using the specific new procedure.					
• Shipping by express courier. Any additional forwarding charges shall be at the customer's expense.					
• Key delivery time: 5 working days from order date for orders up to 10pcs (shipping time excluded); for larger orders, delivery shall be agreed upon.					
<small>In case of theft or loss of the SecuriCard, a replacement card can be requested only if the account had been previously activated. The replacement card cancels the previous cards and inherits the history of operations done. If the account had not been activated, replace the cylinder.</small>					
• CYLINDERS WITH PERSONALIZED KEYWAY (specify on order form) PP					
- Cylinders (for cylinder locks, order cylinder separately)	•	-	-	-	-
- Key	•	-	-	-	-
C2000, C3000, C3000S, ASTRAL-S, ASTRAL TEKNO PRO Cylinders (min 200 pcs first order), 30 PCS SECOND ORDER ASIXP8 Cylinders (min 500 pcs first order), 200 PCS SECOND ORDER					
• KEY COINING (CS) OR INSERT (CP) FOR PERSONALIZED KEYBOW (ONE SIDE ONLY).					
Minimum quantity:					
C2000, ASIX keys 3.000 pcs - C2000, ASIX cylinder 1.000 pcs	•	•	-	-	-
- ASTRAL S, C3000, C3000S keys 2.000 pcs - ASTRAL S, C3000, C3000S cylinder 1.000 pcs CS					
- AP4 S keys See Solution Partner program - AP4 S cylinder See Solution Partner program					
- RX keys See Red eXpert program - RX cylinder Red eXpert program					
- ASTRAL TEKNO PRO keys 500 pcs - ASTRAL TEKNO PRO cylinder 200 pcs					
- ASIXP8 keys 1000 pcs - ASIXP8 cylinder 500 pcs CP					

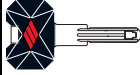
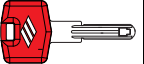
SP		C3000 C3000S	TSP		Astral Tekno PRO	AP4 S	RS3 S	RS5	RX
									
Short key	Long key		Short key	Long key					
-	-	•	-	-	•	•	•	•	•
-	•	-	-	-	-	-	-	-	-
•	•	-	-	-	-	-	-	-	-
-	-	•	-	-	-	-	-	-	-
-	-	•	-	-	-	-	-	-	-
-	-	-	•	•	-	-	-	-	-
-	-	-	•	•	-	-	-	-	-
-	-	-	-	-	•	-	-	-	-
-	-	-	-	-	•	-	-	-	-
-	-	-	-	-	-	•	-	-	-
-	-	-	-	-	-	•	•	-	-
-	-	-	-	-	-	-	-	•	-
-	-	-	-	-	-	-	-	•	•
-	-	-	-	-	-	-	-	-	•
•	•	-	-	-	-	-	-	-	-
-	-	-	-	-	-	-	-	-	-
-	-	-	-	-	-	-	-	-	-
-	-	-	-	-	-	-	-	-	-
-	-	-	-	-	-	-	-	-	-
-	-	-	-	-	-	-	-	-	-
-	-	-	-	-	-	-	-	-	-
-	-	-	-	-	-	-	-	-	-
-	-	-	-	-	-	-	-	-	-

SPECIAL EXECUTIONS

SPECIAL KEYING ARRANGEMENTS		
	DOUBLE-BIT KEY MORTICE LOCKS	
	SINGLE LOCKS	TWIN LOCKS
<p>IKEYED ALIKE SYSTEMS</p> <p>A) KEY-CHANGES AT OUR CHOICE KA</p> <p>KA WITH A DIFFERENT NUMBER OF KEYS THAN THE STANDARD (specify number in order)</p> <ul style="list-style-type: none"> - Less than standard number - More than standard number <p>B) CODED (specify system code or key biting in order) KC</p>	<p>•</p> <p>•</p> <p>•</p> <p>•</p>	<p>•</p> <p>•</p> <p>•</p> <p>•</p>

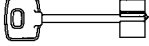
ADDITIONAL BITTED KEYS		
	Key item	
<p>BITTED KEYS IN ADDITION TO STANDARD SUPPLY specify the total number of keys CH</p> <p>For REKEYABLE LOCKS " "</p> <p>For DOUBLE BIT CYLINDERS " "</p> <p>For DOUBLE BIT CYLINDERS for REKEYABLE locks " " "</p>	<p>00100</p> <p>00101</p> <p>00102</p> <p>00104</p> <p>00110</p> <p>00112</p> <p>00120</p> <p>00121</p> <p>00122</p> <p>00123</p> <p>00125</p> <p>00162</p> <p>00163</p> <p>00162</p> <p>00163</p> <p>00162</p> <p>00163</p>	<p>•</p> <p>•</p> <p>•</p> <p>•</p> <p>•</p> <p>•</p> <p>•</p> <p>•</p> <p>•</p> <p>•</p> <p>•</p> <p>•</p> <p>•</p> <p>•</p> <p>•</p> <p>•</p> <p>•</p>



DOUBLE-BIT KEY MORTICE LOCKS	DOUBLE-BIT KEY RIM LOCKS	DOUBLE BIT CYLINDER for 6-LEVER DOUBLE-BIT KEY LOCKS	DOUBLE BIT CYLINDER for 6-LEVER DOUBLE-BIT KEY LOCKS, REKEYABLE
with KEY 00110	with KEY 00125		
• • • •	• • • •	• • • •	• • • •

**KEY DUPLICATION
00162, 00163**

() Keys duplicated by CISA only*

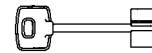

	For REKEYABLE locks			For DOUBLE BIT CYLINDERS on 6-LEVER ARMoured DOOR LOCKS (*)		For DOUBLE BIT CYLINDERS on REKEYABLE LOCKS (*)	
			KEYING ON SHAFT	KEYING ON SHAFT AND KEY BITS		KEYING ON SHAFT AND KEY BITS	
	A) Ordered separately by code	•	•	-	-		
B) Ordered as per sample	•	-	•	•		•	

NUMBERING	CN NUMBERING DEFINED BY CISA (with reference to the key bitting)	NPN NUMBERING DEFINED BY CUSTOMER
<ul style="list-style-type: none"> • PADLOCK..... • CYLINDER..... • 1 KEY..... 	<ul style="list-style-type: none"> • • • 	<ul style="list-style-type: none"> • • •

PRODUCTS WITH ARRANGEMENTS DIFFERENT THAN THE STANDARD ONE	
<p>PANIC EXIT DEVICES SERIES 59001, 59011, 59061, 59301, 59311, 59361, 59801, 59811, 59851</p> <ul style="list-style-type: none"> - Version with steel latches, for fire doors (Spec FR) - Additional locking points item 1.07063.20/30/35/51/61/66.0 with steel latch bolt for fire resistant doors (Spec. FR) - Version with hold open device (not for 59851 series) (Spec FG) - Version with microswitch (not for 59851 series) (Spec LA)..... 	<ul style="list-style-type: none"> • • • •

CYLINDERS AND PADLOCKS SUPPLIED IN UNASSEMBLED VERSIONS

Cylinders and padlocks are available in **UNASSEMBLED** versions :

- **“UNASSEMBLED”** (completely unassembled)

N.B. keys, pins, drivers, springs, pin hole plugs, circlips, are to be ordered separately

CYLINDERS	UNASSEMBLED 91				
	C2000	C3000 C3000S	AsixP8	Astral	Astral Tekno Pro
• Euro profile double cylinders	•	•	•	•	•
• Euro profile single cylinders	•	•	•	•	•
• Euro profile thumb turn cylinders	•	•	•	•	•
• Rim cylinders, cam locks, furniture cylinders	•	•	•	•	•
• Rim cylinder set	•	•	•	•	•
• Hardened steel padlock cylinders	-	•	•	•	•

BRASS PADLOCKS	STANDARD	LIM
• 22010-30/40	•	
• 22010-50/60	•	See PP

HARDENED STEEL PADLOCKS	
Hardened steel padlocks in UNASSEMBLED version are supplied without cylinder and without the cylinder and padlock drill resistant plate When ordering the padlock cylinder you must specify separately the relevant padlock drill resistant plate (the cylinder drill resistant plate is supplied as standard).	
• 28050-55/56/57, 28350-62, 28050-70/71/72, 28350-73, 28550-66/67/75/84/85	•

PADLOCKS WITH KEY ALIKE - AS PER SAMPLE (KS)	
• Padlocks series 22000 and 28000	•



Keys compatibility 48
 Key blanks - 1:1 scale 49

Double-bit key blanks 55

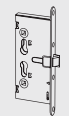
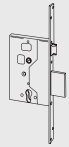

KEY BLANKS	CYLINDERS AND PADLOCKS
01060-10	41510 - 41525 - 41526
00770-00	0H112 - 0H149 - 0H155 - 0H210 - 0H310 - 0H311 - 0H312 - 0H314 - 0H317 - 0H350 - 0H351 - 0H352 - 0H357 - 0H410 - 0H510 - 0H610
00810-00	0P112 - 0P149 - 0P155 - 0P210 - 0P3S1 - 0P3S2 - 0P314 - 0P3S7 - 0P410 - 0P510 - 0P610
00210-00/11	02400
00401-00	26020-50/60 - series 28050 - 28350 - 28550 - 02650
00450-01/90	02163 - 02164 - 02172 - 02176 - 02179 - 02182 - 02502 - 02572 - 02652 - 08815 - 08835 08855 - 08857 - 08875 - 08887 - 72275 - 72276 - 28052 - 28352 - 28552
00500-01/90	02152 - 02162 - 02166 - 02169 - 02173 - 02174 - 02501 - 02562 - 02651 - 08810 - 08830 - 08850 - 08851 - 08870 - 08881 - 72270 72271 28051 - 28351 - 28551
00620-01/90	0A112 - 0A114 - 0A116 - 0A120 - 0A149 - 0A155 - 0A210 - 0A310 - 0A311 - 0A312 - 0A314 - 0A317 - 0A3S1 - 0A3S2 - 0A3S7 - 0A410 - 0A415 - 0A510 - 0A610 - 28053 - 28353 - 28553
01210-00	02520
01310-00/10/20/30/40	02102 - 02104 - 02106 - 02110 - 02139 - 02142 - 02145 - 02146 - 02500 - 02513 - 02550 - 02552 - 02592 - 02649 08710-07/08/10/12÷15/17÷30/35÷37/46 - 08730 22010-50/60 - 22011-50/52 - 22012-50 - 22013-50/60 - 72250
01070-10	0G300-07-08-10-12÷15-17÷70 - 0G301-07-12-13-26 - 0G304-02÷13-20-21 - 0G302 - 0G303 - 0G305 - 0G307 0G115 - 0G150 - 0G200 - 0G500 - 0G501
01320-00/10/20/30/40	02544-15 08710-04÷06/09/11/16 - 44010 - 44011
01070-05	0G300-04÷06-09/11/16 - 0G301-05-06-09-11 - 0G304-18
01330-00	02544-10/14 - 02126 - 02156
01070-01	0G300-02/03
01410-00	08210-02/05/06/12÷14/18 - 08220-02 - 08230-02/06 22010-40 - 22011-40/41 - 22012-40 - 22013-40 - 22070-40 - 26020-40 - 26021-40
01420-00	02040 - 02042 - 72010 - 72210 - 72215
01425-00	08210-01
01430-00	22010-30 - 22011-30/31 - 22012-30 - 22013-30 - 22070-30 - 26020-30
01440-00	22010-20/25 - 22011-20 - 22013-20/25 23010
01510-00	22010-15
00670-01	0E300 - 0E304 - 0E302 - 0E303 - 0E305 - 0E115 - 0E150 - 0E200 - 0E500 - 0E600 - 0E307
00670-10	0Q116 - 0Q120 - 0Q149 - 0Q150 - 0Q156 - 0Q210 - 0Q310 - 0Q311 - 0Q312 - 0Q314 - 0Q317 - 0Q510 - 0Q610 - 0Q410 - 0Q415 - 0Q3S1 - 0Q3S2 - 0Q3S7
00690-00-0-00-CL	0M112 - 0M156 - 0M311 - 0M312 - 0M314 - 0M317 - 0M510 - 0M410 - 0M610 - 0M3T1 - 0M3T2 - 0M3T7
00430-00-1	0N116 - 0N210 - 0N149 - 0N310 - 0N312 - 0N314 - 0N317 - 0N510 - 0N610 - 0N410 - 0N3S1 - 0N3S2 - 0N3S7

Type	Description	L	Pins	Unit weight	Pieces	ITEM				
						Type	Dim.	Hand	Fin.	Pers. Spec.
	<ul style="list-style-type: none"> Nickel-plated brass Paracentral keyway 	3	0,004	50	1	01040	01	1		
	<ul style="list-style-type: none"> Nickel-plated brass Paracentral keyway 	4	0,004	50	1	01040	02	1		
	<ul style="list-style-type: none"> Nickel-plated brass Paracentral keyway 	4	0,010	50	1	01040	03	1		
	<ul style="list-style-type: none"> Nickel-plated brass Paracentral keyway 	5	0,010	50	1	01040	04	1		
	<ul style="list-style-type: none"> Nickel-plated brass Paracentral keyway 	5	0,010	50	1	01040	05	1		
	<ul style="list-style-type: none"> Nickel-plated brass Paracentral keyway 	5	0,012	50	1	01060	10	0		
	<ul style="list-style-type: none"> Nickel-plated steel Cross key section 	75,0	6	0,018	25	1	00210	00	0	
	<ul style="list-style-type: none"> Nickel-plated steel Cross key section 	90,0	6	0,023	25	1	00211	00	0	
	<ul style="list-style-type: none"> Nickel-plated brass Paracentral keyway 	6	0,015	25	1	01210	00	2		

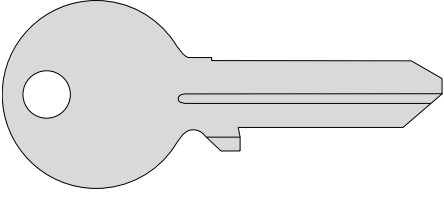
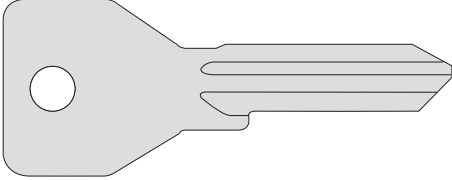
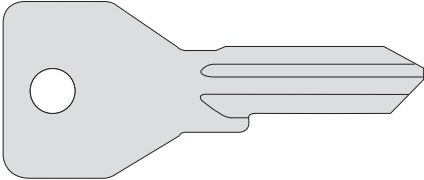
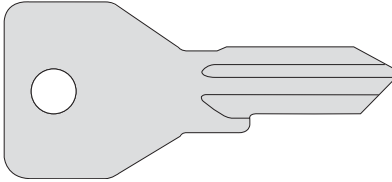
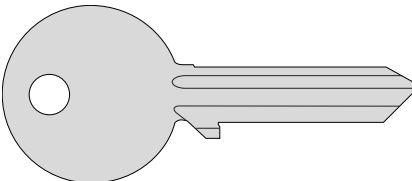
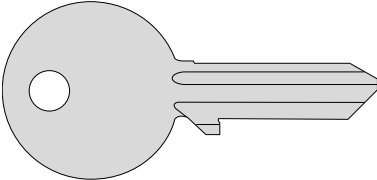
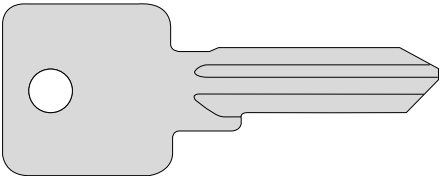
Type	Description	L	Pins	Unit weight	Pieces	ITEM				
						Type	Dim.	Hand	Fin.	Pers.
	<ul style="list-style-type: none"> Nickel-plated brass Paracentral keyway 	5	0,014	25	1	01220	00	2		
C2000 	<ul style="list-style-type: none"> Nickel-plated brass Paracentral keyway 	5	0,012	50	1	01070	10	1		
		5	0,013	50	1	01070	10	2		
C2000 	<ul style="list-style-type: none"> Nickel-plated brass Paracentral keyway 	4	0,012	50	1	01070	05	1		
		4	0,011	50	1	01070	05	2		
C2000 	<ul style="list-style-type: none"> Nickel-plated brass Paracentral keyway 	3	0,011	50	1	01070	01	1		
		3	0,011	50	1	01070	01	2		
	<ul style="list-style-type: none"> Nickel-plated brass Paracentral keyway 	5	0,010	50	1	01310	00	1		
		5	0,010	50	1	01310	00	2		
	<ul style="list-style-type: none"> Nickel-plated brass Paracentral keyway 	4	0,010	50	1	01320	00	1		
		4	0,010	50	1	01320	00	2		
	<ul style="list-style-type: none"> Nickel-plated brass Paracentral keyway 	5	0,014	50	1	01310	10	1		
		5	0,015	50	1	01310	10	2		

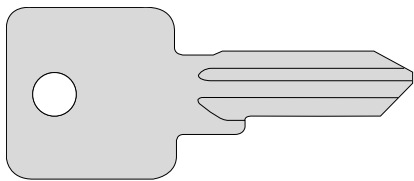
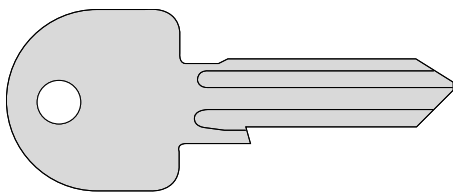
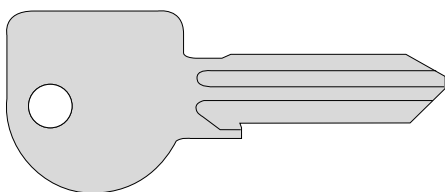
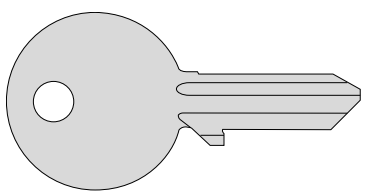
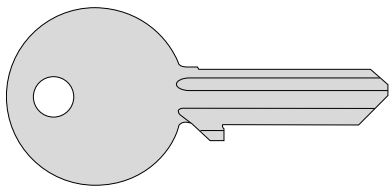
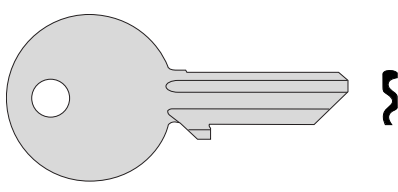
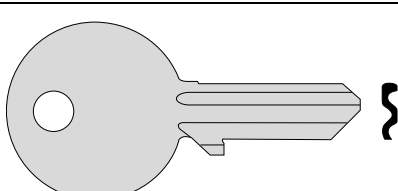
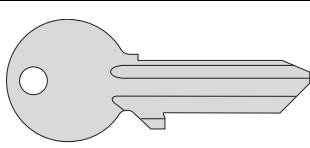
Type	Description	L	Pins	Unit weight	Pieces	ITEM				
						Type	Dim.	Hand	Fin.	Pers.
	<ul style="list-style-type: none"> Nickel-plated brass Paracentral keyway 					4	0,014	50	1 01320 10 1	
						4	0,013	50	1 01320 10 2	
	<ul style="list-style-type: none"> Blank key for master key duplication (MK) Nickel-plated brass Paracentral keyway 					5	0,014	50	1 01310 20 1	
						5	0,010	50	1 01310 20 2	
	<ul style="list-style-type: none"> Blank key for grand master key duplication (GMK) Nickel-plated brass Paracentral keyway 					5	0,014	50	1 01310 30 1	
						5	0,010	50	1 01310 30 2	
	<ul style="list-style-type: none"> Nickel-plated brass Paracentral keyway 					3	0,011	50	1 01330 00 1	
						3	0,010	50	1 01330 00 2	
	<ul style="list-style-type: none"> Nickel-plated brass Paracentral keyway 					5	0,007	50	1 01410 00 1	
						5	0,007	50	1 01410 00 2	
	<ul style="list-style-type: none"> Nickel-plated brass Paracentral keyway 					4	0,008	50	1 01420 00 1	
						4	0,008	50	1 01420 00 2	
	<ul style="list-style-type: none"> Nickel-plated brass Paracentral keyway 					3	0,007	50	1 01425 00 1	
						3	0,008	50	1 01425 00 2	
	<ul style="list-style-type: none"> Nickel-plated brass Paracentral keyway 					4	0,005	50	1 01430 00 1	
						4	0,005	50	1 01430 00 2	

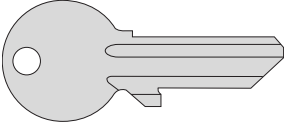
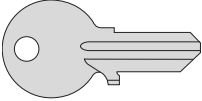
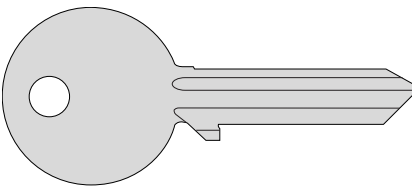
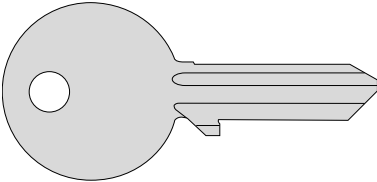
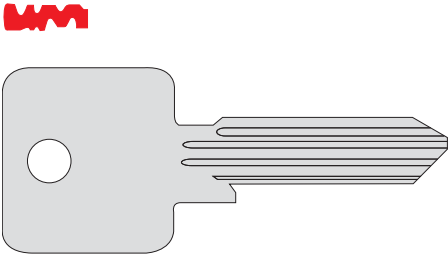
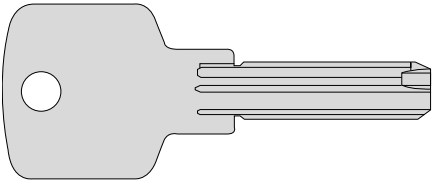
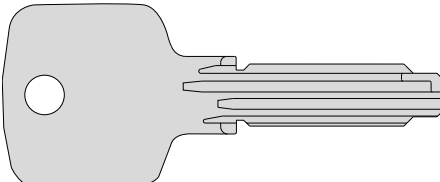
Type	Description	L	Pins	Unit weight	Pieces	ITEM				
						Type	Dim.	Hand	Fin.	Pers.
	<ul style="list-style-type: none"> Nickel-plated brass Paracentral keyway 	4	0,005	50	1	01440	00	1		
	<ul style="list-style-type: none"> Nickel-plated brass Paracentral keyway 	3	0,003	50	1	01510	00	1		
	<ul style="list-style-type: none"> Nickel-plated brass Multiprofile Paracentral keyway 	5	0,010	50	1	01336	00	1		
	<ul style="list-style-type: none"> Nickel-plated brass Multiprofile Paracentral keyway 	4	0,009	50	1	01337	00	1		
	<ul style="list-style-type: none"> Nickel-plated brass Paracentral keyway 	5	0,015	50	1	00401	00	1		
Astral 	<ul style="list-style-type: none"> Nickel-plated brass Thickness 2.2 mm. Flat profile <p>TO BE DISCONTINUED</p>	10	0,015	50	1	00600	01	0		
Astral 	<ul style="list-style-type: none"> Nickel-plated brass Thickness 2.9 mm. Flat profile 	10	0,017	50	1	00620	01	0		

Type	Description	L	Pins	Unit weight 	Pieces 	ITEM				
						Type	Dim.	Hand	Fin.	Pers. Spec.

Astral

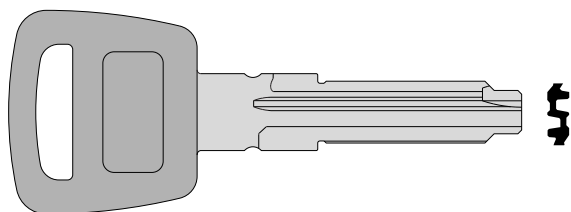

- Nickel-plated brass
- Nylon bow
- Long key
- Thickness 2.9 mm.
- Flat profile

10 0,015 20 1 00620 90 0

Asix

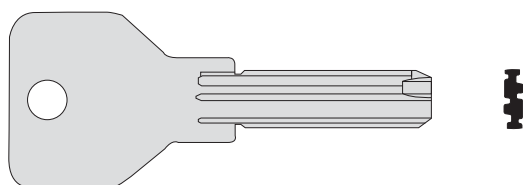

- Nickel-plated brass
- Thickness 2.9 mm.
- Flat profile

6 0,017 50 1 00670 01 0

AsixPRO

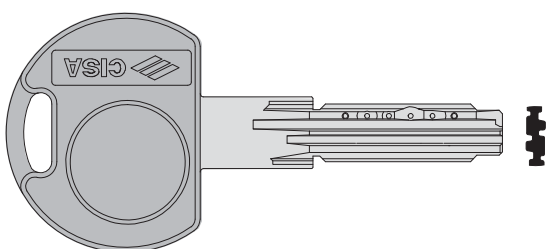

- Nickel-plated brass
- Thickness 2.9 mm.
- Flat profile

TO BE DISCONTINUED

10 0,015 50 1 00670 01 0 00 SD

AsixP8

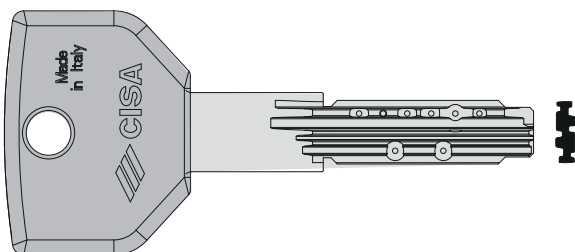

- Nickel-plated brass
- Nylon bow
- Long key 17 mm
- Flat profile, thickness 2.9 mm

8 0,027 50 1 00670 10 0

Type	Description	L	Pins	Unit weight	Pieces	ITEM				
						Type	Dim.	Hand	Fin.	Pers.

Astral Tekno PRO

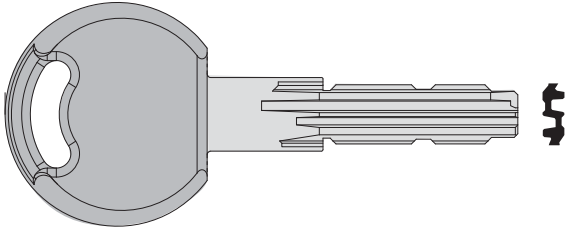

- Key protected by registered Community Design 001996109-0001
- Nickel-plated brass
- Nylon bow
- Long key 16 mm
- Flat profile, thickness 2.9 mm
- KEY BLANK DISTRIBUTION IS REGULATED BY CONTRACT

10 0,024 20 1 00690 00 0 00 CL

C3000 - C3000S

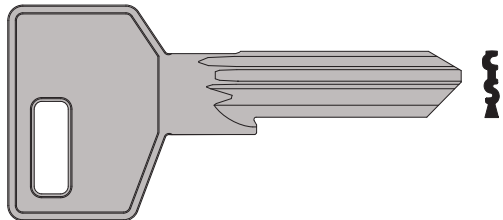

- Nickel silver alloy
- 3D Trade Mark
- Paracentral keyway
- KEYBLANK DISTRIBUTION IS REGULATED BY CONTRACT

6 0,015 50 1 00430 00 1

AP4 S

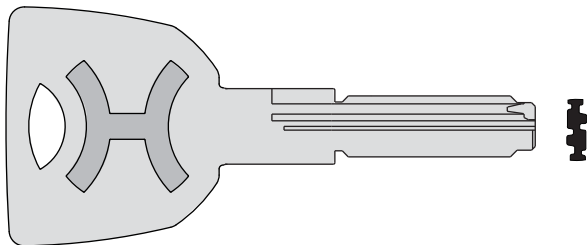





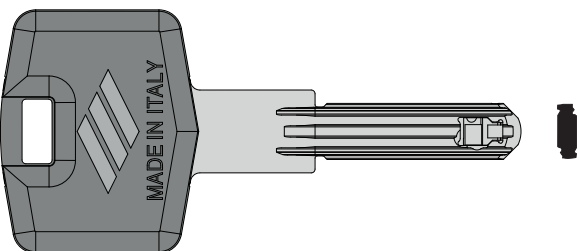



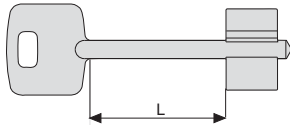

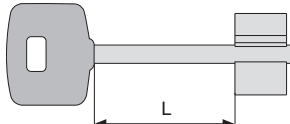

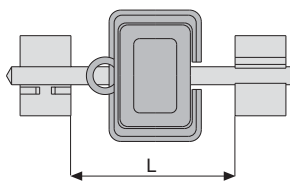

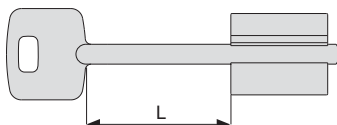
- SEE CISA SOLUTION PARTNER PROGRAM

RX

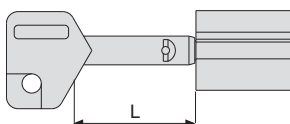

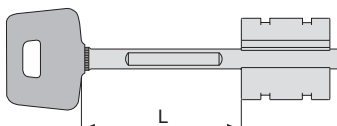
- SEE RED EXPERT PROGRAM

Type	Description	For locks series	L	Levers	Unit weight 	Pieces 	ITEM				
							Type	Dim.	Hand	Fin.	Pers. Spec.
		<ul style="list-style-type: none"> Nickel-plated brass 	17300, 57000, 57200, 57300, 57400, 57800	35,5	6	0,018	25	1	00100	00	1
				60,0	6	0,022	25	1	00102	00	1
	 	<ul style="list-style-type: none"> Nickel-plated brass Nylon bow 	57000, 57200, 57800	35,5	6	0,020	25	1	00101	00	1
				35,5	6	0,020	25	1	00101	00	2
				46,0		0,022	25	1	00104	00	1
		<ul style="list-style-type: none"> Nickel-plated brass Nylon bow 	57050, 57055, 57060	42,0	6	0,028	10	1	00110	00	1
	 	<ul style="list-style-type: none"> Nickel-plated brass 	17500, 57100, 57500	62,0	6	0,029	25	1	00120	00	1
				62,0	6	0,029	25	1	00120	00	2
				37,0	6	0,025	25	1	00121	00	1
		<ul style="list-style-type: none"> Nickel-plated brass Nylon bow 	17500, 56700, 57500, 57700	37,0	6	0,029	10	1	00122	00	1
				58,0	6	0,033	25	1	00123	00	1
				47,0	6	0,030	10	1	00124	00	1
	 	<ul style="list-style-type: none"> Nickel-plated brass 	57100, 57500	60,0	6	0,040	10	1	00125	00	1
				60,0	6	0,040	10	1	00125	00	2
		<ul style="list-style-type: none"> Nickel-plated brass Nylon bow 	17600, 57600, 57900	44,0	6	0,032	10	1	00162	00	1
				64,0	6	0,036	10	1	00163	00	1

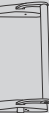

RS5 euro profile cylinders	59
RS5 rim cylinders.....	61
RS5 miscellaneous cylinder	62
RX euro profile cylinders	63
Components for modular cylinders	65
RX rim cylinders	67
RX miscellaneous cylinder	68
AP4 S european profile cylinders	69
AP4S - ASTRAL S - C3000 S Modulo cylinders	72
AP4 S Rim cylinders	77
AP4 S Various cylinders.....	79
ASTRAL Tekno Pro european profile cylinders.....	81
ASTRAL TEKNO rim cylinders	84
ASTRAL TEKNO various cylinders	86
Snap resistant Astral Cylinders	87
ASTRAL rim cylinders.....	89
ASTRAL various cylinders.....	91
ASIXP8 European profile cylinders	92

ASIXP8 PRO European profile cylinders.....	95
ASIXP8 rim cylinders	97
ASIXP8 various cylinders.....	98
ASIX European profile cylinders	99
ASIX rim cylinders	102
C3000 S European profile cylinders.....	104
C3000 European profile cylinders.....	107
C3000 rim cylinders	109
C3000 various cylinders	110
C2000 European profile cylinders.....	111
Hotel function cylinder C2000	114
Standard european profile cylinders C2000	115
C2000 rim cylinders	116
Standard rim cylinders	118
Standard various cylinders.....	119
Oval shaped cylinders	121
Accessories for cylinders	122
Dimensional drawings	126



Cylinders

RS5
RADIAL SYSTEM



The digital evolution of security

CISA is launching its new RS5 cylinder with **latest-generation radial technology** and **digital key duplication** which is always close at hand, giving you all the protection you need.

The patented cylinder with five rows of radial carbonitrided steel pins is the culmination for CISA of thirty years' experience developing maximum security cylinders.



cisa.com
allegion.com





Technical features:

Cylinder:

- Key biting system with 16 active pins arranged on 5 rows and double side control pin
- Module body in brass with zinc alloy extension bolts
- Carbonitrided steel pins
- Brass rotor
- Carbonitrided drivers
- Blocking and protective carbonitrided steel inserts
- Stainless steel springs
- Clutch-type DIN cam in self-lubricating sintered steel

Key:

- Flat reversible
- With patented mobile element
- Material: nickel silver alloy

- Ergonomic plastic key bow with innovative design
- Key blade 16 mm long, compatible with protective roses
- Numerical code on key bow

Supplied as standard:

- 3 keys
- SECURiCARD
- Fixing screws

Finishes:

- Standard: nickel-plated sanded brass (fin. 12)
- On request: polished brass (fin. 66), gunmetal grey (fin. 46)

Certifications:

- In compliance with EN 1303: 2015. - Attack resistance : D

- Key Related Security : 6
- Durability : 6
- For armoured doors classified 4 to 6 according to EN 1627

Certificates:

- ICIM EN 1303:15
- 16010C6D - Europe
- SKG***

Patents:

- key
 - radial system
 - mobile element
 - Registered shape trademark
- Cylinder
 - resistance to picking
 - resistance to bumping
 - modular system

Type	Description	Comm. dim.	Key item				Kg	Pieces	ITEM			
			L	A	B	Pins			Type	Dim.	Hand	Fin.

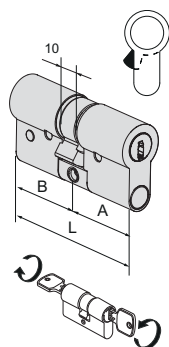

- Double cylinder with clutch system
- With RS5 modular technology, any size cylinder can be produced between 30-30 and 100-100 with 5 mm increments on each side

30 / 30	59,0	29,5	29,5	18	1 00820 00 0	0,240	1	1	OR3M1	07	0	12
30 / 35	64,0	29,5	34,5	18	1 00820 00 0	0,255	1	1	OR3M1	26	0	12
35 / 35	69,0	34,5	34,5	18	1 00820 00 0	0,270	1	1	OR3M1	13	0	12
40 / 30	69,0	39,5	29,5	18	1 00820 00 0	0,270	1	1	OR3M1	12	0	12
30 / 45	74,0	29,5	44,5	18	1 00820 00 0	0,285	1	1	OR3M1	27	0	12
35 / 40	74,0	34,5	39,5	18	1 00820 00 0	0,285	1	1	OR3M1	28	0	12
30 / 50	79,0	29,5	49,5	18	1 00820 00 0	0,300	1	1	OR3M1	17	0	12
35 / 45	79,0	34,5	44,5	18	1 00820 00 0	0,300	1	1	OR3M1	19	0	12
40 / 40	79,0	39,5	39,5	18	1 00820 00 0	0,300	1	1	OR3M1	18	0	12
30 / 55	84,0	29,5	54,5	18	1 00820 00 0	0,315	1	1	OR3M1	33	0	12
35 / 50	84,0	34,5	49,5	18	1 00820 00 0	0,315	1	1	OR3M1	31	0	12
40 / 45	84,0	39,5	44,5	18	1 00820 00 0	0,315	1	1	OR3M1	30	0	12
30 / 60	89,0	29,5	59,5	18	1 00820 00 0	0,330	1	1	OR3M1	20	0	12
35 / 55	89,0	34,5	54,5	18	1 00820 00 0	0,330	1	1	OR3M1	32	0	12
40 / 50	89,0	39,5	49,5	18	1 00820 00 0	0,330	1	1	OR3M1	21	0	12
45 / 45	89,0	44,5	44,5	18	1 00820 00 0	0,330	1	1	OR3M1	29	0	12
30 / 65	94,0	29,5	64,5	18	1 00820 00 0	0,345	1	1	OR3M1	41	0	12
35 / 60	94,0	34,5	59,5	18	1 00820 00 0	0,345	1	1	OR3M1	38	0	12
40 / 55	94,0	39,5	54,5	18	1 00820 00 0	0,345	1	1	OR3M1	42	0	12
45 / 50	94,0	44,5	49,5	18	1 00820 00 0	0,345	1	1	OR3M1	39	0	12
30 / 70	99,0	29,5	69,5	18	1 00820 00 0	0,360	1	1	OR3M1	24	0	12
35 / 65	99,0	34,5	64,5	18	1 00820 00 0	0,360	1	1	OR3M1	22	0	12
40 / 60	99,0	39,5	59,5	18	1 00820 00 0	0,360	1	1	OR3M1	25	0	12
45 / 55	99,0	44,5	54,5	18	1 00820 00 0	0,360	1	1	OR3M1	43	0	12
50 / 50	99,0	49,5	49,5	18	1 00820 00 0	0,360	1	1	OR3M1	23	0	12
40 / 65	104,0	39,5	64,5	18	1 00820 00 0	0,375	1	1	OR3M1	44	0	12
45 / 60	104,0	44,5	59,5	18	1 00820 00 0	0,375	1	1	OR3M1	54	0	12
30 / 75	104,0	29,5	74,5	18	1 00820 00 0	0,375	1	1	OR3M1	56	0	12
35 / 70	104,0	34,5	69,5	18	1 00820 00 0	0,375	1	1	OR3M1	49	0	12
55 / 50	104,0	54,5	49,5	18	1 00820 00 0	0,375	1	1	OR3M1	64	0	12
35 / 75	109,0	34,5	74,5	18	1 00820 00 0	0,390	1	1	OR3M1	57	0	12
30 / 80	109,0	29,5	79,5	18	1 00820 00 0	0,390	1	1	OR3M1	37	0	12
45 / 65	109,0	44,5	64,5	18	1 00820 00 0	0,390	1	1	OR3M1	45	0	12
40 / 70	109,0	39,5	69,5	18	1 00820 00 0	0,390	1	1	OR3M1	35	0	12
50 / 60	109,0	49,5	59,5	18	1 00820 00 0	0,390	1	1	OR3M1	36	0	12
55 / 55	109,0	54,5	54,5	18	1 00820 00 0	0,390	1	1	OR3M1	70	0	12
30 / 85	114,0	29,5	84,5	18	1 00820 00 0	0,405	1	1	OR3M1	77	0	12
50 / 65	114,0	49,5	64,5	18	1 00820 00 0	0,405	1	1	OR3M1	65	0	12
55 / 60	114,0	54,5	59,5	18	1 00820 00 0	0,405	1	1	OR3M1	71	0	12
40 / 75	114,0	39,5	74,5	18	1 00820 00 0	0,405	1	1	OR3M1	59	0	12
45 / 70	114,0	44,5	69,5	18	1 00820 00 0	0,405	1	1	OR3M1	61	0	12
30 / 90	119,0	29,5	89,5	18	1 00820 00 0	0,420	1	1	OR3M1	52	0	12
40 / 80	119,0	39,5	79,5	18	1 00820 00 0	0,420	1	1	OR3M1	60	0	12
60 / 60	119,0	59,5	59,5	18	1 00820 00 0	0,420	1	1	OR3M1	40	0	12
50 / 70	119,0	49,5	69,5	18	1 00820 00 0	0,420	1	1	OR3M1	66	0	12
50 / 80	129,0	49,5	79,5	18	1 00820 00 0	0,450	1	1	OR3M1	55	0	12
30 / 100	129,0	29,5	99,5	18	1 00820 00 0	0,450	1	1	OR3M1	53	0	12

Type	Description	Comm. dim.				Key item	Kg	Pieces	ITEM				
		L	A	B	Pins				Type	Dim.	Hand	Fin.	Pers.

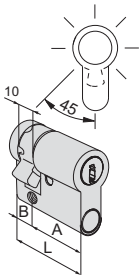

- Single cylinder with 8-position adjustable cam
- With RS5 modular technology, any size cylinder can be produced between 30-30 and 100-100 with 5 mm increments on each side

30 / 10	39,5	29,5	10,0	18	1 00820 00 0	0,180	1	1	OR3M4	02	0	12
35 / 10	44,5	34,5	10,0	18	1 00820 00 0	0,190	1	1	OR3M4	07	0	12
40 / 10	49,5	39,5	10,0	18	1 00820 00 0	0,200	1	1	OR3M4	03	0	12
45 / 10	54,5	44,5	10,0	18	1 00820 00 0	0,210	1	1	OR3M4	08	0	12
50 / 10	59,5	49,5	10,0	18	1 00820 00 0	0,220	1	1	OR3M4	04	0	12
55 / 10	64,5	54,5	10,0	18	1 00820 00 0	0,230	1	1	OR3M4	35	0	12
60 / 10	69,5	59,5	10,0	18	1 00820 00 0	0,240	1	1	OR3M4	05	0	12
65 / 10	74,5	64,5	10,0	18	1 00820 00 0	0,250	1	1	OR3M4	21	0	12
70 / 10	79,5	69,5	10,0	18	1 00820 00 0	0,260	1	1	OR3M4	06	0	12
80 / 10	89,5	79,5	10,0	18	1 00820 00 0	0,280	1	1	OR3M4	20	0	12

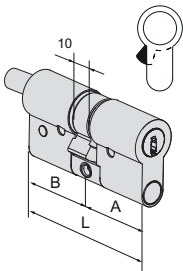

- Double cylinder pre-set for thumb turn installation
- With RS5 modular technology, any size cylinder can be produced between 30-30 and 100-100 with 5 mm increments on each side
- On request:
Thumb turns items 06353, 06355, 06356, 06357

30 / 30	59,0	29,5	29,5	18	1 00820 00 0	0,250	1	1	OR3M2	07	0	12
30 / 35	64,0	29,5	34,5	18	1 00820 00 0	0,260	1	1	OR3M2	26	0	12
35 / 30	64,0	34,5	29,5	18	1 00820 00 0	0,260	1	1	OR3M2	81	0	12
30 / 40	69,0	29,5	39,5	18	1 00820 00 0	0,270	1	1	OR3M2	82	0	12
40 / 30	69,0	39,5	29,5	18	1 00820 00 0	0,270	1	1	OR3M2	12	0	12
35 / 35	69,0	34,5	34,5	18	1 00820 00 0	0,270	1	1	OR3M2	13	0	12
30 / 45	74,0	29,5	44,5	18	1 00820 00 0	0,280	1	1	OR3M2	27	0	12
35 / 40	74,0	34,5	39,5	18	1 00820 00 0	0,280	1	1	OR3M2	28	0	12
40 / 35	74,0	39,5	34,5	18	1 00820 00 0	0,280	1	1	OR3M2	83	0	12
45 / 30	74,0	44,5	29,5	18	1 00820 00 0	0,280	1	1	OR3M2	91	0	12
30 / 50	79,0	29,5	49,5	18	1 00820 00 0	0,290	1	1	OR3M2	17	0	12
35 / 45	79,0	34,5	44,5	18	1 00820 00 0	0,290	1	1	OR3M2	19	0	12
40 / 40	79,0	39,5	39,5	18	1 00820 00 0	0,290	1	1	OR3M2	18	0	12
40 / 45	84,0	39,5	44,5	18	1 00820 00 0	0,300	1	1	OR3M2	30	0	12
30 / 60	89,0	29,5	59,5	18	1 00820 00 0	0,310	1	1	OR3M2	20	0	12
40 / 50	89,0	39,5	49,5	18	1 00820 00 0	0,310	1	1	OR3M2	21	0	12
45 / 45	89,0	44,5	44,5	18	1 00820 00 0	0,310	1	1	OR3M2	29	0	12
45 / 50	94,0	44,5	49,5	18	1 00820 00 0	0,320	1	1	OR3M2	39	0	12
40 / 60	99,0	39,5	59,5	18	1 00820 00 0	0,330	1	1	OR3M2	25	0	12
50 / 50	99,0	49,5	49,5	18	1 00820 00 0	0,330	1	1	OR3M2	23	0	12

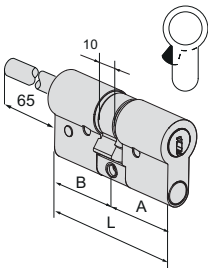

- Double cylinder pre-set for thumb turn installation, with adjustable shaft
- With RS5 modular technology, any size cylinder can be produced between 30-30 and 100-100 with 5 mm increments on each side
- For use with inside escutcheon item 1.06458.20
- On request:
Thumb turns items 06353, 06355, 06356, 06357

30 / 30	59,0	29,5	29,5	18	1 00820 00 0	0,260	1	1	OR3M7	07	0	12
35 / 30	64,0	34,5	29,5	18	1 00820 00 0	0,270	1	1	OR3M7	81	0	12
40 / 30	69,0	39,5	29,5	18	1 00820 00 0	0,280	1	1	OR3M7	12	0	12
45 / 30	74,0	44,5	29,5	18	1 00820 00 0	0,290	1	1	OR3M7	91	0	12
50 / 30	79,0	49,5	29,5	18	1 00820 00 0	0,300	1	1	OR3M7	90	0	12
55 / 30	84,0	54,5	29,5	18	1 00820 00 0	0,310	1	1	OR3M7	92	0	12
60 / 30	89,0	59,5	29,5	18	1 00820 00 0	0,320	1	1	OR3M7	87	0	12
65 / 30	94,0	64,5	29,5	18	1 00820 00 0	0,330	1	1	OR3M7	A3	0	12
70 / 30	99,0	69,5	29,5	18	1 00820 00 0	0,340	1	1	OR3M7	88	0	12
80 / 30	109,0	79,5	29,5	18	1 00820 00 0	0,360	1	1	OR3M7	93	0	12
90 / 30	119,0	89,5	29,5	18	1 00820 00 0	0,380	1	1	OR3M7	C6	0	12
100 / 30	129,0	99,5	29,5	18	1 00820 00 0	0,400	1	1	OR3M7	C7	0	12



Technical features:

Cylinder:

- Key biting system with 16 active pins arranged on 5 rows and double side control pin
- Module body in brass with zinc alloy extension bolts
- Carbonitrided steel pins
- Brass rotor
- Carbonitrided drivers
- Blocking and protective carbonitrided steel inserts
- Stainless steel springs

Key:

- Flat reversible
- With patented mobile element

- Material: nickel silver alloy
- Ergonomic plastic key bow with innovative design
- Key blade 16 mm long, compatible with protective roses
- Numerical code on key bow

Supplied as standard:

- 3 keys
- SECURICARD
- Fixing screws

Finishes:

- Standard: nickel-plated sanded brass (fin. 12)
- On request: polished brass (fin. 66)

Patents:

- **Key**
 - radial system
 - mobile element
 - shape trademark
- **Cylinder**
 - resistance to picking
 - resistance to bumping

RS5

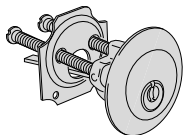
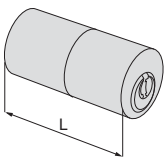
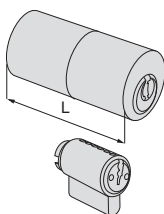
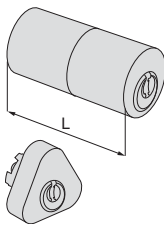
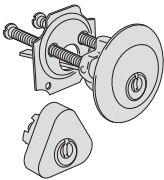

Type	Description	For locks series	Key item		Unit weight	Pieces	ITEM								
			L	Pins			Kg	Type	Dim.	Hand	Fin.	Pers.	Spec.		
	• Cylinder	1A610, 11610, 11615, 50110, 50130, 50180, 50330	18	1 00820 00 0	0,240	1	1	OR510	00	0	12				
	• Tubular cylinder	1A611, 11611, 50111, 50131, 50181, 50481	55,0	18	1 00820 00 0	0,215	1	1	OR210	55	0	12			
	• Pair of cylinders with external tubular cylinder	1A631, 1A721, 1A731	55,0	18	1 00820 00 0	0,295	1	1	OR150	00	0	12			
	• Pair of cylinders with external tubular cylinder	50121, 50161, 50171, 50421, 50461, 50471, 50521, 50561, 50571	55,0	18	1 00820 00 0	0,295	1	1	OR116	00	0	12			
		11631, 11731, 11931	55,0	18	1 00820 00 0	0,295	1	1	OR120	00	0	12			
		11721, 11921	55,0	18	1 00820 00 0	0,295	1	1	OR149	00	0	12			
	• Pair of cylinders	11670	18	1 00820 00 0	0,295	1	1	OR156	00	0	12				



RS5

Technical features:

Cylinder:

- Key biting system with 16 active pins arranged radially on 5 rows and double side control pin
- Module body in brass with zinc alloy extension bolts
- Carbonitrided steel pins
- Brass rotor
- Carbonitrided drivers
- Blocking and protective carbonitrided steel inserts
- Stainless steel springs

Key:

- Flat reversible
- With patented mobile element
- Material: nickel silver alloy
- Ergonomic plastic key bow with innovative design
- Key blade 16 mm long, compatible with protective roses
- Numerical code on key bow

Supplied as standard:

- 2 keys
- SECURICARD
- Fixing screws

Finishes:

- Nickel-plated sanded brass (fin. 12)

Patents:

key

- radial system
- mobile element
- shape trademark

Cylinder

- resistance to picking
- resistance to bumping

Type	Description	For locks series	L	Pins	Key item	Unit weight	Pieces	ITEM			
								Type	Dim.	Hand	Spec.

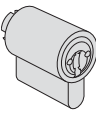
	<ul style="list-style-type: none"> • Steel padlock plug • 2 keys • Pickled brass body • Complete with plate 		18	1 00820 00 0	0,240	1	1	OR610 00 0			
---	---	--	----	--------------	-------	---	---	------------	--	--	--

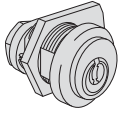
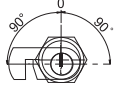
 	<ul style="list-style-type: none"> • Key extraction in position (0) • Ring • Deadbolt item 1.06414.25.0 or 1.06414.35.0 to be ordered separately • For doors with a max. thickness of 19 mm 		18	1 00820 00 0	0,150	1	1	OR410 00 0 12			
--	---	--	----	--------------	-------	---	---	---------------	--	--	--

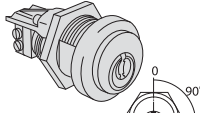
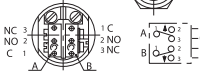
 	<ul style="list-style-type: none"> • Microswitch (7 A, 250 V) with welding terminals • Automatic return to key extraction position (0) • Ring • For doors with a max. thickness of 19 mm 		18	1 00820 00 0	0,150	1	1	OR415 01 0 12			
--	--	--	----	--------------	-------	---	---	---------------	--	--	--



EN 1303:15 KEY RELATED SECURITY 1 2 3 4 5 6

ATTACK RESISTANCE O A B C D

DURABILITY 1 2 3 4 5 6

RX



Technical features:

Cylinder:

- Key biting system with 16 active pins arranged radially on 5 rows and double side control pin
- Module body in brass with zinc alloy extension bolts
- Carbonitrided steel pins
- Brass rotor
- Carbonitrided drivers
- Blocking and protective carbonitrided steel inserts
- Stainless steel springs
- Clutch-type DIN cam in self-lubricating sintered steel

Key:

- Flat reversible
- With patented mobile element
- Material: nickel silver alloy

- Ergonomic plastic key bow with innovative design
- Key blade 16 mm long, compatible with protective roses
- Numerical code on key bow

Supplied as standard:

- 3 keys
- SECURiCARD
- Fixing screws

Finishes:

- Standard: nickel-plated sanded brass (fin. 12)
- On request: polished brass (fin. 66), gunmetal grey (fin. 46)

Certifications:

- In compliance with EN 1303: 2015.

- Attack resistance : D
- Key Related Security : 6
- Durability : 6
- For armoured doors classified 4 to 6 according to EN 1627

Certifications:

- ICIM EN 1303:15 16010C6D - Europe
- SKG***

Patents:

- Key -radial system
- mobile element
- shape trademark
- Cylinder
- resistance to picking
- resistance to bumping
- modular system

Type	Description	Comm. dim.	Key item				Kg	Pieces	ITEM				
			L	A	B	Pins			Type	Dim.	Hand	Fin.	Pars.

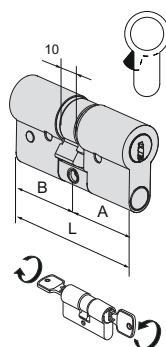

- Double cylinder with clutch system
- With RX5 modular technology, any size cylinder can be produced between 30-30 and 100-100 with 5 mm increments on each side

30 / 30	59,0	29,5	29,5	18	1 00830 00 0	0,240	1	1	OX3M1	07	0	12		
30 / 35	64,0	29,5	34,5	18	1 00830 00 0	0,255	1	1	OX3M1	26	0	12		
35 / 35	69,0	34,5	34,5	18	1 00830 00 0	0,270	1	1	OX3M1	13	0	12		
40 / 30	69,0	39,5	29,5	18	1 00830 00 0	0,270	1	1	OX3M1	12	0	12		
30 / 45	74,0	29,5	44,5	18	1 00830 00 0	0,285	1	1	OX3M1	27	0	12		
35 / 40	74,0	34,5	39,5	18	1 00830 00 0	0,285	1	1	OX3M1	28	0	12		
30 / 50	79,0	29,5	49,5	18	1 00830 00 0	0,300	1	1	OX3M1	17	0	12		
35 / 45	79,0	34,5	44,5	18	1 00830 00 0	0,300	1	1	OX3M1	19	0	12		
40 / 40	79,0	39,5	39,5	18	1 00830 00 0	0,300	1	1	OX3M1	18	0	12		
30 / 55	84,0	29,5	54,5	18	1 00830 00 0	0,315	1	1	OX3M1	33	0	12		
35 / 50	84,0	34,5	49,5	18	1 00830 00 0	0,315	1	1	OX3M1	31	0	12		
40 / 45	84,0	39,5	44,5	18	1 00830 00 0	0,315	1	1	OX3M1	30	0	12		
30 / 60	89,0	29,5	59,5	18	1 00830 00 0	0,330	1	1	OX3M1	20	0	12		
35 / 55	89,0	34,5	54,5	18	1 00830 00 0	0,330	1	1	OX3M1	32	0	12		
40 / 50	89,0	39,5	49,5	18	1 00830 00 0	0,330	1	1	OX3M1	21	0	12		
45 / 45	89,0	44,5	44,5	18	1 00830 00 0	0,330	1	1	OX3M1	29	0	12		
30 / 65	94,0	29,5	64,5	18	1 00830 00 0	0,345	1	1	OX3M1	41	0	12		
35 / 60	94,0	34,5	59,5	18	1 00830 00 0	0,345	1	1	OX3M1	38	0	12		
40 / 55	94,0	39,5	54,5	18	1 00830 00 0	0,345	1	1	OX3M1	42	0	12		
45 / 50	94,0	44,5	49,5	18	1 00830 00 0	0,345	1	1	OX3M1	39	0	12		
30 / 70	99,0	29,5	69,5	18	1 00830 00 0	0,360	1	1	OX3M1	24	0	12		
35 / 65	99,0	34,5	64,5	18	1 00830 00 0	0,360	1	1	OX3M1	22	0	12		
40 / 60	99,0	39,5	59,5	18	1 00830 00 0	0,360	1	1	OX3M1	25	0	12		
45 / 55	99,0	44,5	54,5	18	1 00830 00 0	0,360	1	1	OX3M1	43	0	12		
50 / 50	99,0	49,5	49,5	18	1 00830 00 0	0,360	1	1	OX3M1	23	0	12		
40 / 65	104,0	39,5	64,5	18	1 00830 00 0	0,375	1	1	OX3M1	44	0	12		
45 / 60	104,0	44,5	59,5	18	1 00830 00 0	0,375	1	1	OX3M1	54	0	12		
30 / 75	104,0	29,5	74,5	18	1 00830 00 0	0,375	1	1	OX3M1	56	0	12		
35 / 70	104,0	34,5	69,5	18	1 00830 00 0	0,375	1	1	OX3M1	49	0	12		
55 / 50	104,0	54,5	49,5	18	1 00830 00 0	0,375	1	1	OX3M1	64	0	12		
35 / 75	109,0	34,5	74,5	18	1 00830 00 0	0,390	1	1	OX3M1	57	0	12		
30 / 80	109,0	29,5	79,5	18	1 00830 00 0	0,390	1	1	OX3M1	37	0	12		
45 / 65	109,0	44,5	64,5	18	1 00830 00 0	0,390	1	1	OX3M1	45	0	12		
40 / 70	109,0	39,5	69,5	18	1 00830 00 0	0,390	1	1	OX3M1	35	0	12		
50 / 60	109,0	49,5	59,5	18	1 00830 00 0	0,390	1	1	OX3M1	36	0	12		
55 / 55	109,0	54,5	54,5	18	1 00830 00 0	0,390	1	1	OX3M1	70	0	12		
30 / 85	114,0	29,5	84,5	18	1 00830 00 0	0,405	1	1	OX3M1	77	0	12		
50 / 65	114,0	49,5	64,5	18	1 00830 00 0	0,405	1	1	OX3M1	65	0	12		
55 / 60	114,0	54,5	59,5	18	1 00830 00 0	0,405	1	1	OX3M1	71	0	12		
40 / 75	114,0	39,5	74,5	18	1 00830 00 0	0,405	1	1	OX3M1	59	0	12		
45 / 70	114,0	44,5	69,5	18	1 00830 00 0	0,405	1	1	OX3M1	61	0	12		
30 / 90	119,0	29,5	89,5	18	1 00830 00 0	0,420	1	1	OX3M1	52	0	12		
40 / 80	119,0	39,5	79,5	18	1 00830 00 0	0,420	1	1	OX3M1	60	0	12		
60 / 60	119,0	59,5	59,5	18	1 00830 00 0	0,420	1	1	OX3M1	40	0	12		
50 / 70	119,0	49,5	69,5	18	1 00830 00 0	0,420	1	1	OX3M1	66	0	12		
50 / 80	129,0	49,5	79,5	18	1 00830 00 0	0,450	1	1	OX3M1	55	0	12		
30 / 100	129,0	29,5	99,5	18	1 00830 00 0	0,450	1	1	OX3M1	53	0	12		

Type	Description	Comm. dim.				Key item	Kg	Pieces	ITEM				
		L	A	B	Pin				Type	Dim.	Hand	Fin.	Pers.

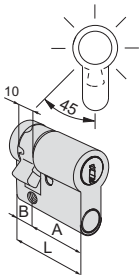

- Single cylinder with 8-position adjustable cam
- With RX5 modular technology, any size cylinder can be produced between 30-30 and 100-100 with 5 mm increments on each side

30 / 10	39,5	29,5	10,0	18	1 00830 00 0	0,180	1	1	OX3M4 02 0 12
35 / 10	44,5	34,5	10,0	18	1 00830 00 0	0,190	1	1	OX3M4 07 0 12
40 / 10	49,5	39,5	10,0	18	1 00830 00 0	0,200	1	1	OX3M4 03 0 12
45 / 10	54,5	44,5	10,0	18	1 00830 00 0	0,210	1	1	OX3M4 08 0 12
50 / 10	59,5	49,5	10,0	18	1 00830 00 0	0,220	1	1	OX3M4 04 0 12
55 / 10	64,5	54,5	10,0	18	1 00830 00 0	0,230	1	1	OX3M4 35 0 12
60 / 10	69,5	59,5	10,0	18	1 00830 00 0	0,240	1	1	OX3M4 05 0 12
65 / 10	74,5	64,5	10,0	18	1 00830 00 0	0,250	1	1	OX3M4 21 0 12
70 / 10	79,5	69,5	10,0	18	1 00830 00 0	0,260	1	1	OX3M4 06 0 12
80 / 10	89,5	79,5	10,0	18	1 00830 00 0	0,280	1	1	OX3M4 20 0 12

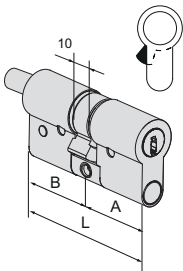

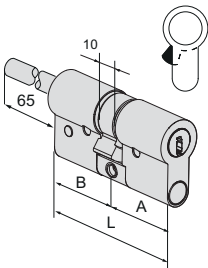

- Double cylinder pre-set for thumb turn installation
- With RX5 modular technology, any size cylinder can be produced between 30-30 and 100-100 with 5 mm increments on each side
- On request:
Thumb turns items 06353, 06355, 06356, 06357

30 / 30	59,0	29,5	29,5	18	1 00830 00 0	0,250	1	1	OX3M2 07 0 12
30 / 35	64,0	29,5	34,5	18	1 00830 00 0	0,260	1	1	OX3M2 26 0 12
35 / 30	64,0	34,5	29,5	18	1 00830 00 0	0,260	1	1	OX3M2 81 0 12
30 / 40	69,0	29,5	39,5	18	1 00830 00 0	0,270	1	1	OX3M2 82 0 12
35 / 35	69,0	34,5	34,5	18	1 00830 00 0	0,270	1	1	OX3M2 13 0 12
40 / 30	69,0	39,5	29,5	18	1 00830 00 0	0,270	1	1	OX3M2 12 0 12
30 / 45	74,0	29,5	44,5	18	1 00830 00 0	0,280	1	1	OX3M2 27 0 12
35 / 40	74,0	34,5	39,5	18	1 00830 00 0	0,280	1	1	OX3M2 28 0 12
40 / 35	74,0	39,5	34,5	18	1 00830 00 0	0,280	1	1	OX3M2 83 0 12
45 / 30	74,0	44,5	29,5	18	1 00830 00 0	0,280	1	1	OX3M2 91 0 12
30 / 50	79,0	29,5	49,5	18	1 00830 00 0	0,290	1	1	OX3M2 17 0 12
35 / 45	79,0	34,5	44,5	18	1 00830 00 0	0,290	1	1	OX3M2 19 0 12
40 / 40	79,0	39,5	39,5	18	1 00830 00 0	0,290	1	1	OX3M2 18 0 12
40 / 45	84,0	39,5	44,5	18	1 00830 00 0	0,300	1	1	OX3M2 30 0 12
30 / 60	89,0	29,5	59,5	18	1 00830 00 0	0,310	1	1	OX3M2 20 0 12
40 / 50	89,0	39,5	49,5	18	1 00830 00 0	0,310	1	1	OX3M2 21 0 12
45 / 45	89,0	44,5	44,5	18	1 00830 00 0	0,310	1	1	OX3M2 29 0 12
45 / 50	94,0	44,5	49,5	18	1 00830 00 0	0,320	1	1	OX3M2 39 0 12
40 / 60	99,0	39,5	59,5	18	1 00830 00 0	0,330	1	1	OX3M2 25 0 12
50 / 50	99,0	49,5	49,5	18	1 00830 00 0	0,330	1	1	OX3M2 23 0 12

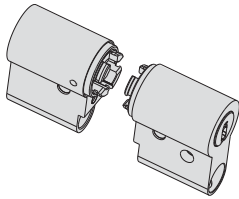
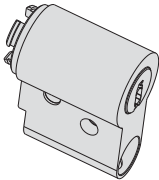
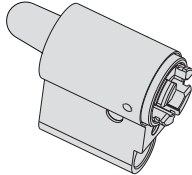
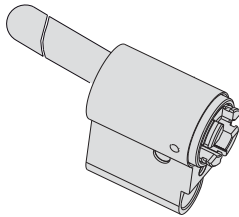
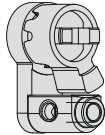

- Double cylinder pre-set for thumb turn installation, with adjustable shaft
- With RX5 modular technology, any size cylinder can be produced between 30-30 and 100-100 with 5 mm increments on each side
- For use with inside escutcheon item 1.06458.20
- On request:
Thumb turns items 06353, 06355, 06356, 06357

30 / 30	59,0	29,5	29,5	18	1 00830 00 0	0,260	1	1	OX3M7 07 0 12
35 / 30	64,0	34,5	29,5	18	1 00830 00 0	0,270	1	1	OX3M7 81 0 12
40 / 30	69,0	39,5	29,5	18	1 00830 00 0	0,280	1	1	OX3M7 12 0 12
45 / 30	74,0	44,5	29,5	18	1 00830 00 0	0,290	1	1	OX3M7 91 0 12
50 / 30	79,0	49,5	29,5	18	1 00830 00 0	0,300	1	1	OX3M7 90 0 12
55 / 30	84,0	54,5	29,5	18	1 00830 00 0	0,310	1	1	OX3M7 92 0 12
60 / 30	89,0	59,5	29,5	18	1 00830 00 0	0,320	1	1	OX3M7 87 0 12
65 / 30	94,0	64,5	29,5	18	1 00830 00 0	0,330	1	1	OX3M7 A3 0 12
70 / 30	99,0	69,5	29,5	18	1 00830 00 0	0,340	1	1	OX3M7 88 0 12
80 / 30	109,0	79,5	29,5	18	1 00830 00 0	0,360	1	1	OX3M7 93 0 12
90 / 30	119,0	89,5	29,5	18	1 00830 00 0	0,380	1	1	OX3M7 C6 0 12
100 / 30	129,0	99,5	29,5	18	1 00830 00 0	0,400	1	1	OX3M7 C7 0 12

Type	Description	Comm. dim.		Key item	Kg	Unit weight	Pieces	ITEM							
		L	Pins					Type	Dim.	Hand	Fin.	Pers.	Spec.		
	<ul style="list-style-type: none"> • RX pair of modules • 3 keys item 100830000 	30 / 30	18	1 00820 00 0	0,272	1	1	OX3M1	00	0	12				
	<ul style="list-style-type: none"> • RS5 pair of modules • 3 keys item 100820000 	30 / 30	59,0	18	1 00830 00 0	0,272	1	1	OR3M1	00	0	12			
	<ul style="list-style-type: none"> • RX single module • 3 keys item 100830000 	30		18	1 00820 00 0	0,272	1	1	OX3M4	00	0	12			
	<ul style="list-style-type: none"> • RS5 single module • 3 keys item 100820000 	30		18	1 00830 00 0	0,272	1	1	OR3M4	00	0	12			
	<ul style="list-style-type: none"> • Nickel-plated thumb turn module pack • Finishes on request: <ul style="list-style-type: none"> - Polished brass fin. 66 - Gunmetal grey fin. 46 	30				0,305	5	1	07580	56	0	12			
	<ul style="list-style-type: none"> • Nickel-plated adjustable thumb turn module pack • Finishes on request: <ul style="list-style-type: none"> - Polished brass fin. 66 - Gunmetal grey fin. 46 	30				0,305	5	1	07580	57	0	12			
	<ul style="list-style-type: none"> • Single cylinder kit pack <ul style="list-style-type: none"> - Connector - Support plate - Screw - Single cylinder follower - Pins and spring - Single cylinder terminal 					0,305	5	1	07580	71	0				
	<ul style="list-style-type: none"> • 35/10 single cylinder kit pack <ul style="list-style-type: none"> - Connector - Support plate - Screw - Single cylinder follower - Pins and spring - 35/10 single cylinder terminal 					0,305	2	1	07580	72	0				
	<ul style="list-style-type: none"> • Follower for clutch-type cylinder (for C3000S) 					0,305	100	1	07580	29	0				

Type	Description	Comm. dim.		Key item	Kg	Pieces	ITEM					
		L	Pin				Type	Dim.	Hand	Fin.	Pers.	Spec.
	• Coupling unit pack for double cylinder, with clutch system or with thumb turn shaft	X0 / X0			0,305	50	1	07580	34	0		
		X0 / X5			0,305	30	1	07580	36	0		
		X5 / X5			0,305	20	1	07580	37	0		
	• Extension kit pack for double cylinders, with clutch system, single cylinders or with thumb turn shaft	5			0,305	30	1	07580	75	0		
		10			0,305	25	1	07580	76	0		
		20			0,305	20	1	07580	77	0		
		30			0,305	10	1	07580	78	0		
	• Connector pack for double cylinders, with clutch system, single cylinders or with thumb turn shaft				0,305	50	1	07580	80	0		
	• Screw pack for double cylinders, with clutch system, single cylinders or with thumb turn shaft	30			0,305	50	1	07580	81	0		
		35			0,305	30	1	07580	82	0		
		40			0,305	30	1	07580	83	0		
		45			0,305	30	1	07580	84	0		
		50			0,305	30	1	07580	85	0		
		55			0,305	20*	1	07580	86	0		
		60			0,305	20*	1	07580	86	0		
		65			0,305	10*	1	07580	87	0		
		70			0,305	10*	1	07580	87	0		
		75			0,305	10*	1	07580	88	0		
		80			0,305	10*	1	07580	88	0		
		85			0,305	6*	1	07580	89	0		
		90			0,305	6*	1	07580	89	0		
		95			0,305	6*	1	07580	90	0		
		100			0,305	6*	1	07580	90	0		
		105			0,305	6*	1	07580	91	0		
110			0,305	6*	1	07580	91	0				
115			0,305	6*	1	07580	91	0				
120			0,305	6*	1	07580	91	0				
	(*) Quantity apportioned equally between the different sizes											
	• Key side block kit pack - Faceplate peg - Plug - Lateral peg - Screw locking pad				0,305	10	1	07580	63	0		
					0,305	10	1	07580	64	0		
	• Thumb turn side block kit pack - Plug - Plug peg				0,305	10	1	07580	64	0		



RX



Technical features:

Cylinder:

- Key biting system with 16 active pins arranged on 5 rows and double side control pin
- Module body in brass with zinc alloy extension bolts
- Carbonitrided steel pins
- Brass rotor
- Carbonitrided drivers
- Blocking and protective carbonitrided steel inserts
- Stainless steel springs

Key:

- Flat reversible
- With patented mobile element
- Material: nickel silver alloy

- Ergonomic plastic key bow with innovative design
- Key blade 16 mm long, compatible with protective roses
- Numerical code on key bow

Supplied as standard:

- 3 keys
- SECURICARD
- Fixing screws

Finishes:

- Standard: nickel-plated sanded brass (fin. 12)
- On request: polished brass (fin. 66)

Patents:

- **Key**
 - radial system
 - mobile element
 - shape trademark
- **Cylinder**
 - resistance to picking
 - resistance to bumping

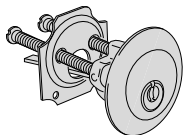
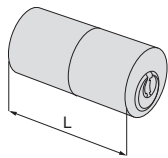
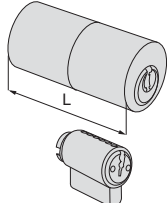
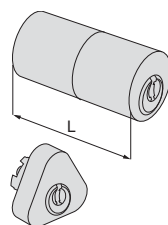
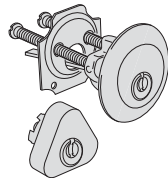
Type	Description	For locks series	Key item		Unit weight	Pieces	ITEM								
			L	Pins			Type	Dim.	Hand	Fin.	Pers.	Spec.			
	• Cylinder	1A610, 11610, 11615, 50110, 50130, 50180, 50330	18	1 00830 00 0	0,240	1	1	0X510	00	0	12				
	• Tubular cylinder	1A611, 11611, 50111, 50131, 50181, 50481	55,0	18	1 00830 00 0	0,215	1	1	0X210	55	0	12			
	• Pair of cylinders with external tubular cylinder	1A631, 1A721, 1A731	55,0	18	1 00830 00 0	0,295	1	1	0X150	00	0	12			
	• Pair of cylinders with external tubular cylinder	50121, 50161, 50171, 50421, 50461, 50471, 50521, 50561, 50571	55,0	18	1 00830 00 0	0,295	1	1	0X116	00	0	12			
		11631, 11731, 11931	55,0	18	1 00830 00 0	0,295	1	1	0X120	00	0	12			
		11721, 11921	55,0	18	1 00830 00 0	0,295	1	1	0X149	00	0	12			
	• Pair of cylinders	11670	18	1 00830 00 0	0,295	1	1	0X156	00	0	12				



Technical features:

Cylinder:

- Key biting system with 16 active pins arranged radially on 5 rows and double side control pin
- Module body in brass with zinc alloy extension bolts
- Carbonitrided steel pins
- Brass rotor
- Carbonitrided drivers
- Blocking and protective carbonitrided steel inserts
- Stainless steel springs

key:

- Flat reversible
- With patented mobile element
- Material: nickel silver alloy
- Ergonomic plastic key bow with innovative design
- Key blade 16 mm long, compatible with protective roses
- Numerical code on key bow

Supplied as standard:

- 2 keys
- SECURiCARD
- Fixing screw

Finishes:

- nickel-plated sanded brass (fin. 12)

Brevetti:

- **Key**
 - radial system
 - mobile element
 - shape trademark
- **Cylinder**
 - resistance to picking
 - resistance to bumping

RX



Type	Description	For locks series	L	Pins	Key item	Kg	Unit weight	Pieces	ITEM			
									Type	Dim.	Hand	Fin.

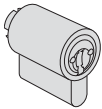

- Steel padlock plug
- 2 keys
- Pickled brass body
- Complete with plate

18 1 00830 00 0 0,240 1 1 0X610 00 0

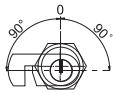
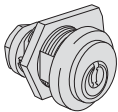

- Key extraction in position (0)
- Ring
- Deadbolt item 1.06414.25.0 or 1.06414.35.0 to be ordered separately
- For doors with a max. thickness of 19 mm

18 1 00830 00 0 0,150 1 1 0X410 00 0 12

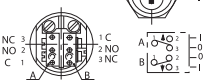
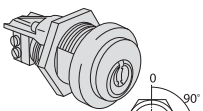

- Microswitch (7 A, 250 V) with welding terminals
- Automatic return to key extraction position (0)
- Ring
- For doors with a max. thickness of 19 mm

18 1 00830 00 0 0,150 1 1 0X415 01 0 12



EN 1303:15	KEY RELATED SECURITY	1	2	3	4	5	6
	ATTACK RESISTANCE	0	A	B	C	D	
	DURABILITY	1	2	3	4	5	6

Technical features:

- CYLINDER:
 - BKP resistance to pumping, patented system
 - Security Card: protected key duplication
 - Brass body with dual-material SNAP RESISTANT core
 - Brass plugs
 - Carbonitrided steel pins
 - Cylindrical and mushroom-like steel drivers with special anti-picking shape
 - Phosphor bronze and steel springs
 - Clutch-type DIN cam in self-lubricating sintered steel
- KEY:
 - flat reversible
 - in nickel silver alloy with mobile element
 - long neck, compatible with protective roses
 - numerical code on key bow

Supplied as standard:

- 3 keys
- Security Card
- Fixing screws
- Operating and maintenance instructions

Finishes:

- SUPPLIED AS STANDARD:
 - nickel-plated sanded brass (fin. 12)
- ON REQUEST:
 - polished brass (fin. 66)

Standards:

- In compliance with EN 1303:15
 - Attack Resistance: grade D
 - Key Related Security: grade 6
 - Durability: grade 6

Certificates:

- ICIM EN 1303:15
- 16010C6D - Europe
- SKG**

Patents:

- Key:
 - PCT/IT2013/000297-APA (Patent)
 - No. 1276648 (Trade Mark)
- BKP:
 - PCT/WO2007/074163A1
- Picking:
 - PCT/IT2016/000093

AP4 S

Type	Description	Comm. dim.	Key item				Kg	Pieces	ITEM			
			L	A	B	Pins			Type	Dim.	Hand	Fin.

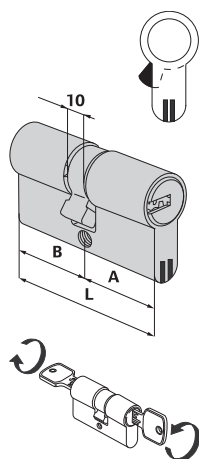

• Double cylinder with clutch system

30 / 30	59,0	29,5	29,5	12	1	00810 00 0	0,272	1	1	OP3S1	07	0	12
28 / 34	61,2	27,7	33,5	12	1	00810 00 0	0,272	1	1	OP3S1	06	0	12
30 / 33	64,0	29,5	34,5	12	1	00810 00 0	0,305	1	1	OP3S1	26	0	12
33 / 33	65,0	32,5	32,5	12	1	00810 00 0	0,272	1	1	OP3S1	10	0	12
35 / 35	69,0	34,5	34,5	12	1	00810 00 0	0,272	1	1	OP3S1	13	0	12
40 / 30	69,0	39,5	29,5	12	1	00810 00 0	0,272	1	1	OP3S1	12	0	12
30 / 45	74,0	29,5	44,5	12	1	00810 00 0	0,305	1	1	OP3S1	27	0	12
35 / 40	74,0	34,5	39,5	12	1	00810 00 0	0,305	1	1	OP3S1	28	0	12
30 / 50	79,0	29,5	49,5	12	1	00810 00 0	0,305	1	1	OP3S1	17	0	12
35 / 45	79,0	34,5	44,5	12	1	00810 00 0	0,305	1	1	OP3S1	19	0	12
40 / 40	79,0	39,5	39,5	12	1	00810 00 0	0,305	1	1	OP3S1	18	0	12
30 / 55	84,0	29,5	54,5	12	1	00810 00 0	0,305	1	1	OP3S1	33	0	12
35 / 50	84,0	34,5	49,5	12	1	00810 00 0	0,305	1	1	OP3S1	31	0	12
40 / 45	84,0	39,5	44,5	12	1	00810 00 0	0,305	1	1	OP3S1	30	0	12
30 / 60	89,0	29,5	59,5	12	1	00810 00 0	0,305	1	1	OP3S1	20	0	12
35 / 55	89,0	34,5	54,5	12	1	00810 00 0	0,305	1	1	OP3S1	32	0	12
40 / 50	89,0	39,5	49,5	12	1	00810 00 0	0,305	1	1	OP3S1	21	0	12
45 / 45	89,0	44,5	44,5	12	1	00810 00 0	0,305	1	1	OP3S1	29	0	12
30 / 65	94,0	29,5	64,5	12	1	00810 00 0	0,305	1	1	OP3S1	41	0	12
35 / 60	94,0	34,5	59,5	12	1	00810 00 0	0,305	1	1	OP3S1	38	0	12
40 / 55	94,0	39,5	54,5	12	1	00810 00 0	0,305	1	1	OP3S1	42	0	12
45 / 50	94,0	44,5	49,5	12	1	00810 00 0	0,305	1	1	OP3S1	39	0	12
30 / 70	99,0	29,5	69,5	12	1	00810 00 0	0,305	1	1	OP3S1	24	0	12
35 / 65	99,0	34,5	64,5	12	1	00810 00 0	0,305	1	1	OP3S1	22	0	12
40 / 60	99,0	39,5	59,5	12	1	00810 00 0	0,305	1	1	OP3S1	25	0	12
40 / 65	104,0	39,5	64,5	12	1	00810 00 0	0,305	1	1	OP3S1	44	0	12
45 / 55	99,0	44,5	54,5	12	1	00810 00 0	0,305	1	1	OP3S1	43	0	12
50 / 50	99,0	49,5	49,5	12	1	00810 00 0	0,305	1	1	OP3S1	23	0	12
30 / 75	104,0	29,5	74,5	12	1	00810 00 0	0,305	1	1	OP3S1	56	0	12
35 / 70	104,0	34,5	69,5	12	1	00810 00 0	0,305	1	1	OP3S1	49	0	12
45 / 60	104,0	44,5	59,5	12	1	00810 00 0	0,305	1	1	OP3S1	54	0	12
55 / 50	104,0	54,5	49,5	12	1	00810 00 0	0,305	1	1	OP3S1	64	0	12
30 / 80	109,0	29,5	79,5	12	1	00810 00 0	0,305	1	1	OP3S1	37	0	12
35 / 75	109,0	34,5	74,5	12	1	00810 00 0	0,305	1	1	OP3S1	57	0	12
40 / 70	109,0	39,5	69,5	12	1	00810 00 0	0,305	1	1	OP3S1	35	0	12
50 / 60	109,0	49,5	59,5	12	1	00810 00 0	0,390	1	1	OP3S1	36	0	12
55 / 55	109,0	54,5	54,5	12	1	00810 00 0	0,305	1	1	OP3S1	70	0	12
30 / 85	114,0	29,5	84,5	12	1	00810 00 0	0,305	1	1	OP3S1	77	0	12
40 / 75	114,0	39,5	74,5	12	1	00810 00 0	0,305	1	1	OP3S1	59	0	12
45 / 70	114,0	44,5	69,5	12	1	00810 00 0	0,305	1	1	OP3S1	61	0	12
50 / 65	114,0	49,5	64,5	12	1	00810 00 0	0,305	1	1	OP3S1	65	0	12
55 / 60	114,0	54,5	59,5	12	1	00810 00 0	0,305	1	1	OP3S1	71	0	12
30 / 90	119,0	29,5	89,5	12	1	00810 00 0	0,305	1	1	OP3S1	52	0	12
40 / 80	119,0	39,5	79,5	12	1	00810 00 0	0,305	1	1	OP3S1	60	0	12
50 / 70	119,0	49,5	69,5	12	1	00810 00 0	0,305	1	1	OP3S1	66	0	12
60 / 60	119,0	59,5	59,5	12	1	00810 00 0	0,305	1	1	OP3S1	40	0	12

Type	Description	Comm. dim.			Key item	Kg	Pieces	ITEM			
		L	A	B				Type	Dim.	Hand	Fin.

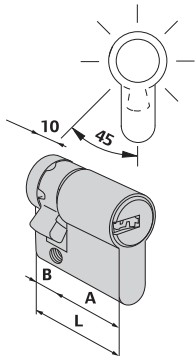

- Single cylinder with 8-position adjustable cam

30 / 10	39,5	29,5	10,0	12	1 00810 00 0	0,272	1	1	OP314	02	0	12
35 / 10	44,5	34,5	10,0	12	1 00810 00 0	0,272	1	1	OP314	07	0	12
40 / 10	49,5	39,5	10,0	12	1 00810 00 0	0,272	1	1	OP314	03	0	12
45 / 10	54,5	44,5	10,0	12	1 00810 00 0	0,272	1	1	OP314	08	0	12
50 / 10	59,5	49,5	10,0	12	1 00810 00 0	0,272	1	1	OP314	04	0	12
60 / 10	69,5	59,5	10,0	12	1 00810 00 0	0,272	1	1	OP314	05	0	12
65 / 10	74,5	64,5	10,0	12	1 00810 00 0	0,272	1	1	OP314	21	0	12
70 / 10	79,5	69,5	10,0	12	1 00810 00 0	0,272	1	1	OP314	06	0	12
80 / 10	89,5	79,5	10,0	12	1 00810 00 0	0,272	1	1	OP314	20	0	12
95 / 10	104,5	94,5	10,0	12	1 00810 00 0	0,272	1	1	OP314	13	0	12

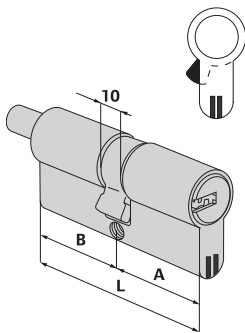

- Double cylinder pre-set for thumb turn installation
- ON REQUEST:
Thumb turns item 06353, 06355, 06356, 06357

30 / 30	59,0	29,5	29,5	12	1 00810 00 0	0,305	1	1	OP352	07	0	12
30 / 35	64,0	29,5	34,5	12	1 00810 00 0	0,305	1	1	OP352	26	0	12
35 / 30	64,0	34,5	29,5	12	1 00810 00 0	0,305	1	1	OP352	81	0	12
33 / 33	65,0	32,5	32,5	12	1 00810 00 0	0,305	1	1	OP352	10	0	12
30 / 40	69,0	29,5	39,5	12	1 00810 00 0	0,305	1	1	OP352	82	0	12
35 / 35	69,0	34,5	34,5	12	1 00810 00 0	0,305	1	1	OP352	13	0	12
40 / 30	69,0	39,5	29,5	12	1 00810 00 0	0,305	1	1	OP352	12	0	12
35 / 40	74,0	34,5	39,5	12	1 00810 00 0	0,305	1	1	OP352	28	0	12
30 / 45	74,0	29,5	44,5	12	1 00810 00 0	0,305	1	1	OP352	27	0	12
40 / 35	74,0	39,5	34,5	12	1 00810 00 0	0,305	1	1	OP352	83	0	12
45 / 30	74,0	44,5	29,5	12	1 00810 00 0	0,305	1	1	OP352	91	0	12
30 / 50	79,0	29,5	49,5	12	1 00810 00 0	0,305	1	1	OP352	17	0	12
35 / 45	79,0	34,5	44,5	12	1 00810 00 0	0,305	1	1	OP352	19	0	12
40 / 40	79,0	39,5	39,5	12	1 00810 00 0	0,305	1	1	OP352	18	0	12
45 / 35	79,0	44,5	34,5	12	1 00810 00 0	0,305	1	1	OP352	85	0	12
40 / 45	84,0	39,5	44,5	12	1 00810 00 0	0,305	1	1	OP352	30	0	12
45 / 40	84,0	44,5	39,5	12	1 00810 00 0	0,305	1	1	OP352	84	0	12
30 / 60	89,0	29,5	59,5	12	1 00810 00 0	0,305	1	1	OP352	20	0	12
40 / 50	89,0	39,5	49,5	12	1 00810 00 0	0,305	1	1	OP352	21	0	12
45 / 45	89,0	44,5	44,5	12	1 00810 00 0	0,305	1	1	OP352	29	0	12
40 / 55	94,0	39,5	54,5	12	1 00810 00 0	0,305	1	1	OP352	42	0	12
55 / 40	94,0	54,5	39,5	12	1 00810 00 0	0,305	1	1	OP352	98	0	12
45 / 50	94,0	44,5	49,5	12	1 00810 00 0	0,305	1	1	OP352	39	0	12
40 / 60	99,0	39,5	59,5	12	1 00810 00 0	0,305	1	1	OP352	25	0	12
45 / 55	99,0	44,5	54,5	12	1 00810 00 0	0,305	1	1	OP352	43	0	12
50 / 50	99,0	49,5	49,5	12	1 00810 00 0	0,305	1	1	OP352	23	0	12
40 / 65	104,0	39,5	64,5	12	1 00810 00 0	0,305	1	1	OP352	44	0	12
45 / 60	104,0	44,5	59,5	12	1 00810 00 0	0,305	1	1	OP352	54	0	12
55 / 50	104,0	54,5	49,5	12	1 00810 00 0	0,305	1	1	OP352	64	0	12
30 / 80	109,0	29,5	79,5	12	1 00810 00 0	0,305	1	1	OP352	37	0	12
35 / 75	109,0	34,5	74,5	12	1 00810 00 0	0,305	1	1	OP352	57	0	12
40 / 70	109,0	39,5	69,5	12	1 00810 00 0	0,305	1	1	OP352	35	0	12
50 / 60	109,0	49,5	59,5	12	1 00810 00 0	0,305	1	1	OP352	36	0	12
45 / 70	114,0	44,5	69,5	12	1 00810 00 0	0,305	1	1	OP352	61	0	12
50 / 65	114,0	49,5	64,5	12	1 00810 00 0	0,305	1	1	OP352	65	0	12

Type	Description	Comm. dim.				Key item	Kg	Pcs	ITEM			
		L	A	B	Pins				Type	Dim.	Hand	Fin.

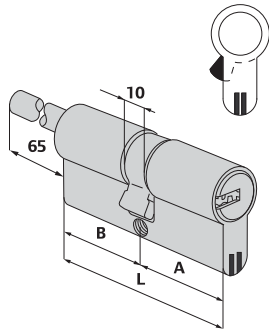

- Double cylinder with adjustable shaft, pre-set for thumb turn
- To use with inside escutcheon item 1.06458.20
- On request: Thumb turns item 06353, 06355, 06356, 06357

30 / 30	59,0	29,5	29,5	12	1	00810 00 0	0,272	1	1	OP3S7	07	0	12
35 / 30	64,0	34,5	29,5	12	1	00810 00 0	0,272	1	1	OP3S7	81	0	12
40 / 30	69,0	39,5	29,5	12	1	00810 00 0	0,272	1	1	OP3S7	12	0	12
45 / 30	74,0	44,5	29,5	12	1	00810 00 0	0,272	1	1	OP3S7	91	0	12
50 / 30	79,0	49,5	29,5	12	1	00810 00 0	0,272	1	1	OP3S7	90	0	12
55 / 30	84,0	54,5	29,5	12	1	00810 00 0	0,272	1	1	OP3S7	92	0	12
60 / 30	89,0	59,5	29,5	12	1	00810 00 0	0,272	1	1	OP3S7	87	0	12
65 / 30	94,0	64,5	29,5	12	1	00810 00 0	0,272	1	1	OP3S7	A3	0	12
70 / 30	99,0	69,5	29,5	12	1	00810 00 0	0,272	1	1	OP3S7	88	0	12
80 / 30	110,0	79,5	29,5	12	1	00810 00 0	0,272	1	1	OP3S7	93	0	12
90 / 30	120,0	89,5	29,5	12	1	00810 00 0	0,282	1	1	OP3S7	C6	0	12
100 / 30	130,0	99,5	29,5	12	1	00810 00 0	0,292	1	1	OP3S7	C7	0	12



Technical features:

- CISA patented system (AP4S - C3000S)
- Security Card: authorised key duplication by CISA or CISA Solution Partners (AP4S - C3000S)
- BKP resistance to pumping, patented system
- Brass body with dual-material SNAP RESISTANT core SIGILLO

Supplied as standard:

- 3 keys
- Fixing screws
- Operating and maintenance instructions



Finishes:

- SUPPLIED AS STANDARD:
Nickel-plated sanded brass (fin. 12)
- ON REQUEST:
Polished brass (fin. 66)

MODULO SYSTEM

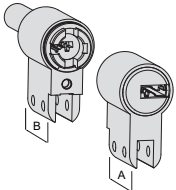
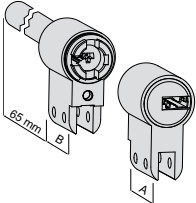
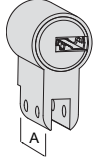
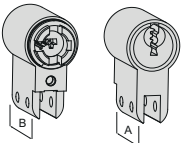
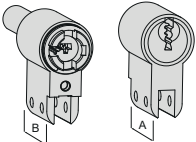
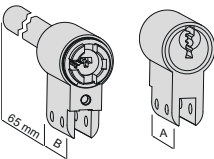
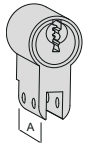
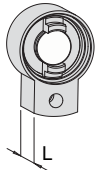
Type	Description	Comm. dim. A / B	L	Pins	Key item	Kg	Pieces	ITEM						
								Type	Dim.	Hand	Fin.	Pers.	Spec.	
	• Pair of modules for cylinder with clutch system AP4S	30 / 30	12	1	1 00810 00 0	0,272	1	1	OP3M1	07	0	12		
	• Pair of modules for cylinder with thumb turn shaft AP4S	30 / 30	12	1	1 00810 00 0	0,272	1	1	OP3M2	07	0	12		
	• Pair of modules for cylinder with adjustable thumb turn shaft AP4S	30 / 30	12	1	1 00810 00 0	0,272	1	1	OP3M7	07	0	12		
	• Module for single cylinder ASTRAL S	30	12	1	1 00810 00 0	0,272	1	1	OP3M4	02	0	12		
	• Pair of modules for cylinder with clutch system ASTRAL S	30 / 30	10	1	1 00620 90 0	0,272	1	1	OA3M1	07	0	12	CL	

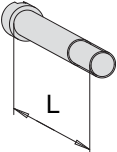
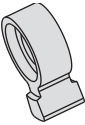
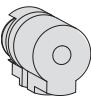
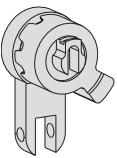
Type	Description	Comm. dim.		Key item	Kg	Pcs	ITEM							
		A	B				Type	Dim.	Hand	Fin.	Pers.	Spec.		
	• Pair of modules for cylinder with thumb turn shaft ASTRAL S	30	30	10	1	00620 90 0	0,272	1	1	0A3M2	07	0	12	CL
	• Pair of modules for cylinder with adjustable thumb turn shaft ASTRAL S	30	30	10	1	00620 90 0	0,272	1	1	0A3M7	07	0	12	CL
	• Module for single cylinder ASTRAL S	30		10	1	00620 90 0	0,272	1	1	0A3M4	02	0	12	CL
	• Pair of modules for cylinder with clutch system C3000S	30	30	6	1	00430 00 1	0,272	1	1	0N3M1	07	0	12	
	• Pair of modules for cylinder with thumb turn shaft C3000S	30	30	6	1	00430 00 1	0,272	1	1	0N3M2	07	0	12	
	• Pair of modules for cylinder with adjustable thumb turn shaft C3000S	30	30	6	1	00430 00 1	0,272	1	1	0N3M7	07	0	12	
	• Module for single cylinder C3000S	30		6	1	00430 00 1	0,272	1	1	0N3M4	02	0	12	
	• Extension bolt unit on key side for double cylinders and cylinders with thumb turn shaft (CISA patent)			5,0			0,305	30	1	07580	05	0		
				10,0			0,305	20	1	07580	01	0		
				20,0			0,305	20	1	07580	02	0		
				30,0			0,305	10	1	07580	03	0		

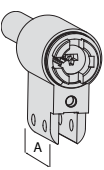
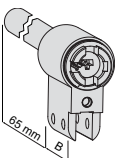
Type	Description	Comm. dim.		Key item	Kg	Pcs	ITEM						
		A	B				Type	Dim.	Hand	Fin.	Pers.	Spec.	
	<ul style="list-style-type: none"> Fixing screws for extension bolt unit 		5,0		0,305	50	1	07580	10	0			
			10,0		0,305	50	1	07580	11	A			
			15,0		0,305	50	1	07580	11	B			
			20,0		0,305	50	1	07580	12	A			
			25,0		0,305	50	1	07580	12	B			
			30,0		0,305	50	1	07580	13	A			
			35,0		0,305	50	1	07580	13	B			
			40,0		0,305	25	1	07580	14	A			
			45,0		0,305	25	1	07580	14	B			
			50,0		0,305	25	1	07580	15	A			
			55,0		0,305	25	1	07580	15	B			
			60,0		0,305	10	1	07580	16	A			
			65,0		0,305	10	1	07580	16	B			
			70,0		0,305	10	1	07580	17	A			
	<ul style="list-style-type: none"> Follower for clutch-type cylinder (for C3000S) Follower for clutch-type cylinder (for AP4S and ASTRAL S) 				0,305	100	1	07580	29	0			
					0,305	100	1	07580	30	0			
	<ul style="list-style-type: none"> Coupling unit for cylinder with clutch system (for C3000S) Coupling unit for cylinder with clutch system (for AP4S and ASTRAL S) 	30 / 30			0,305	50	1	07580	34	0			
		30 / 30		0,305	50	1	07580	31	0				
		30 / 35		0,305	50	1	07580	32	A				
		35 / 35		0,305	50	1	07580	33	A				
	<ul style="list-style-type: none"> Follower kit for single cylinder 				0,305	5	1	07580	60	A			
	<ul style="list-style-type: none"> Insert for fixing the "SNAP RESISTANT" system 				0,305	500	1	07580	20	0			
	<ul style="list-style-type: none"> Nickel-plated module for thumb turn cylinder (fin.12) On request: polished brass finish (fin. 66) 	30			0,305	5	1	07580	47	0	12		
	<ul style="list-style-type: none"> Nickel-plated module for thumb turn cylinder with adjustable shaft (fin.12) On request: polished brass finish (fin. 66) 	30			0,305	5	1	07580	48	0	12		

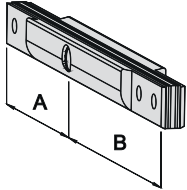
Type	Description	Comm. dim. A / B	L	Pins	Key item	Kg	Unit weight	Pieces	ITEM					
									Type	Dim.	Hand	Fin.	Pers.	Spec.
	<ul style="list-style-type: none"> • Pre-assembled SNAP RESISTANT system compatible with AP4 S, Astral S and C3000S 	30 / 30				0,305	5	1	07582	30	0			
		30 / 35				0,305	5	1	07582	31	0			
		30 / 40				0,305	5	1	07582	32	0			
		30 / 45				0,305	5	1	07582	33	0			
		30 / 50				0,305	5	1	07582	34	0			
		30 / 55				0,305	5	1	07582	35	0			
		30 / 60				0,305	2	1	07582	36	0			
		30 / 65				0,305	2	1	07582	37	0			
		30 / 70				0,305	2	1	07582	38	0			
		30 / 75				0,305	1	1	07582	39	0			
		30 / 80				0,305	1	1	07582	40	0			
		30 / 85				0,305	1	1	07582	41	0			
		30 / 90				0,305	1	1	07582	42	0			
		30 / 100				0,305	1	1	07582	44	0			
		35 / 35					0,305	5	1	07582	46	0		
		35 / 40					0,305	5	1	07582	47	0		
		35 / 45					0,305	5	1	07582	48	0		
		35 / 50					0,305	5	1	07582	49	0		
		35 / 55					0,305	2	1	07582	50	0		
		35 / 60					0,305	2	1	07582	51	0		
		35 / 65					0,305	2	1	07582	52	0		
		35 / 70					0,305	1	1	07582	53	0		
		35 / 75					0,305	1	1	07582	54	0		
		35 / 80					0,305	1	1	07582	55	0		
		40 / 40					0,305	5	1	07582	56	0		
		40 / 45					0,305	5	1	07582	57	0		
		40 / 50					0,305	2	1	07582	58	0		
		40 / 55					0,305	2	1	07582	59	0		
		40 / 60					0,305	2	1	07582	60	0		
		40 / 65					0,305	1	1	07582	61	0		
40 / 70					0,305	1	1	07582	62	0				
40 / 75					0,305	1	1	07582	63	0				
40 / 80					0,305	1	1	07582	64	0				
45 / 45					0,305	2	1	07582	66	0				
45 / 50					0,305	2	1	07582	67	0				
45 / 55					0,305	2	1	07582	68	0				
45 / 60					0,305	1	1	07582	69	0				
45 / 70					0,305	1	1	07582	71	0				
45 / 75					0,305	1	1	07582	72	0				
50 / 50					0,305	2	1	07582	76	0				
50 / 55					0,305	1	1	07582	77	0				
50 / 60					0,305	1	1	07582	78	0				
50 / 65					0,305	1	1	07582	79	0				
50 / 70					0,305	1	1	07582	80	0				
50 / 80					0,305	1	1	07582	82	0				
55 / 55					0,305	1	1	07582	86	0				
55 / 60					0,305	1	1	07582	87	0				
55 / 65					0,305	1	1	07582	88	0				
60 / 60					0,305	1	1	07582	95	0				

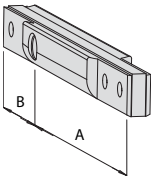
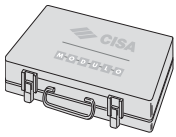
Type	Description	Comm. dim. A / B	L	Pins	Key item	Kg	Unit weight	Pieces	ITEM						
									Type	Dim.	Hand	Fin.	Pers.	Spec.	
	<ul style="list-style-type: none"> • Connector for single cylinder 	30 / 10				0,305	5	1	07582	10	0				
		35 / 10				0,305	5	1	07582	11	0				
		40 / 10				0,305	5	1	07582	12	0				
		45 / 10				0,305	5	1	07582	13	0				
		50 / 10				0,305	5	1	07582	14	0				
		55 / 10				0,305	2	1	07582	15	0				
		60 / 10				0,305	2	1	07582	16	0				
		65 / 10				0,305	2	1	07582	17	0				
		70 / 10				0,305	2	1	07582	18	0				
		80 / 10				0,305	2	1	07582	20	0				
		95 / 10				0,305	2	1	07582	23	0				
			<ul style="list-style-type: none"> • Assembly kit for Modulo System cylinders 					3,000	1	1	07550	14	0		



Technical features:

- CISA patented system:
key with mobile element
- Security Card: protected key duplication

CYLINDER:

- Brass body
- Brass plugs
- Carbonitrided steel pins
- Carbonitrided steel drivers
- Phosphor bronze springs

KEYS :

- flat reversible
- in nickel silver alloy with mobile element
- long neck, compatible with protective roses
- numerical code on key bow

Supplied as standard:

- 3 keys
- Security Card
- Fixing roses
- Fixing screws
- Operating and maintenance instructions

Finishes:

- **SUPPLIED AS STANDARD::**
- nickel-plated sanded brass (fin. 12)
- **ON REQUEST:**
- polished brass (fin. 66)

Patents:

- **Key:**
PCT/IT2013/000297-APA (Patent)
No. 1276648 (Trade Mark)

AP4 S

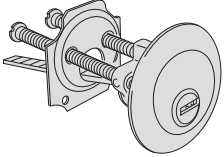
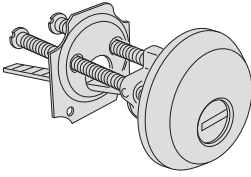
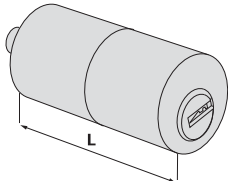
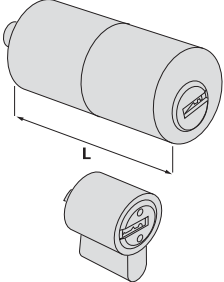
Type	Description	For locks series	Key item		Kg	Pieces	ITEM								
			L	Pins			Unit weight	Type	Dim.	Hand	Fin.	Pers.	Spec.		
	• Cylinder	1A610, 11610, 50110, 50130, 50180, 50330, 54310, 54315, 54340, 54510, 54550, 54570	12	1 00810 00 0	0,204	1	1	OP510	00	0	12				
	• Cylinder with nickel-plated anti-pulling and drill resistant protective rose		12	1 00810 00 0	0,325	1	1	OP510	10	0	12				
	• Tubular cylinder	1A611, 11611, 50111, 50131, 50181, 50411, 50481, 50511, 50581, 54316, 54341	50,0	12 1 00810 00 0	0,215	1	1	OP210	55	0	12				
	• Pair of cylinders with external tubular cylinder	1A631, 1A721, 1A731	50,0	12 1 00810 00 0	0,295	1	1	OP150	00	0	12				

Type	Description	For locks series	Key item				ITEM	
			L	Pins	Unit weight	Pieces	Type	Dim. Hand. Pers. Spec.

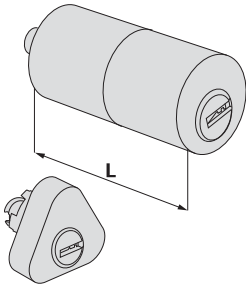

• Pair of cylinders with external tubular cylinder

50121, 50126, 50141,
50161, 50171, 50421,
50461, 50471, 50521,
50561, 50571

50,0 12 1 00810 00 0 0,295 1 1

OP116 00 0 12

11631, 11731, 11931

50,0 12 1 00810 00 0 0,295 1 1

OP120 00 0 12

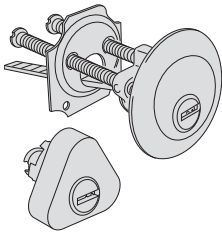

• Pair of cylinders

11670

12 1 00810 00 0 0,295 1 1

OP156 00 0 12

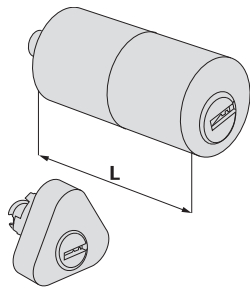

• Pair of cylinders with external tubular cylinder

11721, 11921

50,0 12 1 00810 00 0 0,295 1 1

OP149 00 0 12



Technical features:

- CISA patented system: **key with mobile element**
- Security Card: protected key duplication
- Brass body
- Brass plugs
- Carbonitrided steel pins
- Carbonitrided steel drivers
- Phosphor bronze springs
- Keys:
 - flat reversible
 - in nickel silver alloy with mobile element
 - long neck, compatible with protective roses
 - numerical code on key bow

Supplied as standard:

- 3 keys
- Security Card
- Fixing roses
- Fixing screws
- Operating and maintenance instructions

Finishes:

- Nickel-plated sanded brass (fin. 12)

Patents:

- Key:
 - PCT/IT2013/000297-APA (Patent)
 - N° 1276648 (Trade Mark)

AP4 S

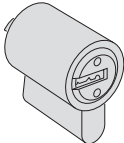
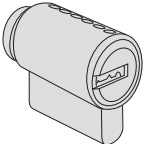
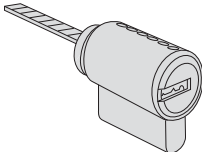
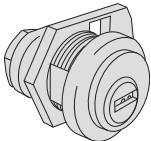
Type	Description	Door thickness Pins	Key item	Kg Unit weight	Pcs Pieces	ITEM				
						Type	Dim. Hand	Fin.	Pers. Spec.	
	<ul style="list-style-type: none"> • Steel padlock plug • 2 keys • Pickled brass body • Complete with plate item 1.07573.08.0 	12	1 00810 00 0	0,117	1	1	OP610	00	0	
	<ul style="list-style-type: none"> • Cylinder for outside access device 1.07078.28.0 	12	1 00810 00 0	0,117	1	1	OP610	10	0 12	
	<ul style="list-style-type: none"> • Cylinder for outside access device 1.07078.29.0 	12	1 00810 00 0	0,117	1	1	OP610	11	0 12	
	<ul style="list-style-type: none"> • Key extraction to position (0) • Ring item 1.06021.10.0 • Deadbolt item 1.06414.20.0 or 1.06414.30.0 (to be ordered separately) 	17	12 1 00810 00 0	0,117	1	1	OP410	00	0 12	

Type	Description	Door thickness Pins	Key item	Kg Unit weight	Box Pieces	ITEM			
						Type	Dim.	Hand	Fin.

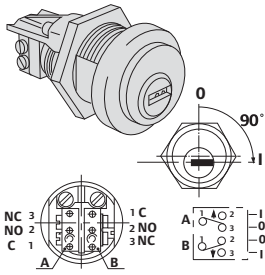

- Microswitch (7 A, 250 V) with welding terminals
- Automatic return to key extraction position (0)
- Ring item 1.06021.10.0

17 12 1 00810 00 0 0,117 1 1 OP415 01 0 12

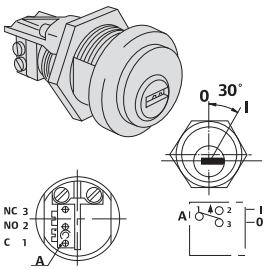

- Microswitch (7 A, 250 V) with welding terminals
- Automatic return to key extraction position (0)
- Ring item 1.06021.10.0

17 12 1 00810 00 0 0,117 1 1 OP415 03 0 12



EN 1303:15	KEY RELATED SECURITY	1	2	3	4	5	6
	ATTACK RESISTANCE	0	A	B	C	D	
	DURABILITY	1	2	3	4	5	6

Astral Tekno PRO

Technical features:

- CISA patented system
- BKP Resistance to bumping
- 10-pin key biting system
- Security Card: protected key duplication
- **Brass body with cut for controlled snapping**
- Brass plugs
- Clutch-type DIN cam in self-lubricating sintered steel
- Hardened steel pins
- Hardened steel drivers
- Double side control steel pin
- Phosphor bronze and steel springs
- Patented key:
 - flat reversible
 - in nickel-plated brass

- plastic key bow
- long neck, compatible with protective roses

Supplied as standard:

- 3 keys
- Security Card
- Fixing screw
- Operating and maintenance Instructions

Finishes:

- **SUPPLIED AS STANDARD:**
 - nickel-plated brass (fin. 12)
- **ON REQUEST:**
 - polished brass (fin. 66)



Standards:

- In compliance with 160B0C6C - EN 1303:15
- Attack Resistance: grade C
- Key Related Security: grade 6
- Durability: grade 6

Certificates:

- SKG**

Patents:

- Key: EP 1 867 810 B1
- Protected by registered Community Design 001996109-0001
- BKP: PCT/WO 2007/074163 A1

Type	Description	Comm. dim.	Key item	Kg	Pieces	ITEM			
						Type	Dim.	Hand	Fin.

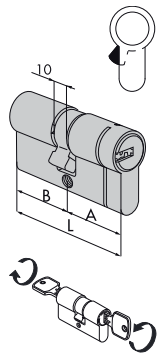

• Clutching system double cylinder

30 / 30	59,0	29,5	29,5	10	1 00690 00 0 00CL	0,235	1	1	OM3T1	07	0	12
28 / 34	61,2	27,7	33,5	10	1 00690 00 0 00CL	0,235	1	1	OM3T1	06	0	12
28 / 36	63,2	27,7	35,5	10	1 00690 00 0 00CL	0,243	1	1	OM3T1	09	0	12
30 / 35	64,0	29,5	34,5	10	1 00690 00 0 00CL	0,238	1	1	OM3T1	26	0	12
33 / 33	65,0	32,5	32,5	10	1 00690 00 0 00CL	0,258	1	1	OM3T1	10	0	12
35 / 35	69,0	34,5	34,5	10	1 00690 00 0 00CL	0,272	1	1	OM3T1	13	0	12
40 / 30	69,0	39,5	29,5	10	1 00690 00 0 00CL	0,272	1	1	OM3T1	12	0	12
28 / 43	70,2	27,7	42,5	10	1 00690 00 0 00CL	0,272	1	1	OM3T1	11	0	12
30 / 45	74,0	29,5	44,5	10	1 00690 00 0 00CL	0,274	1	1	OM3T1	27	0	12
35 / 40	74,0	34,5	39,5	10	1 00690 00 0 00CL	0,274	1	1	OM3T1	28	0	12
30 / 50	79,0	29,5	49,5	10	1 00690 00 0 00CL	0,290	1	1	OM3T1	17	0	12
35 / 45	79,0	34,5	44,5	10	1 00690 00 0 00CL	0,290	1	1	OM3T1	19	0	12
40 / 40	79,0	39,5	39,5	10	1 00690 00 0 00CL	0,290	1	1	OM3T1	18	0	12
30 / 55	84,0	29,5	54,5	10	1 00690 00 0 00CL	0,304	1	1	OM3T1	33	0	12
35 / 50	84,0	34,5	49,5	10	1 00690 00 0 00CL	0,304	1	1	OM3T1	31	0	12
40 / 45	84,0	39,5	44,5	10	1 00690 00 0 00CL	0,304	1	1	OM3T1	30	0	12
30 / 60	89,0	29,5	59,5	10	1 00690 00 0 00CL	0,320	1	1	OM3T1	20	0	12
35 / 55	89,0	34,5	54,5	10	1 00690 00 0 00CL	0,320	1	1	OM3T1	32	0	12
40 / 50	89,0	39,5	49,5	10	1 00690 00 0 00CL	0,320	1	1	OM3T1	21	0	12
45 / 45	89,0	44,5	44,5	10	1 00690 00 0 00CL	0,320	1	1	OM3T1	29	0	12
30 / 65	94,0	29,5	64,5	10	1 00690 00 0 00CL	0,330	1	1	OM3T1	41	0	12
35 / 60	94,0	34,5	59,5	10	1 00690 00 0 00CL	0,330	1	1	OM3T1	38	0	12
40 / 55	94,0	39,5	54,5	10	1 00690 00 0 00CL	0,330	1	1	OM3T1	42	0	12
45 / 50	94,0	44,5	49,5	10	1 00690 00 0 00CL	0,330	1	1	OM3T1	39	0	12
30 / 70	99,0	29,5	69,5	10	1 00690 00 0 00CL	0,340	1	1	OM3T1	24	0	12
35 / 65	99,0	34,5	64,5	10	1 00690 00 0 00CL	0,350	1	1	OM3T1	22	0	12
40 / 60	99,0	39,5	59,5	10	1 00690 00 0 00CL	0,350	1	1	OM3T1	25	0	12
45 / 55	99,0	44,5	54,5	10	1 00690 00 0 00CL	0,340	1	1	OM3T1	43	0	12
50 / 50	99,0	49,5	49,5	10	1 00690 00 0 00CL	0,340	1	1	OM3T1	23	0	12
40 / 65	104,0	39,5	64,5	10	1 00690 00 0 00CL	0,365	1	1	OM3T1	44	0	12
45 / 60	104,0	44,5	59,5	10	1 00690 00 0 00CL	0,365	1	1	OM3T1	54	0	12
30 / 75	104,0	29,5	74,5	10	1 00690 00 0 00CL	0,365	1	1	OM3T1	56	0	12
35 / 70	104,0	34,5	69,5	10	1 00690 00 0 00CL	0,365	1	1	OM3T1	49	0	12
55 / 50	104,0	54,5	49,5	10	1 00690 00 0 00CL	0,365	1	1	OM3T1	64	0	12
35 / 75	109,0	34,5	74,5	10	1 00690 00 0 00CL	0,360	1	1	OM3T1	57	0	12
30 / 80	109,0	29,5	79,5	10	1 00690 00 0 00CL	0,360	1	1	OM3T1	37	0	12
45 / 65	109,0	44,5	64,5	10	1 00690 00 0 00CL	0,360	1	1	OM3T1	45	0	12

Type	Description	Comm. dim.			Key item	Kg	Pieces	ITEM				
		L	A	B				Pin	Type	Dim.	Hand	Fin.

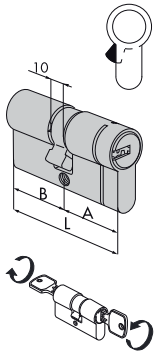

• Clutching system double cylinder

40 / 70	109,0	39,5	69,5	10	1 00690 00 0 00CL	0,360	1	1	OM3T1	35	0	12
50 / 60	109,0	49,5	59,5	10	1 00690 00 0 00CL	0,360	1	1	OM3T1	36	0	12
55 / 55	109,0	54,5	54,5	10	1 00690 00 0 00CL	0,360	1	1	OM3T1	70	0	12
30 / 85	114,0	29,5	84,5	10	1 00690 00 0 00CL	0,400	1	1	OM3T1	77	0	12
50 / 65	114,0	49,5	64,5	10	1 00690 00 0 00CL	0,400	1	1	OM3T1	65	0	12
55 / 60	114,0	54,5	59,5	10	1 00690 00 0 00CL	0,400	1	1	OM3T1	71	0	12
40 / 75	114,0	39,5	74,5	10	1 00690 00 0 00CL	0,400	1	1	OM3T1	59	0	12
45 / 70	114,0	44,5	69,5	10	1 00690 00 0 00CL	0,400	1	1	OM3T1	61	0	12
30 / 90	119,0	29,5	89,5	10	1 00690 00 0 00CL	0,420	1	1	OM3T1	52	0	12
40 / 80	119,0	39,5	79,5	10	1 00690 00 0 00CL	0,420	1	1	OM3T1	60	0	12
60 / 60	119,0	59,5	59,5	10	1 00690 00 0 00CL	0,420	1	1	OM3T1	40	0	12
50 / 70	119,0	49,5	69,5	10	1 00690 00 0 00CL	0,420	1	1	OM3T1	66	0	12
30 / 100	129,0	29,5	99,5	10	1 00690 00 0 00CL	0,460	1	1	OM3T1	53	0	12

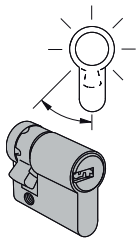

• Single cylinder with adjustable cam in 8 position

30 / 10	39,5	29,5	10,0	10	1 00690 00 0 00CL	0,185	1	1	OM324	02	0	12
35 / 10	44,5	34,5	10,0	10	1 00690 00 0 00CL	0,195	1	1	OM324	07	0	12
40 / 10	49,5	39,5	10,0	10	1 00690 00 0 00CL	0,205	1	1	OM324	03	0	12
45 / 10	54,5	44,5	10,0	10	1 00690 00 0 00CL	0,215	1	1	OM324	08	0	12
50 / 10	59,5	49,5	10,0	10	1 00690 00 0 00CL	0,225	1	1	OM324	04	0	12
55 / 10	64,5	49,5	10,0	10	1 00690 00 0 00CL	0,225	1	1	OM324	35	0	12
60 / 10	69,5	59,5	10,0	10	1 00690 00 0 00CL	0,245	1	1	OM324	05	0	12
65 / 10	74,5	64,5	10,0	10	1 00690 00 0 00CL	0,255	1	1	OM324	21	0	12
70 / 10	79,5	69,5	10,0	10	1 00690 00 0 00CL	0,265	1	1	OM324	06	0	12
80 / 10	89,5	79,5	10,0	10	1 00690 00 0 00CL	0,285	1	1	OM324	20	0	12
95 / 10	104,5	94,5	10,0	10	1 00690 00 0 00CL	0,315	1	1	OM324	13	0	12

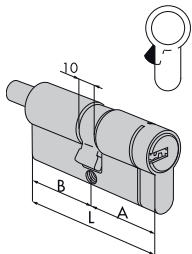

• Double cylinder with thumb turn shaft
 • ON REQUEST:
 Knobs series
 06353, 06355, 06356, 06357

30 / 30	59,0	29,5	29,5	10	1 00690 00 0 00CL	0,240	1	1	OM3T2	07	0	12
30 / 35	64,0	29,5	34,5	10	1 00690 00 0 00CL	0,250	1	1	OM3T2	26	0	12
35 / 30	64,0	34,5	29,5	10	1 00690 00 0 00CL	0,250	1	1	OM3T2	81	0	12
30 / 40	69,0	29,5	39,5	10	1 00690 00 0 00CL	0,260	1	1	OM3T2	82	0	12
35 / 35	69,0	34,5	34,5	10	1 00690 00 0 00CL	0,260	1	1	OM3T2	13	0	12
40 / 30	69,0	39,5	29,5	10	1 00690 00 0 00CL	0,260	1	1	OM3T2	12	0	12
35 / 40	74,0	34,5	39,5	10	1 00690 00 0 00CL	0,270	1	1	OM3T2	28	0	12
30 / 45	74,0	29,5	44,5	10	1 00690 00 0 00CL	0,270	1	1	OM3T2	27	0	12
40 / 35	74,0	39,5	34,5	10	1 00690 00 0 00CL	0,270	1	1	OM3T2	83	0	12
45 / 30	74,0	44,5	29,5	10	1 00690 00 0 00CL	0,270	1	1	OM3T2	91	0	12
30 / 50	79,0	29,5	49,5	10	1 00690 00 0 00CL	0,280	1	1	OM3T2	17	0	12
35 / 45	79,0	34,5	44,5	10	1 00690 00 0 00CL	0,280	1	1	OM3T2	19	0	12
40 / 40	79,0	39,5	39,5	10	1 00690 00 0 00CL	0,280	1	1	OM3T2	18	0	12
40 / 45	84,0	39,5	44,5	10	1 00690 00 0 00CL	0,290	1	1	OM3T2	30	0	12
30 / 60	89,0	29,5	59,5	10	1 00690 00 0 00CL	0,300	1	1	OM3T2	20	0	12
40 / 50	89,0	39,5	49,5	10	1 00690 00 0 00CL	0,300	1	1	OM3T2	21	0	12
45 / 45	89,0	44,5	44,5	10	1 00690 00 0 00CL	0,300	1	1	OM3T2	29	0	12
45 / 50	94,0	44,5	49,5	10	1 00690 00 0 00CL	0,300	1	1	OM3T2	39	0	12
40 / 60	99,0	39,5	59,5	10	1 00690 00 0 00CL	0,320	1	1	OM3T2	25	0	12
50 / 50	99,0	49,5	49,5	10	1 00690 00 0 00CL	0,320	1	1	OM3T2	23	0	12

Type	Description	Comm. dim.				Key item	Kg	Pcs	ITEM			
		L	A	B	pins				Type	Dim.	Hand	Fin.

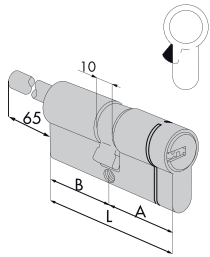

- Double cylinder with adjustable thumb turn shaft
- To be combined with inside rose item 1.06458.20
- ON REQUEST:
Knobs series
06353, 06355,
06356, 06357

30 / 30	59,0	29,5	29,5	10	1 00690 00 0 00CL	0,284	1	1	OM3T7 07 0 12
35 / 30	64,0	34,5	29,5	10	1 00690 00 0 00CL	0,294	1	1	OM3T7 81 0 12
40 / 30	69,0	39,5	29,5	10	1 00690 00 0 00CL	0,304	1	1	OM3T7 12 0 12
45 / 30	74,0	44,5	29,5	10	1 00690 00 0 00CL	0,314	1	1	OM3T7 91 0 12
50 / 30	79,0	49,5	29,5	10	1 00690 00 0 00CL	0,324	1	1	OM3T7 90 0 12
55 / 30	84,0	54,5	29,5	10	1 00690 00 0 00CL	0,334	1	1	OM3T7 92 0 12
60 / 30	89,0	59,5	29,5	10	1 00690 00 0 00CL	0,344	1	1	OM3T7 87 0 12
65 / 30	94,0	64,5	29,5	10	1 00690 00 0 00CL	0,354	1	1	OM3T7 A3 0 12
70 / 30	99,0	69,5	29,5	10	1 00690 00 0 00CL	0,364	1	1	OM3T7 88 0 12
80 / 30	109,0	79,5	29,5	10	1 00690 00 0 00CL	0,384	1	1	OM3T7 93 0 12
90 / 30	119,0	89,5	29,5	10	1 00690 00 0 00CL	0,404	1	1	OM3T7 C6 0 12
100 / 30	129,0	99,5	29,5	10	1 00690 00 0 00CL	0,424	1	1	OM3T7 C7 0 12



Technical features:

- Cisa patented system
- 10 pin (6 active, 4 passive) key biting system
- Security Card: protected key duplication
- Brass body
- Brass plugs
- Self-lubricating DIN sintered steel clutch-type cam
- Casehardened steel pins
- Hardened steel pin drivers
- Double side control steel pin
- Phosphorous bronze and steel springs
- Patented key:
 - reversible flat key
 - nickel-plated brass key
 - plastic material head
 - long neck, compatible with protective roses

Supplied as standard:

- 3 keys
- Security Card
- Fixing screw
- Fixing roses
- Operating and maintenance Instructions

Finishes:

- STANDARD:
 - nickel-plated brass (fin. 12)
- ON REQUEST:
 - polished brass (fin. 66)

Patents:

- Key: EP 1 867 810 B1
- Protected by registered Community Design 001996109-0001

Astral Tekno PRO

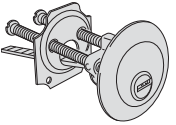
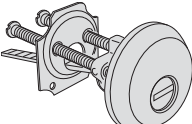
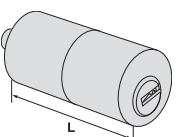
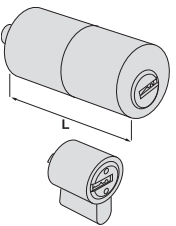
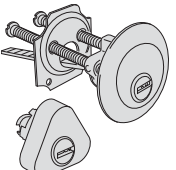
Type	Description	For locks series	L	Pins	Key item	Kg	Pieces	ITEM					
								Type	Dim.	Hand	Fin.	Pers.	Spec.
	• Rim cylinder	1A610, 11610, 50110, 50130, 50180, 50330, 54310, 54315, 54340, 54510, 54550, 54570	10	10	1 00690 00 0 00CL	0,204	1	1	0M510	00	0	12	CL
	• Rim cylinder with plated tear and drill resistant rose		10	10	1 00690 00 0 00CL	0,325	1	1	0M510	10	0	12	CL
	• Round cylinder • For further length see item 07165	1A611, 11611, 50111, 50131, 50181, 50411, 50481, 50511, 50581, 54316, 54341	50,0	10	1 00690 00 0 00CL	0,160	1	1	0M210	50	0	12	CL
	• Cylinder set, with round external cylinder	1A631, 1A721, 1A731	55,0	10	1 00690 00 0 00CL	0,267	1	1	0M150	00	0	12	CL
	• Cylinder set	50120, 50125, 50160, 50170, 50210, 50220	10	10	1 00690 00 0 00CL	0,267	1	1	0M112	00	0	12	CL
		11630	10	10	1 00690 00 0 00CL	0,267	1	1	0M114	00	0	12	CL

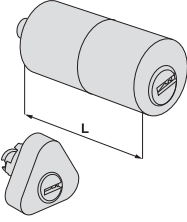
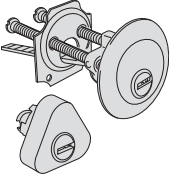
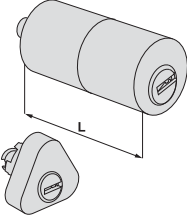
Type	Description	For locks series	Key item		Unit weight	Pieces	ITEM					
			L	Plms			kg	Type	Dim.	Hand	Fin.	Pers.
	• Cylinder set, with round external cylinder	50121, 50126, 50141, 50161, 50171, 50211, 50221, 50421, 50461, 50471, 50521, 50561, 50571	10	1 00690 00 0 00CL	0,267	1	1	OM116	00	0	12	CL
		11631, 11731, 11931	10	1 00690 00 0 00CL	0,267	1	1	OM120	00	0	12	CL
	• Cylinder set, with round external cylinder	11670	10	1 00690 00 0 00CL	0,267	1	1	OM156	00	0	12	CL
	• Cylinder set, with round external cylinder	11721, 11921	50,0	10 1 00690 00 0 00CL	0,267	1	1	OM149	00	0	12	CL
		11671, 11761, 11771	50,0	10 1 00690 00 0 00CL	0,267	1	1	OM155	00	0	12	CL



Technical features:

- BKP Cisa patented system
- 10 pin (6 active, 4 passive) key biting system
- Security Card: protected key duplication
- Brass casing
- Brass plugs
- Self-lubricating DIN sintered steel clutch-type cam
- Casehardened steel pins
- Hardened steel pin drivers
- Double side control steel pin
- Phosphorous bronze and steel springs
- Patented key:
 - reversible flat key
 - nickel-plated brass key
 - plastic material head
 - long neck, compatible with protective roses

Supplied as standard:

- 3 keys
- Security Card
- Fixing screw
- Fixing roses
- Operating and maintenance Instructions

Finishes:

- STANDARD:
 - nickel-plated brass (fin. 12)

Patents:

Key: EP 1 867 810 B1
 Protected by registered
 Community Design 001996109-0001

Astral Tekno PRO

Type	Description	Door thickness	Pins	Key item	Unit weight	Pieces	ITEM				
							Type	Dim.	Hand	Fin.	Pers. Spec.
	<ul style="list-style-type: none"> • Steel plug for padlocks • 2 keys • Pickled brass body • Complete with plate item 1.07573.08.0 	10	10069000000CL	0,106	1	1	0M610	00	0	00	CL
	<ul style="list-style-type: none"> • Cylinder for outside operation devices item 1.07078.28.0 	10	10069000000CL	0,117	1	1	0M610	10	0	12	CL
	<ul style="list-style-type: none"> • Cylinder for outside operation devices item 1.07078.29.0 	10	10069000000CL	0,117	1	1	0M610	11	0	12	CL
 	<ul style="list-style-type: none"> • Key extraction position (0) • Deadbolt item 1.06414.20.0 or 1.06414.30.0 (to order separately) 	17	1010069000000CL	0,150	1	1	0M410	00	0	12	CL
 	<ul style="list-style-type: none"> • Microswitch (7 A, 250 V) with terminals to be welded • Automatic return to key extraction position (0) 	17	1010069000000CL	0,150	1	1	0M415	01	0	12	CL
 	<ul style="list-style-type: none"> • Microswitch (7 A, 250 V) with terminals to be welded • Automatic return to key extraction position (0) 	17	1010069000000CL	0,150	1	1	0M415	03	0	12	CL



Technical features:

- BKP (bumping resistant) registered patented
- 10 pins (6 active, 4 passive) key biting system
- **Brass body with dual-material SNAP RESISTANT core**
- brass body with segment pack extended through the entire length of the cylinder brass plugs
- self-lubricating sintered steel projecting DIN CAM
- pins and drivers in hardened steel
- phosphor bronze springs
- Flat reversible key
 - in a special brass alloy nickel-plated
 - numbered on key head

Supplied as standard:

- 3 keys
- Code Card
- Fixing screw
- Operating and Maintenance Instructions.

On request:

- Key with long neck (pers. CL), with personalised plastic piece and profile (pers. CP)

Finishes:

- Standard: sanded brass (fin. 00)
- On request:
 - nickel-plated brass (fin. 12)
 - polished brass (fin. 66)

Standards:

- Compliant with EN 1303:05
- Attack Resistance: grade C
- Key Related Security: grade 6
- Durability: grade 6

Certifications:

- ICM EN 1303:15 16010C6C
- SKG**

Patents:

- BKP: PCT/WO2007/074163A1

Astral S

Type	Description	Comm. dim.	Key item				Unit weight	Pieces	ITEM			
			L	A	B	Pins			Type	Dim.	Hand	Fin.

• Clutching systems double cylinders

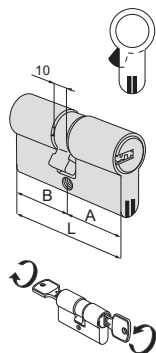

30 / 30	59,0	29,5	29,5	10	1	00620 01 0	0,234	12	1	0A3S1	07 0		
28 / 34	61,2	27,7	33,5	10	1	00620 01 0	0,234	12	1	0A3S1	06 0		
28 / 36	63,2	27,7	35,5	10	1	00620 01 0	0,234	12	1	0A3S1	09 0		
30 / 35	64,0	29,5	34,5	10	1	00620 01 0	0,243	12	1	0A3S1	26 0		
33 / 33	65,0	32,5	32,5	10	1	00620 01 0	0,234	12	1	0A3S1	10 0		
35 / 35	69,0	34,5	34,5	10	1	00620 01 0	0,234	12	1	0A3S1	13 0		
40 / 30	69,0	39,5	29,5	10	1	00620 01 0	0,234	12	1	0A3S1	12 0		
28 / 43	70,2	27,7	42,5	10	1	00620 01 0	0,234	12	1	0A3S1	11 0		
30 / 45	74,0	29,5	44,5	10	1	00620 01 0	0,243	12	1	0A3S1	27 0		
35 / 40	74,0	34,5	39,5	10	1	00620 01 0	0,243	12	1	0A3S1	28 0		
30 / 50	79,0	29,5	49,5	10	1	00620 01 0	0,234	12	1	0A3S1	17 0		
35 / 45	79,0	34,5	44,5	10	1	00620 01 0	0,234	12	1	0A3S1	19 0		
40 / 40	79,0	39,5	39,5	10	1	00620 01 0	0,234	12	1	0A3S1	18 0		
30 / 55	84,0	29,5	54,5	10	1	00620 01 0	0,304	12	1	0A3S1	33 0		
35 / 50	84,0	34,5	49,5	10	1	00620 01 0	0,319	12	1	0A3S1	31 0		
40 / 45	84,0	39,5	44,5	10	1	00620 01 0	0,319	12	1	0A3S1	30 0		
43 / 43	85,0	42,5	42,5	10	1	00620 01 0	0,304	12	1	0A3S1	46 0		
30 / 60	89,0	29,5	59,5	10	1	00620 01 0	0,304	12	1	0A3S1	20 0		
35 / 55	89,0	34,5	54,5	10	1	00620 01 0	0,304	12	1	0A3S1	32 0		
40 / 50	89,0	39,5	49,5	10	1	00620 01 0	0,319	12	1	0A3S1	21 0		
45 / 45	89,0	44,5	44,5	10	1	00620 01 0	0,319	12	1	0A3S1	29 0		
30 / 65	94,0	29,5	64,5	10	1	00620 01 0	0,319	6	1	0A3S1	41 0		
35 / 60	94,0	34,5	59,5	10	1	00620 01 0	0,304	6	1	0A3S1	38 0		
40 / 55	94,0	29,5	64,5	10	1	00620 01 0	0,319	6	1	0A3S1	42 0 12		
45 / 50	94,0	44,5	49,5	10	1	00620 01 0	0,304	6	1	0A3S1	39 0		
30 / 70	99,0	29,5	69,5	10	1	00620 01 0	0,349	6	1	0A3S1	24 0		
35 / 65	99,0	34,5	64,5	10	1	00620 01 0	0,319	6	1	0A3S1	22 0		
40 / 60	99,0	39,5	59,5	10	1	00620 01 0	0,349	6	1	0A3S1	25 0		
45 / 55	99,0	44,5	54,5	10	1	00620 01 0	0,349	6	1	0A3S1	43 0		
50 / 50	99,0	49,5	49,5	10	1	00620 01 0	0,319	6	1	0A3S1	23 0		
30 / 75	104,0	29,5	74,5	10	1	00620 01 0	0,234	6	1	0A3S1	56 0		
35 / 70	104,0	34,5	69,5	10	1	00620 01 0	0,234	6	1	0A3S1	49 0		
50 / 55	104,0	49,5	54,5	10	1	00620 01 0	0,234	6	1	0A3S1	64 0		
30 / 80	109,0	29,5	79,5	10	1	00620 01 0	0,349	6	1	0A3S1	37 0		
40 / 70	109,0	39,5	69,5	10	1	00620 01 0	0,349	6	1	0A3S1	35 0		
50 / 60	109,0	49,5	59,5	10	1	00620 01 0	0,319	6	1	0A3S1	36 0		
55 / 55	109,0	54,5	54,5	10	1	00620 01 0	0,319	6	1	0A3S1	70 0		
30 / 85	114,0	29,5	84,5	10	1	00620 01 0	0,234	6	1	0A3S1	77 0		
50 / 65	114,0	49,5	64,5	10	1	00620 01 0	0,234	6	1	0A3S1	65 0		
40 / 75	114,0	39,5	74,5	10	1	00620 01 0	0,234	6	1	0A3S1	59 0		

Type	Description	Comm. dim.				Key item	Kg	Pieces	ITEM				
		L	A	B	Pin				Type	Dim.	Hand	Fin.	Pers.

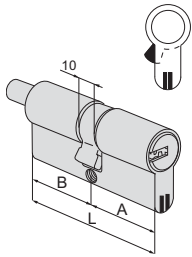

- Double cylinders with thumb turn shaft
- ON REQUEST:
- Knobs series 06353, 06355, 06356, 06357

30 / 30	59,0	29,5	29,5	10	1	00620 01 0	0,275	12	1	OA352	07 0
30 / 35	64,0	29,5	34,5	10	1	00620 01 0	0,264	12	1	OA352	26 0
35 / 30	64,0	34,5	29,5	10	1	00620 01 0	0,264	12	1	OA352	81 0
33 / 33	65,0	32,5	32,5	10	1	00620 01 0	0,264	12	1	OA352	10 0
30 / 40	69,0	29,5	39,5	10	1	00620 01 0	0,264	12	1	OA352	82 0
35 / 35	69,0	34,5	34,5	10	1	00620 01 0	0,264	12	1	OA352	13 0
35 / 40	74,0	34,5	39,5	10	1	00620 01 0	0,294	12	1	OA352	28 0
40 / 35	74,0	39,5	34,5	10	1	00620 01 0	0,294	12	1	OA352	83 0
30 / 50	79,0	29,5	49,5	10	1	00620 01 0	0,318	6	1	OA352	17 0
35 / 45	79,0	34,5	44,5	10	1	00620 01 0	0,318	6	1	OA352	19 0
40 / 40	79,0	39,5	39,5	10	1	00620 01 0	0,318	6	1	OA352	18 0
40 / 45	84,0	39,5	44,5	10	1	00620 01 0	0,324	6	1	OA352	30 0
45 / 40	84,0	44,5	39,5	10	1	00620 01 0	0,324	6	1	OA352	84 0
50 / 35	84,0	49,5	34,5	10	1	00620 01 0	0,324	6	1	OA352	94 0
43 / 43	85,0	42,5	42,5	10	1	00620 01 0	0,324	6	1	OA352	46 0
30 / 60	89,0	29,5	59,5	10	1	00620 01 0	0,324	6	1	OA352	20 0
40 / 50	89,0	39,5	49,5	10	1	00620 01 0	0,324	6	1	OA352	21 0
45 / 45	89,0	44,5	44,5	10	1	00620 01 0	0,324	6	1	OA352	29 0
40 / 55	94,0	39,5	54,5	10	1	00620 01 0	0,367	6	1	OA352	42 0
55 / 40	94,0	54,5	39,5	10	1	00620 01 0	0,367	6	1	OA352	98 0
45 / 50	94,0	44,5	49,5	10	1	00620 01 0	0,367	6	1	OA352	39 0
40 / 60	99,0	39,5	59,5	10	1	00620 01 0	0,370	6	1	OA352	25 0
45 / 55	99,0	44,5	54,5	10	1	00620 01 0	0,370	6	1	OA352	43 0
50 / 50	99,0	49,5	49,5	10	1	00620 01 0	0,370	6	1	OA352	23 0
45 / 60	104,0	44,5	59,5	10	1	00620 01 0	0,398	6	1	OA352	54 0
30 / 80	109,0	29,5	79,5	10	1	00620 01 0	0,400	6	1	OA352	37 0
40 / 70	109,0	39,5	69,5	10	1	00620 01 0	0,400	6	1	OA352	35 0
55 / 55	109,0	54,5	54,5	10	1	00620 01 0	0,400	6	1	OA352	70 0
60 / 50	109,0	59,5	49,5	10	1	00620 01 0	0,400	6	1	OA352	89 0
55 / 60	114,0	54,5	59,5	10	1	00620 01 0	0,415	6	1	OA352	71 0
55 / 65	119,0	54,5	64,5	10	1	00620 01 0	0,430	6	1	OA352	72 0
60 / 60	119,0	59,5	59,5	10	1	00620 01 0	0,430	6	1	OA352	40 0
65 / 55	119,0	64,5	54,5	10	1	00620 01 0	0,430	6	1	OA352	86 0

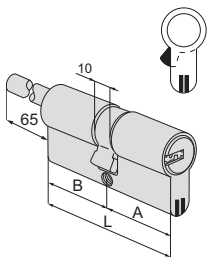

- Double cylinders with adjustable thumb turn shaft
- to be combined with inside rose item 1.06458.20
- ON REQUEST:
- Knobs series 06353, 06355, 06356, 06357

30 / 30	59,0	29,5	29,5	10	1	00620 01 0	0,275	6	1	OA357	07 0
35 / 30	64,0	34,5	29,5	10	1	00620 01 0	0,275	6	1	OA357	81 0
40 / 30	69,0	39,5	29,5	10	1	00620 01 0	0,264	6	1	OA357	12 0
45 / 30	74,0	44,5	29,5	10	1	00620 01 0	0,264	6	1	OA357	91 0
50 / 30	79,0	49,5	29,5	10	1	00620 01 0	0,329	6	1	OA357	90 0
55 / 30	84,0	54,5	29,5	10	1	00620 01 0	0,359	6	1	OA357	92 0
60 / 30	89,0	59,5	29,5	10	1	00620 01 0	0,359	6	1	OA357	87 0
70 / 30	99,0	69,5	29,5	10	1	00620 01 0	0,370	6	1	OA357	88 0

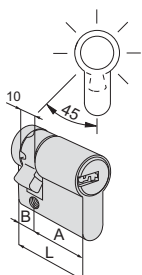

- Single cylinder with adjustable cam in 8 position

30 / 10	39,5	29,5	10,0	10	1	00620 01 0	0,186	12	1	OA314	02 0
35 / 10	44,5	34,5	10,0	10	1	00620 01 0	0,201	12	1	OA314	07 0
40 / 10	49,5	39,5	10,0	10	1	00620 01 0	0,199	12	1	OA314	03 0
50 / 10	59,5	49,5	10,0	10	1	00620 01 0	0,227	12	1	OA314	04 0
60 / 10	69,5	59,5	10,0	10	1	00620 01 0	0,257	12	1	OA314	05 0



Technical features:

- 10 (6 active + 4 passive) pins key biting system
- brass body
- brass plug
- pins:
 - in hardened steel
- drivers:
 - in brass
 - in hardened steel in first position
- phosphor bronze springs

KEY:

- flat reversible keys
- in nickel-plated brass
- numbered on key bow

Supplied as standard:

- 3 keys
- Code Card
- Fixing screws
- Fixing plates

Finishes:

- **STANDARD:**
 - sanded brass (fin. 00)
- **ON REQUEST:**
 - nickel-plated brass (fin. 12)
 - polished brass (fin. 66)

Astral

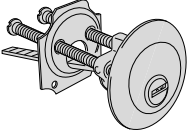
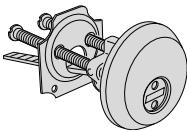
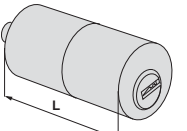
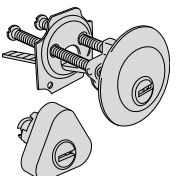
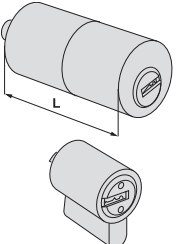
Type	Description	For locks series	Key item		Unit weight	Pieces	ITEM								
			L	Pins			Kg	Type	Dim.	Hand	Fin.	Pers.	Spec.		
	• Rim cylinder	1A610, 11610, 50110, 50130, 50180, 50330, 54310, 54315, 54340, 54510, 54550, 54552, 54570	10	1 00620 01 0	0,204	6	1	0A510	00	0					
	• Rim cylinder with nickel-plated tear and drill resistant rose		10	1 00620 01 0	0,270	6	1	0A510	11	0					
	• Round cylinder • For further lenght see item 07165	1A611, 11611, 50111, 50131, 50181, 50411, 50481, 50511, 50581, 54316, 54341	50,0	10 1 00620 01 0	0,160	6	1	0A210	50	0					
	• Cylinder set	50120, 50125, 50160, 50170, 50210, 50220	10	1 00620 01 0	0,267	6	1	0A112	00	0					
		11630	10	1 00620 01 0	0,267	6	1	0A114	00	0					
	• Cylinder set, with round external cylinder	1A631, 1A721, 1A731	55,0	10 1 00620 01 0	0,233	6	1	0A150	00	0					

Type	Description	For locks series	Key item		Unit weight	Pieces	ITEM				
			L	Pins			Type	Dim.	Hand	Fin.	Pers.

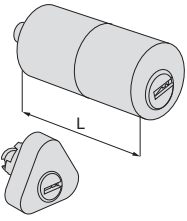

- Cylinder set, with round external cylinder

50121, 50126, 50141,
50161, 50171, 50211,
50221, 50421, 50461,
50471, 50521, 50561,
50571

50,0 10 1 00620 01 0 0,233 6 1

0A116 00 0

11631, 11731, 11931

50,0 10 1 00620 01 0 0,253 6 1

0A120 00 0

11721, 11921

50,0 10 1 00620 01 0 0,253 6 1

0A149 00 0

11671, 11761, 11771

50,0 10 1 00620 01 0 0,253 6 1

0A155 00 0

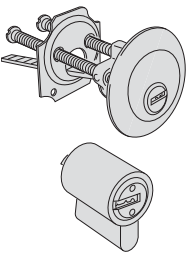

- Cylinder set

1A630

10 1 00620 01 0 0,267 6 1

0A115 00 0



Technical features:

- 10 pins key biting system
- brass body
- brass plug
- pins:
 - in wear resistant bronze
 - in hardened steel in first position
- drivers:
 - in brass
 - in hardened steel in first position
- phosphor bronze springs

KEY:

- flat reversible keys
- in nickel-plated brass
- numbered on key bow

Supplied as standard:

- 3 keys
- Code Card
- Fixing screws
- Fixing plates

Finishes:

- Nickel-plated brass (fin. 12)

Astral

Type	Description	Door thickness	Pins	Key item	Unit weight	Pieces	ITEM					
							Type	Dim.	Hand	Fin.	Pers.	Spec.
	<ul style="list-style-type: none"> • Small cylinder for padlocks: series 28053 - 28353 - 28553 • 2 keys • Pickled brass body • Complete with plate 	10	1	00620 01 0	0,106	6	1	0A610	00	0		
	<ul style="list-style-type: none"> • Cylinder for outside operation devices item 1.07078.28.0 	10	1	00620 01 0	0,106	6	1	0A610	10	0		
	<ul style="list-style-type: none"> • Cylinder for outside operation devices item 1.07078.29.0 	10	1	00620 01 0	0,106	6	1	0A610	11	0		
	<ul style="list-style-type: none"> • Vertical key extraction • Deadbolt item 1.06414.20.0 or item 1.06414.30.0 (to order separately) 	17	10	1 00620 01 0	0,195	6	1	0A410	00	0		
	<ul style="list-style-type: none"> • Microswitch (7 A, 250 V) with terminals to be welded • Automatic return to key extraction position (0) 	17	10	1 00620 01 0	0,140	6	1	0A415	01	0		
	<ul style="list-style-type: none"> • Microswitch (7 A, 250 V) with terminals to be welded • Automatic return to key extraction position (0) 	17	10	1 00620 01 0	0,188	6	1	0A415	03	0		



AsixP8

Technical features:

- CYLINDER**
- BKP Resistance to bumping
 - 8-pin key biting system (6 active, 2 passive)
 - Brass body
 - Brass plugs
 - Clutch-type DIN cam in self-lubricating sintered steel
 - Hardened steel pins
 - Hardened steel drivers
 - Double side control steel pin
 - Phosphor bronze and steel springs
- KEY**
- flat reversible
 - in nickel-plated brass
 - Key blade 17 mm long, compatible with protective roses.

- Key head with ergonomic removable plastic insert.
- Numerical code on key bow.
- Key thickness 2.9 mm.
- Depth 0.48 mm

Supplied as standard:

- 3 keys with 3 plastic insert
- Personal Card
- Fixing screw

Finishes:

- Standard: nickel-plated brass (fin. 12)
- On request: sanded brass (fin. 00).

Standards:

- In compliance with EN 1303:15
- Attack Resistance: grade C
- Key Related Security: grade 6
- Durability: grade 6

Patents:

- BKP PCT/WO 2007/074163A1
- Certified protection against bumping

Certificates:

- SKG **
- BSI*
- ICM

Type	Description	Comm. dim.	Key item	Kg	Pieces	ITEM			
						Type	Dim.	Hand	Fin.

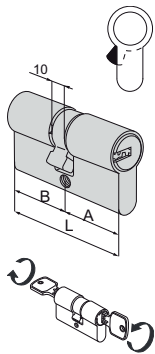

- Double cylinder with clutch system

30 / 30	59,0	29,5	29,5	8	1 00670 10 0	0,235	6	1	0Q311 07 0 12
28 / 34	61,2	27,7	33,5	8	1 00670 10 0	0,235	6	1	0Q311 06 0 12
28 / 36	63,2	27,7	35,5	8	1 00670 10 0	0,235	6	1	0Q311 09 0 12
30 / 35	64,0	29,5	34,5	8	1 00670 10 0	0,240	6	1	0Q311 26 0 12
33 / 33	65,0	32,5	32,5	8	1 00670 10 0	0,240	6	1	0Q311 10 0 12
35 / 35	69,0	34,5	34,5	8	1 00670 10 0	0,270	6	1	0Q311 13 0 12
40 / 30	69,0	39,5	29,5	8	1 00670 10 0	0,270	6	1	0Q311 12 0 12
28 / 43	70,2	27,7	42,5	8	1 00670 10 0	0,270	6	1	0Q311 11 0 12
30 / 45	74,0	29,5	44,5	8	1 00670 10 0	0,280	6	1	0Q311 27 0 12
35 / 40	74,0	34,5	39,5	8	1 00670 10 0	0,280	6	1	0Q311 28 0 12
30 / 50	79,0	29,5	49,5	8	1 00670 10 0	0,300	6	1	0Q311 17 0 12
35 / 45	79,0	34,5	44,5	8	1 00670 10 0	0,300	6	1	0Q311 19 0 12
40 / 40	79,0	39,5	39,5	8	1 00670 10 0	0,300	6	1	0Q311 18 0 12
30 / 55	84,0	29,5	54,5	8	1 00670 10 0	0,320	6	1	0Q311 33 0 12
35 / 50	84,0	34,5	49,5	8	1 00670 10 0	0,320	6	1	0Q311 31 0 12
40 / 45	84,0	39,5	44,5	8	1 00670 10 0	0,320	6	1	0Q311 30 0 12
30 / 60	89,0	29,5	59,5	8	1 00670 10 0	0,340	6	1	0Q311 20 0 12
35 / 55	89,0	34,5	54,5	8	1 00670 10 0	0,340	6	1	0Q311 32 0 12
40 / 50	89,0	39,5	49,5	8	1 00670 10 0	0,340	6	1	0Q311 21 0 12
45 / 45	89,0	44,5	44,5	8	1 00670 10 0	0,340	6	1	0Q311 29 0 12
30 / 65	94,0	29,5	64,5	8	1 00670 10 0	0,360	6	1	0Q311 41 0 12
35 / 60	94,0	34,5	59,5	8	1 00670 10 0	0,360	6	1	0Q311 38 0 12
40 / 55	94,0	39,5	54,5	8	1 00670 10 0	0,360	6	1	0Q311 42 0 12
45 / 50	94,0	44,5	49,5	8	1 00670 10 0	0,360	6	1	0Q311 39 0 12
30 / 70	99,0	29,5	69,5	8	1 00670 10 0	0,380	6	1	0Q311 24 0 12
35 / 65	99,0	34,5	64,5	8	1 00670 10 0	0,380	6	1	0Q311 22 0 12
40 / 60	99,0	39,5	59,5	8	1 00670 10 0	0,380	6	1	0Q311 25 0 12
45 / 55	99,0	44,5	54,5	8	1 00670 10 0	0,380	6	1	0Q311 43 0 12
50 / 50	99,0	49,5	59,5	8	1 00670 10 0	0,380	6	1	0Q311 23 0 12
40 / 65	104,0	39,5	64,5	8	1 00670 10 0	0,400	6	1	0Q311 44 0 12
45 / 60	104,0	44,5	59,5	8	1 00670 10 0	0,400	6	1	0Q311 54 0 12
30 / 75	104,0	29,5	74,5	8	1 00670 10 0	0,400	6	1	0Q311 56 0 12
35 / 70	104,0	34,5	69,5	8	1 00670 10 0	0,400	6	1	0Q311 49 0 12
55 / 50	104,0	54,5	49,5	8	1 00670 10 0	0,400	6	1	0Q311 64 0 12
35 / 75	109,0	34,5	74,5	8	1 00670 10 0	0,420	6	1	0Q311 57 0 12
30 / 80	109,0	29,5	79,5	8	1 00670 10 0	0,420	6	1	0Q311 37 0 12
45 / 65	109,0	44,5	64,5	8	1 00670 10 0	0,420	6	1	0Q311 45 0 12
40 / 70	109,0	39,5	69,5	8	1 00670 10 0	0,420	6	1	0Q311 35 0 12
50 / 60	109,0	49,5	59,5	8	1 00670 10 0	0,420	6	1	0Q311 36 0 12
55 / 55	109,0	54,5	54,5	8	1 00670 10 0	0,420	6	1	0Q311 70 0 12
30 / 85	114,0	29,5	84,5	8	1 00670 10 0	0,440	6	1	0Q311 77 0 12
50 / 65	114,0	49,5	64,5	8	1 00670 10 0	0,440	6	1	0Q311 65 0 12

Type	Description	Comm. dim.				Key item	Kg	Pcs	ITEM				
		L	A	B	pins				Type	Dim.	Hand	Fin.	Pers.

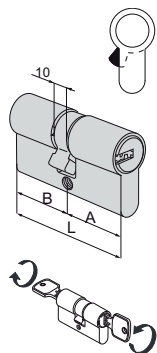

- Double cylinder with clutch system

55 / 60	114,0	54,5	59,5	8	1	00670 10 0	0,440	6	1	0Q311 71 0 12
40 / 75	114,0	39,5	74,5	8	1	00670 10 0	0,440	6	1	0Q311 59 0 12
45 / 70	114,0	44,5	69,5	8	1	00670 10 0	0,440	6	1	0Q311 61 0 12
30 / 90	119,0	29,5	89,5	8	1	00670 10 0	0,460	6	1	0Q311 52 0 12
40 / 80	119,0	39,5	79,5	8	1	00670 10 0	0,460	6	1	0Q311 60 0 12
60 / 60	119,0	59,5	59,5	8	1	00670 10 0	0,460	6	1	0Q311 40 0 12
50 / 70	119,0	49,5	69,5	8	1	00670 10 0	0,460	6	1	0Q311 66 0 12
30 / 100	129,0	29,5	99,5	8	1	00670 10 0	0,500	1	1	0Q311 53 0 12

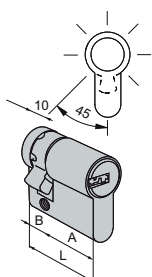

- Single cylinder with adjustable cam in 8 position
- Art. 10Q31418012 fixed cam

25 / 10	34,5	24,5	10,0	8	1	00670 10 0	0,160	6	1	0Q314 18 0 12
30 / 10	39,5	29,5	10,0	8	1	00670 10 0	0,160	6	1	0Q314 02 0 12
35 / 10	44,5	34,5	10,0	8	1	00670 10 0	0,180	6	1	0Q314 07 0 12
40 / 10	49,5	39,5	10,0	8	1	00670 10 0	0,200	6	1	0Q314 03 0 12
45 / 10	54,5	44,5	10,0	8	1	00670 10 0	0,220	6	1	0Q314 08 0 12
50 / 10	59,5	49,5	10,0	8	1	00670 10 0	0,240	6	1	0Q314 04 0 12
55 / 10	64,5	54,5	10,0	8	1	00670 10 0	0,260	6	1	0Q314 35 0 12
60 / 10	69,5	59,5	10,0	8	1	00670 10 0	0,280	6	1	0Q314 05 0 12
65 / 10	74,5	64,5	10,0	8	1	00670 10 0	0,300	6	1	0Q314 21 0 12
70 / 10	79,5	69,5	10,0	8	1	00670 10 0	0,320	6	1	0Q314 06 0 12
80 / 10	89,5	79,5	10,0	8	1	00670 10 0	0,360	6	1	0Q314 20 0 12
95 / 10	104,5	95,5	10,0	8	1	00670 10 0	0,400	6	1	0Q314 13 0 12

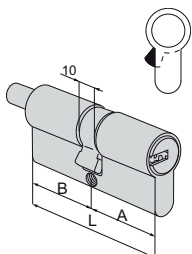

- Double cylinder with thumb turn shaft
- ON REQUEST:
Knobs series 06353, 06355, 06356, 06357

30 / 30	59,0	29,5	29,5	8	1	00670 10 0	0,235	6	1	0Q312 07 0 12
30 / 35	64,0	29,5	34,5	8	1	00670 10 0	0,240	6	1	0Q312 26 0 12
35 / 30	64,0	34,5	29,5	8	1	00670 10 0	0,240	6	1	0Q312 81 0 12
33 / 33	65,0	32,5	32,5	8	1	00670 10 0	0,235	6	1	0Q312 10 0 12
30 / 40	69,0	29,5	39,5	8	1	00670 10 0	0,270	6	1	0Q312 82 0 12
35 / 35	69,0	34,5	34,5	8	1	00670 10 0	0,270	6	1	0Q312 13 0 12
40 / 30	69,0	39,5	29,5	8	1	00670 10 0	0,270	6	1	0Q312 12 0 12
35 / 40	74,0	34,5	39,5	8	1	00670 10 0	0,280	6	1	0Q312 28 0 12
30 / 45	74,0	29,5	44,5	8	1	00670 10 0	0,280	6	1	0Q312 27 0 12
40 / 35	74,0	39,5	34,5	8	1	00670 10 0	0,280	6	1	0Q312 83 0 12
45 / 30	74,0	44,5	29,5	8	1	00670 10 0	0,280	6	1	0Q312 91 0 12
30 / 50	79,0	29,5	49,5	8	1	00670 10 0	0,300	6	1	0Q312 17 0 12
35 / 45	79,0	34,5	44,5	8	1	00670 10 0	0,300	6	1	0Q312 19 0 12
40 / 40	79,0	39,5	39,5	8	1	00670 10 0	0,300	6	1	0Q312 18 0 12
40 / 45	84,0	39,5	44,5	8	1	00670 10 0	0,320	6	1	0Q312 30 0 12
30 / 60	89,0	29,5	59,5	8	1	00670 10 0	0,340	6	1	0Q312 20 0 12
40 / 50	89,0	39,5	49,5	8	1	00670 10 0	0,340	6	1	0Q312 21 0 12
45 / 45	89,0	44,5	44,5	8	1	00670 10 0	0,340	6	1	0Q312 29 0 12
45 / 50	94,0	44,5	49,5	8	1	00670 10 0	0,360	6	1	0Q312 39 0 12
40 / 60	99,0	39,5	59,5	8	1	00670 10 0	0,380	6	1	0Q312 25 0 12
50 / 50	99,0	49,5	49,5	8	1	00670 10 0	0,380	6	1	0Q312 23 0 12

Type	Description	Comm. dim.				Key item	Kg	Pieces	ITEM					
		L	A	B	Pins				Type	Dim.	Hand	Fin.	Pers. Spec.	
<ul style="list-style-type: none"> • Double cylinder with adjustable thumb turn shaft • To be combined with inside rose item 1.06458.20 • ON REQUEST: • Knobs series: 06353, 06355, 06356, 06357 	30 / 30	59,0	29,5	29,5	8	1 00670 10 0	0,240	6	1	0Q317 07 0 12				
	35 / 30	64,0	34,5	29,5	8	1 00670 10 0	0,260	1	1	0Q317 81 0 12				
	40 / 30	69,0	39,5	29,5	8	1 00670 10 0	0,280	1	1	0Q317 12 0 12				
	45 / 30	74,0	44,5	29,5	8	1 00670 10 0	0,300	1	1	0Q317 91 0 12				
	50 / 30	79,0	49,5	29,5	8	1 00670 10 0	0,320	1	1	0Q317 90 0 12				
	55 / 30	84,0	54,5	29,5	8	1 00670 10 0	0,340	1	1	0Q317 92 0 12				
	60 / 30	89,0	59,5	29,5	8	1 00670 10 0	0,360	1	1	0Q317 87 0 12				
	65 / 30	94,0	64,5	29,5	8	1 00670 10 0	0,380	1	1	0Q317 A3 0 12				
	70 / 30	99,0	69,5	29,5	8	1 00670 10 0	0,400	1	1	0Q317 88 0 12				
	80 / 30	109,0	79,5	29,5	8	1 00670 10 0	0,430	1	1	0Q317 93 0 12				
	90 / 30	119,0	89,5	29,5	8	1 00670 10 0	0,460	1	1	0Q317 C6 0 12				
	100 / 30	129,0	99,5	29,5	8	1 00670 10 0	0,460	1	1	0Q317 C7 0 12				



EN 1303:15	KEY RELATED SECURITY	1	2	3	4	5	6
	ATTACK RESISTANCE	0	A	B	C	D	
	DURABILITY	1	2	3	4	5	6

AsixP8PRO

Technical features:

- CYLINDER**
- BKP Resistance to bumping
 - 8-pin key biting system (6 active, 2 passive)
 - Brass body
 - Brass plugs
 - DIN cam in self-lubricating sintered steel
 - Hardened steel pins
 - Hardened steel drivers
 - Double side control steel pin
 - Phosphor bronze and steel springs
- KEY**
- flat reversible
 - in nickel-plated brass
 - Key blade 17 mm long, compatible with protective roses.
 - Key head with ergonomic removable plastic insert.

- Numerical code on key bow.
- Key thickness 2.9 mm.
- Depth 0.48 mm

Supplied as standard:

- 5 keys with 5 plastic insert
- 1 construction key with 1 plastic insert
- Personal Card
- Fixing screw

Finishes:

- Standard: nickel-plated brass (fin. 12)
- On request: sanded brass (fin. 00).

Standards:

- In compliance with EN 1303:2015
- Attack Resistance: grade C
- Key Related Security: grade 6
- Durability: grade 6

- **Patents**
BKP PCT/WO 2007/074163A1
- Certified protection against bumping

Certificates:

- SKG **
- BSI*
- ICM

Type	Description	Comm. dim.	Key item				Kg	Pieces	ITEM			
			L	A	B	Pins			Type	Dim.	Hand	Fin.

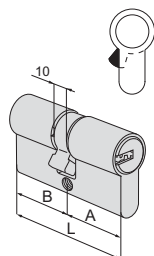

- Double cylinder
- Configuration construction key 1+5

30 / 30	59,0	29,5	29,5	8	1	00670	10 0	0,223	6	1	0Q310	07 0	12	SD
28 / 32	59,0	27,5	31,5	8	1	00670	10 0	0,223	6	1	0Q310	08 0	12	SD
30 / 35	64,0	29,5	34,5	8	1	00670	10 0	0,240	6	1	0Q310	26 0	12	SD
35 / 35	69,0	34,5	34,5	8	1	00670	10 0	0,260	6	1	0Q310	13 0	12	SD
40 / 30	69,0	39,5	29,5	8	1	00670	10 0	0,260	6	1	0Q310	12 0	12	SD
30 / 45	74,0	29,5	44,5	8	1	00670	10 0	0,280	6	1	0Q310	27 0	12	SD
35 / 40	74,0	34,5	39,5	8	1	00670	10 0	0,280	6	1	0Q310	28 0	12	SD
30 / 50	79,0	29,5	49,5	8	1	00670	10 0	0,300	6	1	0Q310	17 0	12	SD
35 / 45	79,0	34,5	44,5	8	1	00670	10 0	0,300	6	1	0Q310	19 0	12	SD
40 / 40	79,0	39,5	39,5	8	1	00670	10 0	0,300	6	1	0Q310	18 0	12	SD
30 / 55	84,0	29,5	54,5	8	1	00670	10 0	0,320	6	1	0Q310	33 0	12	SD
35 / 50	84,0	34,5	49,5	8	1	00670	10 0	0,320	6	1	0Q310	31 0	12	SD
40 / 45	84,0	39,5	44,5	8	1	00670	10 0	0,320	6	1	0Q310	30 0	12	SD
35 / 55	89,0	34,5	54,5	8	1	00670	10 0	0,340	6	1	0Q310	32 0	12	SD
30 / 60	89,0	29,5	59,5	8	1	00670	10 0	0,340	6	1	0Q310	20 0	12	SD
40 / 50	89,0	39,5	49,5	8	1	00670	10 0	0,340	6	1	0Q310	21 0	12	SD
45 / 45	89,0	44,5	44,5	8	1	00670	10 0	0,340	6	1	0Q310	29 0	12	SD
35 / 60	94,0	34,5	59,5	8	1	00670	10 0	0,360	6	1	0Q310	38 0	12	SD
45 / 50	94,0	44,5	49,5	8	1	00670	10 0	0,360	6	1	0Q310	39 0	12	SD
30 / 70	99,0	29,5	69,5	8	1	00670	10 0	0,380	6	1	0Q310	24 0	12	SD
40 / 60	99,0	39,5	59,5	8	1	00670	10 0	0,380	6	1	0Q310	25 0	12	SD
35 / 65	99,0	34,5	64,5	8	1	00670	10 0	0,380	6	1	0Q310	22 0	12	SD
50 / 50	99,0	49,5	59,5	8	1	00670	10 0	0,380	6	1	0Q310	23 0	12	SD
45 / 55	99,0	44,5	54,5	8	1	00670	10 0	0,340	6	1	0Q310	43 0	12	SD
45 / 60	104,0	44,5	59,5	8	1	00670	10 0	0,340	6	1	0Q310	54 0	12	SD
55 / 55	109,0	44,5	44,5	8	1	00670	10 0	0,340	6	1	0Q310	70 0	12	SD
40 / 70	109,0	39,5	69,5	8	1	00670	10 0	0,400	6	1	0Q310	35 0	12	SD
50 / 60	109,0	49,5	59,5	8	1	00670	10 0	0,400	6	1	0Q310	36 0	12	SD
30 / 80	109,0	29,5	79,5	8	1	00670	10 0	0,400	6	1	0Q310	37 0	12	SD
50 / 70	119,0	49,5	69,5	8	1	00670	10 0	0,400	6	1	0Q310	66 0	12	SD
30 / 90	119,0	29,5	89,5	8	1	00670	10 0	0,400	6	1	0Q310	52 0	12	SD
40 / 80	119,0	39,5	79,5	8	1	00670	10 0	0,400	6	1	0Q310	60 0	12	SD

Type	Description	Comm. dim.				Key item	Kg	Pieces	ITEM			
		L	A	B	Pins				Type	Dim.	Hand	Fin.

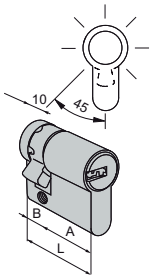

- Single cylinder with 8-position adjustable cam
- Item 10Q31418012 fixed cam
- Configuration construction key 1+2
- KA series configuration construction key 1+1

25 / 10	34,5	24,5	10,0	8	1 00670 10 0	0,164	6	1 Q0314 18 0 12 NV
25 / 10	34,5	24,5	10,0	8	1 00670 10 0	0,164	6	1 Q0314 18 0 12 NV KA
30 / 10	39,5	29,5	10,0	8	1 00670 10 0	0,164	6	1 Q0314 02 0 12 NV
30 / 10	39,5	29,5	10,0	8	1 00670 10 0	0,164	6	1 Q0314 02 0 12 NV KA
35 / 10	44,5	34,5	10,0	8	1 00670 10 0	0,164	6	1 Q0314 07 0 12 NV KA
40 / 10	49,5	39,5	10,0	8	1 00670 10 0	0,164	6	1 Q0314 03 0 12 NV
40 / 10	49,5	39,5	10,0	8	1 00670 10 0	0,164	6	1 Q0314 03 0 12 NV KA

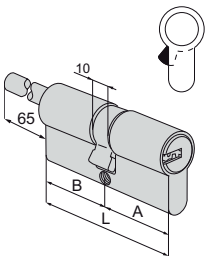

- Double cylinder pre-set for thumb turn installation, with adjustable shaft
- For use with inside escutcheon item 1.06458.20
- On request:
- Thumb turns items 06353, 06355, 06356, 06357
- Configuration construction key 1+5

30 / 30	59,0	29,5	29,5	8	1 00670 10 0	0,260	6	1 Q0317 07 0 12 SD
35 / 30	64,0	34,5	29,5	8	1 00670 10 0	0,280	1	1 Q0317 81 0 12 SD
40 / 30	69,0	39,5	29,5	8	1 00670 10 0	0,300	1	1 Q0317 12 0 12 SD
45 / 30	74,0	44,5	29,5	8	1 00670 10 0	0,320	1	1 Q0317 91 0 12 SD
50 / 30	79,0	49,5	29,5	8	1 00670 10 0	0,340	1	1 Q0317 90 0 12 SD
55 / 30	84,0	54,5	29,5	8	1 00670 10 0	0,360	1	1 Q0317 92 0 12 SD
60 / 30	89,0	59,5	29,5	8	1 00670 10 0	0,380	1	1 Q0317 87 0 12 SD
65 / 30	94,0	64,5	29,5	8	1 00670 10 0	0,400	1	1 Q0317 A3 0 12 SD
70 / 30	99,0	69,5	29,5	8	1 00670 10 0	0,420	1	1 Q0317 88 0 12 SD
80 / 30	109,0	79,5	29,5	8	1 00670 10 0	0,420	1	1 Q0317 93 0 12 SD



AsixP8

Technical features:
CYLINDER

- 8-pin key biting system (6 active, 2 passive)
- Brass body
- Brass plugs
- Hardened steel pins
- Hardened steel drivers
- Double side control steel pin
- Phosphor bronze and steel springs

KEY

- Flat reversible
- Nickel-plated brass
- Key head with ergonomic removable plastic insert.
- Numerical code on key bow.
- Key thickness 2.9 mm.
- Depth 0.48 mm.

Supplied as standard:

- keys with 3 plastic insert
- Personal Card
- Fixing screws

Finishes:

- Standard: nickel-plated brass (fin. 12)
- On request: sanded brass (fin. 00).

Certificates:

- SKG **

Type	Description	For locks series	Key item		Unit weight Kg	Pieces	ITEM								
			L	Pins			Type	Dim.	Hand	Fin.	Pers.	Spec.			
	• Cylinder	1A610, 11540, 11610, 11615, 50010, 50110, 50115, 50130, 50180, 50330, 54310, 50312, 54315, 54340, 54342, 54350, 54352, 54510, 54512, 54550, 54552, 54570, 54572	8	1 00670 10 0	0,204	1	1	0Q510	00	0	12				
	• Cylinder	1A611, 11611, 50111, 50116, 50131, 50181, 50411, 50481, 50511, 50581, 54316, 54341	55,0	8 1 00670 10 0	0,160	1	1	0Q210	55	0	12				
	• Cylinder set	1A631, 1A721, 1A731	55,0	8 1 00670 10 0	0,267	1	1	0Q150	00	0	12				
	• Cylinder set	50121, 50126, 50141, 50161, 50171, 50421, 50461, 50471, 50521, 50561, 50571	50,0	8 1 00670 10 0	0,267	1	1	0Q116	00	0	12				
	• Cylinder set	11551, 11631, 11731, 11736, 11931, 11936	55,0	8 1 00670 10 0	0,267	1	1	0Q120	00	0	12				
	• Cylinder set	11660, 11670		8 1 00670 10 0	0,267	1	1	0Q156	00	0	12				
	• Cylinder set	11521, 11721, 11726, 11921, 11926	55,0	8 1 00670 10 0	0,267	1	1	0Q149	00	0	12				



AsixP8

Technical features:

CYLINDER

- 8-pin key biting system (6 active, 2 passive)
- Brass body
- Brass plugs
- Hardened steel pins
- Hardened steel drivers
- Double side control steel pin
- Phosphor bronze and steel springs

KEY

- Flat reversible
- Nickel-plated brass
- Key head with ergonomic removable plastic insert.
- Numerical code on key bow.
- Key thickness 2.9 mm.
- Depth 0.48 mm.

Supplied as standard:

- 3 keys with 3 plastic insert
- Roses
- Personal card.
- Fixing screws.

Finishes:

- Standard: nickel-plated brass (fin. 12)
- On request: sanded brass (fin. 00).

Certificates:

- SKG **

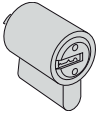
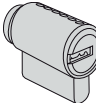
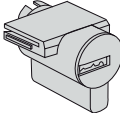
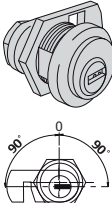
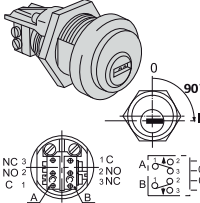
Type	Description	Door thickness	Pins	Key item	Unit weight	Pieces	ITEM								
							Type	Dim.	Hand	Fin.	Pers.	Spec.			
	<ul style="list-style-type: none"> • Steel padlock plug • 2 keys • Pickled brass body • Complete with plate item 1.07573.08.0 	8	1	100670100	0,117	1	1	00	610	00	0				
	<ul style="list-style-type: none"> • Cylinder for outside access device 1.07078.28.0 	8	1	100670100	0,117	1	1	00	610	10	0	12			
	<ul style="list-style-type: none"> • Cylinder for push-to-open Meroni locks 	8	1	100670100	0,117	1	1	00	610	12	0	12			
	<ul style="list-style-type: none"> • Key extraction in position (0) • Ring item 1.06021.10.0 • Deadbolt item 1.06414.20.0 or 1.06414.30.0 to be ordered separately 	17	8	100670100	0,150	1	1	00	410	00	0	12			
	<ul style="list-style-type: none"> • Microswitch (7 A, 250 V) with welding terminals • Automatic return to key extraction position (0) • Ring item 1.06021.10.0 	17	8	100670100	0,150	1	1	00	415	01	0	12			



EN 1303:15	KEY RELATED SECURITY	1	2	3	4	5	6
	ATTACK RESISTANCE	0	A	B	C	D	
	DURABILITY	1	2	3	4	5	6

Asix

Technical features:

- brass body
- brass plugs
- self-lubricating sintered steel projecting DIN cam
- pins:
 - in hardened steel
- drivers:
 - in brass
 - in hardened steel in first position
- phosphor bronze springs
- self-lubricating sintered steel projecting cam, DIN-compatible
- KEY:
 - flat reversible keys
 - in nickel-plated brass
 - long key for protective roses compatibility
 - numerical coding on the head

Supplied as standard:

- 3 keys
- Fixing screw

Finishes:

- STANDARD:
 - sanded brass (fin. 00)
- ON REQUEST:
 - nickel-plated brass (fin. 12)

Standards:

- Compliant with EN 1303:2015
- Attack Resistance: grade 0
- Key Related Security: grade 5
- Durability: grade 6

Type	Description	Comm. dim.	Key item				Kg	Pieces	ITEM			
			L	A	B	Pins			Type	Dim.	Hand	Fin.

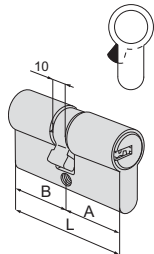

• Double cylinder

28 / 28	55,4	27,7	27,7	6	1	00670 01 0	0,216	6	1	OE300	05	0		
30 / 30	59,0	29,5	29,5	6	1	00670 01 0	0,223	6	1	OE300	07	0		
28 / 32	59,2	27,7	31,5	6	1	00670 01 0	0,225	6	1	OE300	08	0		
28 / 34	61,2	27,7	33,5	6	1	00670 01 0	0,230	6	1	OE300	06	0		
28 / 36	63,2	27,7	35,5	6	1	00670 01 0	0,242	6	1	OE300	09	0		
30 / 35	64,0	29,5	34,5	6	1	00670 01 0	0,233	6	1	OE300	26	0		
33 / 33	65,0	32,5	32,5	6	1	00670 01 0	0,242	6	1	OE300	10	0		
35 / 35	69,0	34,5	34,5	6	1	00670 01 0	0,267	6	1	OE300	13	0		
40 / 30	69,0	39,5	29,5	6	1	00670 01 0	0,258	6	1	OE300	12	0		
28 / 43	70,2	27,7	42,5	6	1	00670 01 0	0,275	6	1	OE300	11	0		
30 / 45	74,0	29,5	44,5	6	1	00670 01 0	0,264	6	1	OE300	27	0		
35 / 40	74,0	34,5	39,5	6	1	00670 01 0	0,264	6	1	OE300	28	0		
30 / 50	79,0	29,5	49,5	6	1	00670 01 0	0,279	6	1	OE300	17	0		
35 / 45	79,0	34,5	44,5	6	1	00670 01 0	0,279	6	1	OE300	19	0		
40 / 40	79,0	39,5	39,5	6	1	00670 01 0	0,279	6	1	OE300	18	0		
30 / 55	84,0	29,5	54,5	6	1	00670 01 0	0,294	6	1	OE300	33	0		
35 / 50	84,0	34,5	49,5	6	1	00670 01 0	0,294	6	1	OE300	31	0		
40 / 45	84,0	39,5	44,5	6	1	00670 01 0	0,294	6	1	OE300	30	0		
30 / 60	89,0	29,5	59,5	6	1	00670 01 0	0,323	6	1	OE300	20	0		
35 / 55	89,0	34,5	54,5	6	1	00670 01 0	0,310	6	1	OE300	32	0		
40 / 50	89,0	39,5	49,5	6	1	00670 01 0	0,310	6	1	OE300	21	0		
45 / 45	89,0	44,5	44,5	6	1	00670 01 0	0,310	6	1	OE300	29	0		
30 / 65	94,0	29,5	64,5	6	1	00670 01 0	0,324	6	1	OE300	41	0		
35 / 60	94,0	34,5	59,5	6	1	00670 01 0	0,324	6	1	OE300	38	0		
40 / 55	94,0	39,5	54,5	6	1	00670 01 0	0,341	6	1	OE300	42	0		
45 / 50	94,0	44,5	49,5	6	1	00670 01 0	0,324	6	1	OE300	39	0		
30 / 70	99,0	29,5	69,5	6	1	00670 01 0	0,339	6	1	OE300	24	0		
35 / 65	99,0	34,5	64,5	6	1	00670 01 0	0,339	6	1	OE300	22	0		
40 / 60	99,0	39,5	59,5	6	1	00670 01 0	0,339	6	1	OE300	25	0		
45 / 55	99,0	44,5	54,5	6	1	00670 01 0	0,339	6	1	OE300	43	0		
50 / 50	99,0	49,5	49,5	6	1	00670 01 0	0,339	6	1	OE300	23	0		
50 / 55	104,0	49,5	54,5	6	1	00670 01 0	0,368	6	1	OE300	64	0		
30 / 75	104,0	29,5	74,5	6	1	00670 01 0	0,339	6	1	OE300	56	0		
35 / 70	104,0	34,5	69,5	6	1	00670 01 0	0,353	6	1	OE300	49	0		
40 / 65	104,0	39,5	64,5	6	1	00670 01 0	0,353	6	1	OE300	44	0		
45 / 60	104,0	44,5	59,5	6	1	00670 01 0	0,353	6	1	OE300	54	0		
45 / 65	109,0	44,5	64,5	6	1	00670 01 0	0,291	6	1	OE300	45	0		
30 / 80	109,0	29,5	79,5	6	1	00670 01 0	0,368	6	1	OE300	37	0		
40 / 70	109,0	39,5	69,5	6	1	00670 01 0	0,368	6	1	OE300	35	0		
50 / 60	109,0	49,5	59,5	6	1	00670 01 0	0,368	6	1	OE300	36	0		
55 / 55	109,0	54,5	54,5	6	1	00670 01 0	0,368	6	1	OE300	70	0		
45 / 70	114,0	44,5	69,5	6	1	00670 01 0	0,390	6	1	OE300	61	0		
45 / 75	119,0	44,5	74,5	6	1	00670 01 0	0,353	6	1	OE300	62	0		
60 / 60	119,0	59,5	59,5	6	1	00670 01 0	0,368	6	1	OE300	40	0		

Type	Description	Comm. dim.					Key item	Kg	Pcs	ITEM				
		L	A	B	Pin	Unit weight				Type	Dim.	Hand	Fin.	Pers.

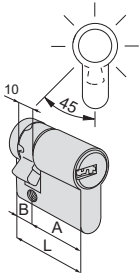

- Single cylinder with 8 position adjustable cam
- Item 1.0E304.18.0 fixed 27° protruding cam

25 / 10	34,5	24,5	10,0	5	1 00670 01 0	0,164	6	1	0E304	18	0			
30 / 10	39,5	29,5	10,0	6	1 00670 01 0	0,164	6	1	0E304	02	0			
35 / 10	44,5	34,5	10,0	6	1 00670 01 0	0,179	6	1	0E304	07	0			
37 / 10	46,5	36,5	10,0	6	1 00670 01 0	0,185	6	1	0E304	10	0			
40 / 10	49,5	39,5	10,0	6	1 00670 01 0	0,195	6	1	0E304	03	0			
45 / 10	54,5	44,5	10,0	6	1 00670 01 0	0,207	6	1	0E304	08	0			
50 / 10	59,5	49,5	10,0	6	1 00670 01 0	0,222	6	1	0E304	04	0			
60 / 10	69,5	59,5	10,0	6	1 00670 01 0	0,252	6	1	0E304	05	0			
65 / 10	74,5	64,5	10,0	6	1 00670 01 0	0,267	6	1	0E304	21	0			
70 / 10	79,5	69,5	10,0	6	1 00670 01 0	0,282	6	1	0E304	06	0			
80 / 10	89,5	79,5	10,0	6	1 00670 01 0	0,312	6	1	0E304	20	0			
90 / 10	103,5	93,5	10,0	6	1 00620 01 0	0,357	6	1	0E304	13	0			

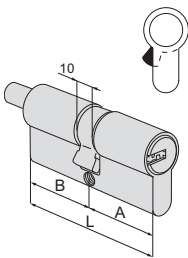

- Double cylinder with thumb turn shaft
- ON REQUEST: Knobs series 06353, 06354, 06355, 06356, 06357

30 / 30	59,0	29,5	29,5	6	1 00670 01 0	0,239	6	1	0E302	07	0			
30 / 35	64,0	29,5	34,5	6	1 00670 01 0	0,254	6	1	0E302	26	0			
35 / 30	64,0	34,5	29,5	6	1 00670 01 0	0,254	6	1	0E302	81	0			
30 / 40	69,0	29,5	39,5	6	1 00670 01 0	0,274	6	1	0E302	82	0			
35 / 35	69,0	34,5	34,5	6	1 00670 01 0	0,265	6	1	0E302	13	0			
40 / 30	69,0	39,5	29,5	6	1 00670 01 0	0,274	6	1	0E302	12	0			
35 / 40	74,0	34,5	39,5	6	1 00670 01 0	0,289	6	1	0E302	28	0			
30 / 50	79,0	29,5	49,5	6	1 00670 01 0	0,304	6	1	0E302	17	0			
35 / 45	79,0	34,5	44,5	6	1 00670 01 0	0,304	6	1	0E302	19	0			
40 / 40	79,0	39,5	39,5	6	1 00670 01 0	0,304	6	1	0E302	18	0			
40 / 45	84,0	39,5	44,5	6	1 00670 01 0	0,319	6	1	0E302	30	0			
45 / 40	84,0	44,5	39,5	6	1 00670 01 0	0,319	6	1	0E302	84	0			
43 / 43	85,0	42,5	42,5	6	1 00670 01 0	0,321	6	1	0E302	46	0			
30 / 60	89,0	29,5	59,5	6	1 00670 01 0	0,334	6	1	0E302	20	0			
45 / 45	89,0	44,5	44,5	6	1 00620 01 0	0,334	6	1	0E302	29	0			
40 / 50	89,0	39,5	49,5	6	1 00670 01 0	0,334	6	1	0E302	21	0			
40 / 55	94,0	39,5	54,5	6	1 00670 01 0	0,355	6	1	0E302	42	0			
45 / 50	94,0	44,5	49,5	6	1 00670 01 0	0,355	6	1	0E302	39	0			
45 / 55	99,0	44,5	54,5	6	1 00670 01 0	0,365	6	1	0E302	43	0			
50 / 50	99,0	49,5	49,5	6	1 00670 01 0	0,365	6	1	0E302	23	0			
45 / 60	104,0	44,5	59,5	6	1 00670 01 0	0,379	6	1	0E302	54	0			
55 / 50	104,0	54,5	49,5	6	1 00670 01 0	0,379	6	1	0E302	64	0			
50 / 60	109,0	49,5	59,5	6	1 00620 01 0	0,395	6	1	0E302	36	0			
60 / 60	119,0	59,5	59,5	6	1 00670 01 0	0,425	6	1	0E302	40	0			

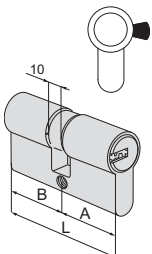

- Nickel-plated double cylinder series with special cam 90° for series 46305 locks
- 3 keys
- Fixing screw

30 / 30	59,0	29,5	29,5	6	1 00670 01 0	0,225	6	1	0E303	07	0	12		
---------	------	------	------	---	--------------	-------	---	---	-------	----	---	----	--	--

Type	Description	Comm. dim.					Key item	Kg	Unit weight	Pieces	ITEM			
		L	A	B	Pins	Type					Dim.	Hand	Fin.	Pers. Spec.

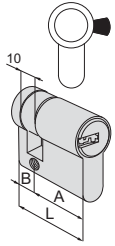

- Nickel-plated single cylinder series with special cam 90° for series 46305 locks
- 3 keys
- Fixing screw

30 / 10	39,5	29,5	10,0	6	1	00670 01 0	0,164	6	1	0E305 02 0 12
----------------	------	------	------	---	---	------------	-------	---	---	----------------------

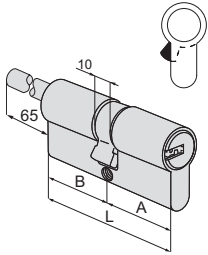

- Double cylinder with adjustable thumb turn shaft
- To be combined with inside rose item 1.06458.20
- ON REQUEST:
Knobs series
06353, 06355,
06356, 06357

30 / 30	59,0	29,5	29,5	6	1	00670 01 0	0,284	6	1	0E307 07 0
40 / 30	69,0	39,5	29,5	6	1	00670 01 0	0,312	6	1	0E307 12 0
35 / 30	64,0	34,5	29,5	6	1	00670 01 0	0,294	6	1	0E307 81 0
45 / 30	74,0	44,5	29,5	6	1	00670 01 0	0,320	6	1	0E307 91 0
50 / 30	79,0	49,5	29,5	6	1	00670 01 0	0,329	6	1	0E307 90 0
60 / 30	89,0	59,5	29,5	6	1	00670 01 0	0,359	6	1	0E307 87 0
70 / 30	99,0	69,5	29,5	6	1	00670 01 0	0,370	6	1	0E307 88 0



Technical features:

- brass body
- brass plugs
- pins:
 - in hardened steel
- drivers:
 - in brass, mushroom-type anti-picking and cylindrical
 - in hardened steel in first position
- phosphor bronze springs
- KEY:
 - flat reversible keys
 - in nickel-plated brass
 - numerical coding on the head

Supplied as standard:

- 3 keys
- Fixing screws

Finishes:

- STANDARD:
 - sanded brass (fin. 00)
- ON REQUEST:
 - nickel-plated brass (fin. 12)

Asix

Type	Description	For locks series	L	Pins	Key item	Unit weight 	Pieces 	ITEM			
								Type	Dim.	Hand	Spec.
	<ul style="list-style-type: none"> • Rim cylinder 	1A610	6	1	1 00670 01 0	0,182	6	1	OE500	00	0
	<ul style="list-style-type: none"> • Round cylinder • For further length see item 07165 	1A611	50,0	6	1 00670 01 0	0,170	6	1	OE200	50	0
	<ul style="list-style-type: none"> • Cylinder set, with round external cylinder 	11721, 11921	50,0	6	1 00670 01 0	0,255	6	1	OE149	00	0
	<ul style="list-style-type: none"> • Cylinder set 	1A630	6	1	1 00670 01 0	0,250	6	1	OE115	00	0
	<ul style="list-style-type: none"> • Cylinder set, with round external cylinder 	1A631, 1A721, 1A731	55,0	6	1 00670 01 0	0,255	6	1	OE150	00	0

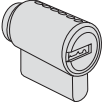
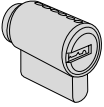
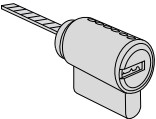
Type	Description	For locks series	Key item		Unit weight	Pieces	ITEM							
			L	Pins			Type	Dim.	Hand	Fin.	Pers.	Spec.		
	<ul style="list-style-type: none"> • Cylinder for padlocks series 28000 • 2 keys 		6	1 00670 01 0	0,117	6	1	0E600	00	0				
	<ul style="list-style-type: none"> • Cylinder for external control item 1.07078.28.0 • Ground brass 		6	1 00670 01 0	0,117	6	1	0E600	10	0				
	<ul style="list-style-type: none"> • Cylinder for external control item 1.07078.29.0 • Ground brass 		6	1 00670 01 0	0,117	6	1	0E600	11	0				



Technical features:

- **CYLINDER:**
- BKP resistance to pumping, patented system
- Security Card: protected key duplication
- Brass body with dual-material **SNAP RESISTANT** core
- Brass plugs
- Carbonitrided steel pins
- Variable shape hardened steel drivers
- Phosphor bronze and steel springs
- Clutch-type DIN cam in self-lubricating sintered steel

KEY:

- protected by trademark
- paracentral keyway
- in nickel silver alloy

- long neck, compatible with protective roses
- numerical code on key bow

Supplied as standard:

- 3 keys
- Security Card
- Fixing screws
- Operating and maintenance instructions

Finishes:

SUPPLIED AS STANDARD:

- nickel-plated sanded brass (fin. 12)

ON REQUEST:

- sanded brass (fin. 00)

Standards:

- In compliance with EN 1303:2015
- Attack Resistance: grade D
- Key Related Security: grade 6
- Durability: grade 6

Certificates:

- SKG***
- ICM

Patents:

- Key: 3D Trade Mark 1 236 248 and Community Design registered at no. 2669630
- BKP: PCT/WO2007/074163 A1

C3000 S

Type	Description	Comm. dim.	Key item			Kg	Pieces	ITEM			
			L	A	B			Pins	Type	Dim.	Hand

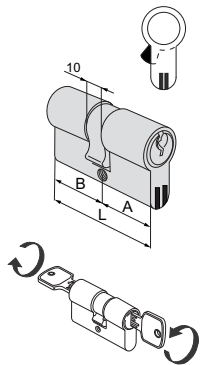

- Double cylinder with clutch system

30 / 30	59,0	29,5	29,5	6	1	00430 00 1	0,235	1	1	ON3S1	07	0	12
30 / 35	64,0	29,5	34,5	6	1	00430 00 1	0,235	1	1	ON3S1	26	0	12
35 / 35	69,0	34,5	34,5	6	1	00430 00 1	0,235	1	1	ON3S1	13	0	12
40 / 30	69,0	39,5	29,5	6	1	00430 00 1	0,235	1	1	ON3S1	12	0	12
30 / 45	74,0	29,5	44,5	6	1	00430 00 1	0,235	1	1	ON3S1	27	0	12
35 / 40	74,0	34,5	39,5	6	1	00430 00 1	0,235	1	1	ON3S1	28	0	12
30 / 50	79,0	29,5	49,5	6	1	00430 00 1	0,235	1	1	ON3S1	17	0	12
35 / 45	79,0	34,5	44,5	6	1	00430 00 1	0,235	1	1	ON3S1	19	0	12
40 / 40	79,0	39,5	39,5	6	1	00430 00 1	0,235	1	1	ON3S1	18	0	12
30 / 55	84,0	29,5	54,5	6	1	00430 00 1	0,235	1	1	ON3S1	33	0	12
35 / 50	84,0	34,5	49,5	6	1	00430 00 1	0,235	1	1	ON3S1	31	0	12
40 / 45	84,0	39,5	44,5	6	1	00430 00 1	0,235	1	1	ON3S1	30	0	12
30 / 60	89,0	29,5	59,5	6	1	00430 00 1	0,235	1	1	ON3S1	20	0	12
35 / 55	89,0	34,5	54,5	6	1	00430 00 1	0,235	1	1	ON3S1	32	0	12
40 / 50	89,0	39,5	49,5	6	1	00430 00 1	0,235	1	1	ON3S1	21	0	12
45 / 45	89,0	44,5	44,5	6	1	00430 00 1	0,235	1	1	ON3S1	29	0	12
30 / 65	94,0	29,5	64,5	6	1	00430 00 1	0,235	1	1	ON3S1	41	0	12
35 / 60	94,0	34,5	59,5	6	1	00430 00 1	0,235	1	1	ON3S1	38	0	12
40 / 55	94,0	39,5	54,5	6	1	00430 00 1	0,235	1	1	ON3S1	42	0	12
45 / 50	94,0	44,5	49,5	6	1	00430 00 1	0,235	1	1	ON3S1	39	0	12
30 / 70	99,0	29,5	69,5	6	1	00430 00 1	0,235	1	1	ON3S1	24	0	12
35 / 65	99,0	34,5	64,5	6	1	00430 00 1	0,235	1	1	ON3S1	22	0	12
40 / 60	99,0	39,5	59,5	6	1	00430 00 1	0,235	1	1	ON3S1	25	0	12
45 / 55	99,0	44,5	54,5	6	1	00430 00 1	0,235	1	1	ON3S1	43	0	12
30 / 30	59,0	29,5	29,5	6	1	00430 00 1	0,235	1	1	ON3S1	23	0	12
40 / 65	104,0	39,5	64,5	6	1	00430 00 1	0,235	1	1	ON3S1	44	0	12
45 / 60	104,0	44,5	59,5	6	1	00430 00 1	0,235	1	1	ON3S1	54	0	12
30 / 75	104,0	29,5	74,5	6	1	00430 00 1	0,235	1	1	ON3S1	56	0	12
55 / 50	104,0	54,5	49,5	6	1	00430 00 1	0,235	1	1	ON3S1	64	0	12
35 / 70	104,0	34,5	69,5	6	1	00430 00 1	0,235	1	1	ON3S1	49	0	12
35 / 75	109,0	34,5	74,5	6	1	00430 00 1	0,235	1	1	ON3S1	57	0	12
30 / 80	109,0	29,5	79,5	6	1	00430 00 1	0,235	1	1	ON3S1	37	0	12
40 / 70	109,0	39,5	69,5	6	1	00430 00 1	0,235	1	1	ON3S1	35	0	12
50 / 60	109,0	49,5	59,5	6	1	00430 00 1	0,235	1	1	ON3S1	36	0	12
55 / 55	109,0	54,5	54,5	6	1	00430 00 1	0,235	1	1	ON3S1	70	0	12
30 / 85	114,0	29,5	84,5	6	1	00430 00 1	0,235	1	1	ON3S1	77	0	12
50 / 65	114,0	49,5	64,5	6	1	00430 00 1	0,235	1	1	ON3S1	65	0	12
55 / 60	114,0	54,5	59,5	6	1	00430 00 1	0,235	1	1	ON3S1	71	0	12
40 / 75	114,0	39,5	74,5	6	1	00430 00 1	0,235	1	1	ON3S1	59	0	12
45 / 70	114,0	44,5	69,5	6	1	00430 00 1	0,235	1	1	ON3S1	61	0	12
30 / 90	119,0	29,5	89,5	6	1	00430 00 1	0,235	1	1	ON3S1	52	0	12
40 / 80	119,0	39,5	79,5	6	1	00430 00 1	0,235	1	1	ON3S1	60	0	12
60 / 60	119,0	59,5	59,5	6	1	00430 00 1	0,235	1	1	ON3S1	40	0	12
50 / 70	119,0	49,5	69,5	6	1	00430 00 1	0,235	1	1	ON3S1	66	0	12
30 / 100	129,0	29,5	99,5	6	1	00430 00 1	0,235	1	1	ON3S1	53	0	12

Type	Description	Comm. dim.				Key item	Kg	Pieces	ITEM			
		L	A	B	pins				Type	Dim.	Hand	Fin.

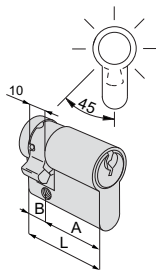

- Single cylinder with 14-position adjustable cam

30 / 10	39,5	29,5	10,0	6	1	00430 00 1	0,186	1	1	ON324 02 0 12
33 / 10	42,5	32,5	10,0	6	1	00430 00 1	0,186	1	1	ON324 09 0 12
35 / 10	44,5	34,5	10,0	6	1	00430 00 1	0,186	1	1	ON324 07 0 12
40 / 10	49,5	39,5	10,0	6	1	00430 00 1	0,186	1	1	ON324 03 0 12
45 / 10	54,5	44,5	10,0	6	1	00430 00 1	0,186	1	1	ON324 08 0 12
50 / 10	59,5	49,5	10,0	6	1	00430 00 1	0,186	1	1	ON324 04 0 12
60 / 10	69,5	59,5	10,0	6	1	00430 00 1	0,186	1	1	ON324 05 0 12
70 / 10	79,5	69,5	10,0	6	1	00430 00 1	0,186	1	1	ON324 06 0 12

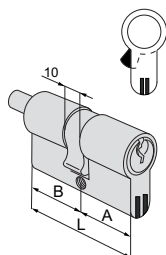

- Double cylinder with adjustable shaft
- ON REQUEST Thumb turns
- 06353, 06355, 06356, 06357 series

30 / 30	59,0	29,5	29,5	6	1	00430 00 1	0,244	1	1	ON352 07 0 12
30 / 35	64,0	29,5	34,5	6	1	00430 00 1	0,244	1	1	ON352 26 0 12
35 / 30	64,0	34,5	29,5	6	1	00430 00 1	0,244	1	1	ON352 81 0 12
33 / 33	65,0	32,5	32,5	6	1	00430 00 1	0,244	1	1	ON352 10 0 12
30 / 40	69,0	29,5	39,5	6	1	00430 00 1	0,244	1	1	ON352 82 0 12
35 / 35	69,0	34,5	34,5	6	1	00430 00 1	0,244	1	1	ON352 13 0 12
40 / 30	69,0	39,5	29,5	6	1	00430 00 1	0,244	1	1	ON352 12 0 12
35 / 40	74,0	34,5	39,5	6	1	00430 00 1	0,244	1	1	ON352 28 0 12
30 / 45	74,0	29,5	44,5	6	1	00430 00 1	0,244	1	1	ON352 27 0 12
40 / 35	74,0	39,5	34,5	6	1	00430 00 1	0,244	1	1	ON352 83 0 12
45 / 30	74,0	44,5	29,5	6	1	00430 00 1	0,244	1	1	ON352 91 0 12
30 / 50	79,0	29,5	49,5	6	1	00430 00 1	0,244	1	1	ON352 17 0 12
35 / 45	79,0	34,5	44,5	6	1	00430 00 1	0,244	1	1	ON352 19 0 12
40 / 40	79,0	39,5	39,5	6	1	00430 00 1	0,244	1	1	ON352 18 0 12
45 / 35	79,0	44,5	34,5	6	1	00430 00 1	0,244	1	1	ON352 85 0 12
40 / 45	84,0	39,5	44,5	6	1	00430 00 1	0,244	1	1	ON352 30 0 12
45 / 40	84,0	44,5	39,5	6	1	00430 00 1	0,244	1	1	ON352 84 0 12
50 / 35	84,0	49,5	34,5	6	1	00430 00 1	0,244	1	1	ON352 94 0 12
30 / 60	89,0	29,5	59,5	6	1	00430 00 1	0,244	1	1	ON352 20 0 12
40 / 50	89,0	39,5	49,5	6	1	00430 00 1	0,244	1	1	ON352 21 0 12
45 / 45	89,0	44,5	44,5	6	1	00430 00 1	0,244	1	1	ON352 29 0 12
40 / 55	94,0	39,5	54,5	6	1	00430 00 1	0,244	1	1	ON352 42 0 12
55 / 40	94,0	54,5	39,5	6	1	00430 00 1	0,244	1	1	ON352 98 0 12
45 / 50	94,0	44,5	49,5	6	1	00430 00 1	0,244	1	1	ON352 39 0 12
40 / 60	99,0	39,5	59,5	6	1	00430 00 1	0,244	1	1	ON352 25 0 12
45 / 55	99,0	44,5	54,5	6	1	00430 00 1	0,244	1	1	ON352 43 0 12
50 / 50	99,0	49,5	49,5	6	1	00430 00 1	0,244	1	1	ON352 23 0 12
55 / 55	104,0	54,5	54,5	6	1	00430 00 1	0,244	1	1	ON352 70 0 12
40 / 65	104,0	39,5	64,5	6	1	00430 00 1	0,244	1	1	ON352 44 0 12
45 / 60	104,0	44,5	59,5	6	1	00430 00 1	0,244	1	1	ON352 54 0 12
55 / 50	104,0	54,5	49,5	6	1	00430 00 1	0,244	1	1	ON352 64 0 12
30 / 80	109,0	29,5	79,5	6	1	00430 00 1	0,244	1	1	ON352 37 0 12
40 / 70	109,0	39,5	69,5	6	1	00430 00 1	0,244	1	1	ON352 35 0 12
50 / 60	109,0	49,5	59,5	6	1	00430 00 1	0,244	1	1	ON352 36 0 12
60 / 50	109,0	59,5	49,5	6	1	00430 00 1	0,244	1	1	ON352 89 0 12
35 / 80	114,0	34,5	79,5	6	1	00430 00 1	0,244	1	1	ON352 58 0 12
55 / 60	114,0	54,5	59,5	6	1	00430 00 1	0,244	1	1	ON352 71 0 12
45 / 70	114,0	44,5	69,5	6	1	00430 00 1	0,244	1	1	ON352 61 0 12
50 / 65	114,0	49,5	64,5	6	1	00430 00 1	0,244	1	1	ON352 65 0 12
55 / 65	119,0	54,5	64,5	6	1	00430 00 1	0,244	1	1	ON352 72 0 12
65 / 55	119,0	64,5	54,5	6	1	00430 00 1	0,244	1	1	ON352 86 0 12
60 / 60	119,0	59,5	59,5	6	1	00430 00 1	0,244	1	1	ON352 40 0 12

Type	Description	Comm. dim.				Key item	Unit weight Kg	Pieces	ITEM					
		L	A	B	Plms				Type	Dim.	Hand	Fin.	Pers. Spec.	
<ul style="list-style-type: none"> • Double cylinder with adjustable shaft, pre-set for thumb turn • To use with inside escutcheon item 1.06458.20 • On request: Thumb turns item 06353, 06355, 06356, 06357 	30 / 30	59,0	29,5	29,5	6	1 00430 00 1	0,275	1	1	ON3S7 07 0 12				
	35 / 30	64,0	34,5	29,5	6	1 00430 00 1	0,275	1	1	ON3S7 81 0 12				
	40 / 30	69,0	39,5	29,5	6	1 00430 00 1	0,275	1	1	ON3S7 12 0 12				
	45 / 30	74,0	44,5	29,5	6	1 00430 00 1	0,275	1	1	ON3S7 91 0 12				
	50 / 30	79,0	49,5	29,5	6	1 00430 00 1	0,275	1	1	ON3S7 90 0 12				
	55 / 30	84,0	54,5	29,5	6	1 00430 00 1	0,275	1	1	ON3S7 92 0 12				
	60 / 30	89,0	59,5	29,5	6	1 00430 00 1	0,275	1	1	ON3S7 87 0 12				
	65 / 30	94,0	64,5	29,5	6	1 00430 00 1	0,275	1	1	ON3S7 A3 0 12				
	70 / 30	99,0	69,5	29,5	6	1 00430 00 1	0,275	1	1	ON3S7 88 0 12				
	80 / 30	110,0	79,5	29,5	6	1 00430 00 1	0,275	1	1	ON3S7 93 0 12				
	90 / 30	120,0	89,5	29,5	6	1 00430 00 1	0,275	1	1	ON3S7 C6 0 12				
100 / 30	130,0	99,5	29,5	6	1 00430 00 1	0,275	1	1	ON3S7 C7 0 12					



Technical features:

- CYLINDER :**
- BKP resistance to pumping, patented system
 - Security Card: protected key duplication
 - Brass plugs
 - Carbonitrided steel pins
 - Variable shape hardened steel drivers
 - Phosphor bronze and steel springs
 - DIN cam in self-lubricating sintered steel

KEY:

- protected by trademark
- paracentral keyway
- in nickel silver alloy
- long neck, compatible with protective roses
- numerical code on key bow

Supplied as standard:

- 3 keys
- Security Card
- Fixing screws
- Operating and maintenance instructions

Finishes:

- **SUPPLIED AS STANDARD:**
 - nickel-plated sanded brass (fin. 12)
- **ON REQUEST:**
 - sanded brass (fin. 00)

Standards:

- In compliance with EN 1303:2015
- Attack Resistance: grade A
- Key Related Security: grade 6
- Durability: grade 6

Certificates:

SKG**

Patents:

- Key: 3D Trade Mark 1 236 248 and Community Design registered at no. 2669630
- BKP: PCT/WO2007/074163 A1

C3000

Type	Description	Comm. dim.	Key item			Kg	Pieces	ITEM			
			L	A	B			Pins	Type	Dim.	Hand

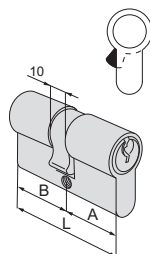

• Double cylinder

30 / 30	59,0	29,5	29,5	6	1	00430 00 1	0,235	12	1	ON310 07 0 12
30 / 35	64,0	29,5	34,5	6	1	00430 00 1	0,238	12	1	ON310 26 0 12
33 / 33	65,0	32,5	32,5	6	1	00430 00 1	0,238	12	1	ON310 10 0 12
35 / 35	69,0	34,5	34,5	6	1	00430 00 1	0,272	12	1	ON310 13 0 12
40 / 30	69,0	39,5	29,5	6	1	00430 00 1	0,272	12	1	ON310 12 0 12
30 / 45	74,0	29,5	44,5	6	1	00430 00 1	0,274	12	1	ON310 27 0 12
35 / 40	74,0	34,5	39,5	6	1	00430 00 1	0,274	12	1	ON310 28 0 12
30 / 50	79,0	29,5	49,5	6	1	00430 00 1	0,289	12	1	ON310 17 0 12
35 / 45	79,0	34,5	44,5	6	1	00430 00 1	0,289	12	1	ON310 19 0 12
40 / 40	79,0	39,5	39,5	6	1	00430 00 1	0,289	12	1	ON310 18 0 12
30 / 55	84,0	29,5	54,5	6	1	00430 00 1	0,304	12	1	ON310 33 0 12
35 / 50	84,0	34,5	49,5	6	1	00430 00 1	0,304	12	1	ON310 31 0 12
40 / 45	84,0	39,5	44,5	6	1	00430 00 1	0,304	12	1	ON310 30 0 12
30 / 60	89,0	29,5	59,5	6	1	00430 00 1	0,320	12	1	ON310 20 0 12
35 / 55	89,0	34,5	54,5	6	1	00430 00 1	0,320	12	1	ON310 32 0 12
40 / 50	89,0	39,5	49,5	6	1	00430 00 1	0,320	12	1	ON310 21 0 12
45 / 45	89,0	44,5	44,5	6	1	00430 00 1	0,320	12	1	ON310 29 0 12
30 / 65	94,0	29,5	64,5	6	1	00430 00 1	0,330	6	1	ON310 41 0 12
35 / 60	94,0	34,5	59,5	6	1	00430 00 1	0,330	6	1	ON310 38 0 12
40 / 55	94,0	39,5	54,5	6	1	00430 00 1	0,330	6	1	ON310 42 0 12
45 / 50	94,0	44,5	49,5	6	1	00430 00 1	0,330	6	1	ON310 39 0 12
30 / 70	99,0	29,5	69,5	6	1	00430 00 1	0,340	6	1	ON310 24 0 12
35 / 65	99,0	34,5	64,5	6	1	00430 00 1	0,340	6	1	ON310 22 0 12
40 / 60	99,0	39,5	59,5	6	1	00430 00 1	0,340	6	1	ON310 25 0 12
45 / 55	99,0	44,5	54,5	6	1	00430 00 1	0,349	6	1	ON310 43 0 12
50 / 50	99,0	49,5	49,5	6	1	00430 00 1	0,340	6	1	ON310 23 0 12
30 / 75	104,0	29,5	74,5	6	1	00430 00 1	0,340	6	1	ON310 56 0 12
35 / 70	104,0	34,5	69,5	6	1	00430 00 1	0,340	6	1	ON310 49 0 12
55 / 50	104,0	54,5	49,5	6	1	00430 00 1	0,340	6	1	ON310 64 0 12
40 / 65	104,0	39,5	64,5	6	1	00430 00 1	0,235	6	1	ON310 44 0 12
45 / 60	104,0	44,5	59,5	6	1	00430 00 1	0,235	6	1	ON310 54 0 12
30 / 80	109,0	29,5	79,5	6	1	00430 00 1	0,360	6	1	ON310 37 0 12
40 / 70	109,0	39,5	69,5	6	1	00430 00 1	0,360	6	1	ON310 35 0 12
50 / 60	109,0	49,5	59,5	6	1	00430 00 1	0,360	6	1	ON310 36 0 12
55 / 55	109,0	54,5	54,5	6	1	00430 00 1	0,360	6	1	ON310 70 0 12
35 / 75	109,0	34,5	74,5	6	1	00430 00 1	0,235	6	1	ON310 57 0 12
45 / 65	109,0	44,5	64,5	6	1	00430 00 1	0,289	6	1	ON310 45 0 12
50 / 65	114,0	49,5	64,5	6	1	00430 00 1	0,370	6	1	ON310 65 0 12
55 / 60	114,0	54,5	59,5	6	1	00430 00 1	0,370	6	1	ON310 71 0 12
40 / 75	114,0	39,5	74,5	6	1	00430 00 1	0,370	6	1	ON310 59 0 12
45 / 75	114,0	44,5	74,5	6	1	00430 00 1	0,289	6	1	ON310 61 0 12
30 / 85	114,0	29,5	84,5	6	1	00430 00 1	0,235	6	1	ON310 77 0 12
30 / 90	119,0	29,5	89,5	6	1	00430 00 1	0,410	6	1	ON310 52 0 12
40 / 80	119,0	39,5	79,5	6	1	00430 00 1	0,380	6	1	ON310 60 0 12
45 / 75	119,0	44,5	74,5	6	1	00430 00 1	0,235	6	1	ON310 62 0 12
60 / 60	119,0	59,5	59,5	6	1	00430 00 1	0,380	6	1	ON310 40 0 12

Type	Description	Comm. dim.				Key item	Kg	Pieces	ITEM				
		L	A	B	Pins				Type	Dim.	Hand	Fin.	Pers.

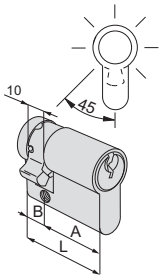

- Single cylinder with 14-position adjustable cam

30 / 10	39,5	29,5	10,0	6	1 00430 00 1	0,186	12	1	ON314 02 0 12
33 / 10	42,5	32,5	10,0	6	1 00430 00 1	0,195	12	1	ON314 09 0 12
35 / 10	44,5	34,5	10,0	6	1 00430 00 1	0,200	12	1	ON314 07 0 12
40 / 10	49,5	39,5	10,0	6	1 00430 00 1	0,210	12	1	ON314 03 0 12
45 / 10	54,5	44,5	10,0	6	1 00430 00 1	0,220	12	1	ON314 08 0 12
50 / 10	59,5	49,5	10,0	6	1 00430 00 1	0,225	12	1	ON314 04 0 12
60 / 10	69,5	59,5	10,0	6	1 00430 00 1	0,235	12	1	ON314 05 0 12
70 / 10	79,5	69,5	10,0	6	1 00430 00 1	0,245	12	1	ON314 06 0 12

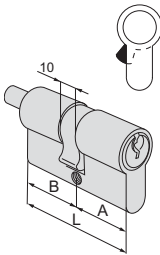

- Double cylinder pre-set for thumb turn installation
- On request: thumb turns series: 06353, 06355, 06356, 06357

30 / 30	59,0	29,5	29,5	6	1 00430 00 1	0,244	12	1	ON312 07 0 12
30 / 35	64,0	29,5	34,5	6	1 00430 00 1	0,259	12	1	ON312 26 0 12
35 / 30	64,0	34,5	29,5	6	1 00430 00 1	0,259	12	1	ON312 81 0 12
33 / 33	65,0	32,5	32,5	6	1 00430 00 1	0,259	12	1	ON312 10 0 12
30 / 40	69,0	29,5	39,5	6	1 00430 00 1	0,279	12	1	ON312 82 0 12
35 / 35	69,0	34,5	34,5	6	1 00430 00 1	0,279	12	1	ON312 13 0 12
40 / 30	69,0	39,5	29,5	6	1 00430 00 1	0,279	12	1	ON312 12 0 12
35 / 40	74,0	34,5	39,5	6	1 00430 00 1	0,294	12	1	ON312 28 0 12
30 / 45	74,0	29,5	44,5	6	1 00430 00 1	0,294	12	1	ON312 27 0 12
40 / 35	74,0	39,5	34,5	6	1 00430 00 1	0,294	12	1	ON312 83 0 12
45 / 30	74,0	44,5	29,5	6	1 00430 00 1	0,294	12	1	ON312 91 0 12
30 / 50	79,0	29,5	49,5	6	1 00430 00 1	0,309	6	1	ON312 17 0 12
35 / 45	79,0	34,5	44,5	6	1 00430 00 1	0,309	6	1	ON312 19 0 12
40 / 40	79,0	39,5	39,5	6	1 00430 00 1	0,309	6	1	ON312 18 0 12
45 / 35	79,0	44,5	34,5	6	1 00430 00 1	0,309	6	1	ON312 85 0 12
40 / 45	84,0	39,5	44,5	6	1 00430 00 1	0,324	6	1	ON312 30 0 12
45 / 40	84,0	44,5	39,5	6	1 00430 00 1	0,324	6	1	ON312 84 0 12
30 / 60	89,0	29,5	59,5	6	1 00430 00 1	0,344	6	1	ON312 20 0 12
40 / 50	89,0	39,5	49,5	6	1 00430 00 1	0,344	6	1	ON312 21 0 12
45 / 45	89,0	44,5	44,5	6	1 00430 00 1	0,344	6	1	ON312 29 0 12
40 / 55	94,0	39,5	54,5	6	1 00430 00 1	0,364	6	1	ON312 42 0 12
55 / 40	94,0	54,5	39,5	6	1 00430 00 1	0,364	6	1	ON312 98 0 12
45 / 50	94,0	44,5	49,5	6	1 00430 00 1	0,364	6	1	ON312 39 0 12
40 / 60	99,0	39,5	59,5	6	1 00430 00 1	0,384	6	1	ON312 25 0 12
45 / 55	99,0	44,5	54,5	6	1 00430 00 1	0,384	6	1	ON312 43 0 12
50 / 50	99,0	49,5	49,5	6	1 00430 00 1	0,384	6	1	ON312 23 0 12
45 / 60	104,0	44,5	59,5	6	1 00430 00 1	0,394	6	1	ON312 54 0 12
55 / 50	104,0	54,5	49,5	6	1 00430 00 1	0,394	6	1	ON312 64 0 12
30 / 80	109,0	29,5	79,5	6	1 00430 00 1	0,410	6	1	ON312 37 0 12
40 / 70	109,0	39,5	69,5	6	1 00430 00 1	0,410	6	1	ON312 35 0 12
50 / 60	109,0	49,5	59,5	6	1 00430 00 1	0,410	6	1	ON312 36 0 12

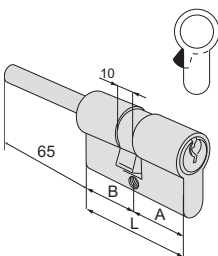

- Double cylinder with adjustable shaft, pre-set for thumb turn
- To use with inside escutcheon item 1.06458.20
- On request: thumb turns series: 06353, 06355, 06356, 06357

30 / 30	59,0	29,5	29,5	6	1 00430 00 1	0,275	6	1	ON317 07 0 12
35 / 30	64,0	34,5	29,5	6	1 00430 00 1	0,285	6	1	ON317 81 0 12
40 / 30	69,0	39,5	29,5	6	1 00430 00 1	0,295	6	1	ON317 12 0 12
45 / 30	74,0	44,5	29,5	6	1 00430 00 1	0,305	6	1	ON317 91 0 12
50 / 30	79,0	49,5	29,5	6	1 00430 00 1	0,315	6	1	ON317 90 0 12
55 / 30	84,0	54,5	29,5	6	1 00430 00 1	0,325	6	1	ON317 92 0 12
60 / 30	89,0	59,5	29,5	6	1 00430 00 1	0,335	6	1	ON317 87 0 12
65 / 30	94,0	64,5	29,5	6	1 00430 00 1	0,345	6	1	ON317 A3 0 12
70 / 30	99,0	69,5	29,5	6	1 00430 00 1	0,355	6	1	ON317 88 0 12
80 / 30	110,0	79,5	29,5	6	1 00430 00 1	0,375	1	1	ON317 93 0 12



Technical features:

- CYLINDER:**
- Security Card: protected key duplication
 - Brass plugs
 - Carbonitrided steel pins
 - Variable shape hardened steel drivers
 - Phosphor bronze and steel springs

- KEY:**
- protected by trademark
 - paracentral keyway
 - in nickel silver alloy
 - long neck, compatible with protective roses
 - numerical code on key bow

Supplied as standard:

- 3 keys
- Security Card
- Fixing screws
- Operating and maintenance instructions

Finishes:

- **SUPPLIED AS STANDARD:**
 - nickel-plated sanded brass (fin. 12)
- **ON REQUEST:**
 - polished brass (fin. 66)

Patents:

- Key: 3D Trade Mark 1 236 248 and Community Design registered at no. 2669630

C3000

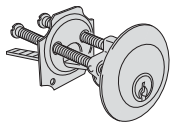
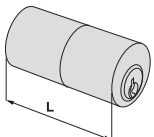
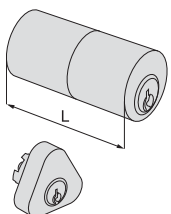
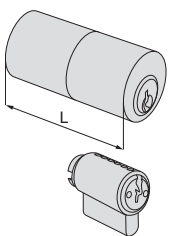
Type	Description	For locks series	Key item		Unit weight	Pieces	ITEM								
			L	Pins			Kg	Type	Dim.	Hand	Fin.	Pers. Spec.			
	• Cylinder	1A610, 11610, 50010, 50130, 50180, 50330, 54310, 54315, 54340, 54510, 54550, 54570	6	1 00430 00 1	0,204	6	1	ON510	00	0	12				
	• Tubular cylinder	1A611, 11611, 50111, 50131, 50181, 50481, 54316, 54341	55,0	6 1 00430 00 1	0,160	6	1	ON210	55	0	12				
	• Pair of cylinders with external tubular cylinder	50121, 50126, 50141, 50161, 50171, 50211, 50211, 50221, 50421, 50451, 50471, 50521, 50571 11721, 11921	50,0	6 1 00430 00 1	0,267	6	1	ON116	00	0	12				
	• Pair of cylinders with external tubular cylinder	1A631, 1A721, 1A731	55,0	6 1 00430 00 1	0,267	6	1	ON150	00	0	12				



Technical features:

- CYLINDER**
- CISA patented system
 - Security Card: protected key duplication
 - Brass body
 - Brass plugs
 - Carbonitrided steel pins
 - Variable shape hardened steel drivers
 - Phosphor bronze and steel springs

KEY:

- protected by trademark
- paracentral keyway
- in nickel silver alloy
- long neck, compatible with protective roses
- numerical code on key bow

Supplied as standard:

- 3 keys
- Security Card
- Fixing screws
- Operating and maintenance instructions

Finishes:

- SUPPLIED AS STANDARD:
- nickel-plated sanded brass (fin. 12)

Patents:

- Key: 3D Trade Mark 1 236 248 and Community Design registered at no. 2669630

C3000

Type	Description	For locks series	L	Pins	Key item	Kg	Pieces	ITEM			
								Type	Dim.	Hand	Fin.

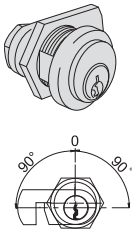

- Key extraction to position (0)
- Deadbolt item 1.06414.20.0 or 1.06414.30.0 (to be ordered separately)

17 6 1 00430 00 1 0,150 6 1 **0N410 00 0 12**

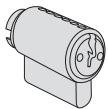

- Steel padlock plug
- 2 keys
- Pickled brass body
- Complete with plate item 1.07573.08.0

6 1 00430 00 1 0,106 6 1 **0N610 00 0**



Technical features:

- brass body
- brass plugs
- self-lubricating sintered steel projecting cam, DIN-compatible
- pins:
 - in hardened steel
- drivers:
 - in brass
 - in hardened steel in first position
- phosphor bronze springs
- KEY:
- nickel-plated brass
- long key for protective roses compatibility
- Numerical code on paracentral key bow

Supplied as standard:

- 3 keys
- Fixing screw

Finishes:

- STANDARD:
 - sanded brass (fin. 00)
- ON REQUEST:
 - nickel-plated brass (fin. 12)
 - polished brass (66)

Standards:

- Compliant with EN 1303:2015
- Attack Resistance: grade 0
- Key Related Security: grade 4
- Durability: grade 6

EN 1303:15	KEY RELATED SECURITY	1	2	3	4	5	6
	ATTACK RESISTANCE	0	A	B	C	D	
	DURABILITY	1	2	3	4	5	6

C2000

Type	Description	Comm. dim.	Key item				Kg	Pieces	ITEM			
			L	A	B	Pins			Type	Dim.	Hand	Fin.

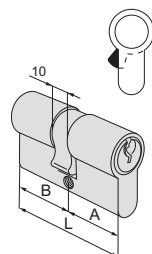

• Double cylinder

22 / 22	43,4	21,7	21,7	3	1	01070 01 1	0,172	12	1	0G300 02 0
22 / 27	48,4	21,7	26,7	3	1	01070 01 1	0,192	12	1	0G300 03 0
25 / 25	49,8	24,9	24,9	4	1	01070 05 1	0,189	12	1	0G300 04 0
27 / 27	53,0	26,5	26,5	4	1	01070 05 1	0,200	12	1	0G300 05 0
27 / 33	59,0	26,5	32,5	4	1	01070 05 1	0,216	12	1	0G300 06 0
30 / 30	59,0	29,5	29,5	5	1	01070 10 1	0,216	12	1	0G300 07 0
30 / 33	62,0	29,5	32,5	5	1	01070 10 1	0,212	12	1	0G300 08 0
27 / 37	63,0	26,5	36,5	4	1	01070 05 1	0,237	12	1	0G300 09 0
30 / 35	64,0	29,5	34,5	5	1	01070 10 1	0,233	12	1	0G300 26 0
33 / 33	65,0	32,5	32,5	5	1	01070 10 1	0,233	12	1	0G300 10 0
27 / 43	69,0	26,5	42,5	4	1	01070 05 1	0,250	12	1	0G300 11 0
30 / 40	69,0	29,5	39,5	5	1	01070 10 1	0,250	12	1	0G300 12 0
35 / 35	69,0	34,5	34,5	5	1	01070 10 1	0,250	12	1	0G300 13 0
30 / 43	72,0	29,5	42,5	5	1	01070 10 1	0,258	6	1	0G300 14 0
37 / 37	73,0	36,5	36,5	5	1	01070 10 1	0,266	6	1	0G300 15 0
30 / 45	74,0	29,5	44,5	5	1	01070 10 1	0,266	6	1	0G300 27 0
35 / 40	74,0	34,5	39,5	5	1	01070 10 1	0,266	6	1	0G300 28 0
27 / 53	79,0	26,5	52,5	4	1	01070 05 1	0,283	6	1	0G300 16 0
30 / 50	79,0	29,5	49,5	5	1	01070 10 1	0,291	6	1	0G300 17 0
35 / 45	79,0	34,5	44,5	5	1	01070 10 1	0,283	6	1	0G300 19 0
40 / 40	79,0	39,5	39,5	5	1	01070 10 1	0,285	6	1	0G300 18 0
30 / 55	84,0	29,5	54,5	5	1	01070 10 1	0,300	6	1	0G300 33 0
35 / 50	84,0	34,5	49,5	5	1	01070 10 1	0,300	6	1	0G300 31 0
40 / 45	84,0	39,5	44,5	5	1	01070 10 1	0,300	6	1	0G300 30 0
43 / 43	85,0	42,5	42,5	5	1	01070 10 1	0,303	6	1	0G300 46 0
30 / 60	89,0	29,5	59,5	5	1	01070 10 1	0,316	6	1	0G300 20 0
35 / 55	89,0	34,5	54,5	5	1	01070 10 1	0,325	6	1	0G300 32 0
40 / 50	89,0	39,5	49,5	5	1	01070 10 1	0,316	6	1	0G300 21 0
45 / 45	89,0	44,5	44,5	5	1	01070 10 1	0,325	6	1	0G300 29 0
35 / 60	94,0	34,5	59,5	5	1	01070 10 1	0,312	6	1	0G300 38 0
45 / 50	94,0	44,5	49,5	5	1	01070 10 1	0,312	6	1	0G300 39 0
40 / 55	94,0	39,5	54,5	5	1	01070 10 1	0,330	6	1	0G300 42 0
30 / 65	94,0	29,5	64,5	5	1	01070 10 1	0,350	6	1	0G300 41 0
30 / 70	99,0	29,5	69,5	5	1	01070 10 1	0,350	6	1	0G300 24 0
35 / 65	99,0	34,5	64,5	5	1	01070 10 1	0,312	6	1	0G300 22 0
40 / 60	99,0	39,5	59,5	5	1	01070 10 1	0,350	6	1	0G300 25 0
45 / 55	99,0	44,5	54,5	5	1	01070 10 1	0,312	6	1	0G300 43 0
50 / 50	99,0	49,5	49,5	5	1	01070 10 1	0,350	6	1	0G300 23 0
45 / 60	104,0	44,5	59,5	5	1	01070 10 1	0,350	6	1	0G300 54 0
35 / 70	104,0	34,5	69,5	5	1	01070 10 1	0,350	6	1	0G300 49 0
40 / 65	104,0	39,5	64,5	5	1	01070 10 1	0,172	6	1	0G300 44 0
50 / 55	104,0	49,5	54,5	5	1	01070 10 1	0,172	6	1	0G300 64 0
30 / 75	104,0	29,5	74,5	5	1	01070 10 1	0,172	6	1	0G300 56 0
30 / 80	109,0	29,5	79,5	5	1	01070 10 1	0,350	6	1	0G300 37 0
40 / 70	109,0	39,5	69,5	5	1	01070 10 1	0,360	6	1	0G300 35 0
50 / 60	109,0	49,5	59,5	5	1	01070 10 1	0,360	6	1	0G300 36 0
55 / 55	109,0	54,5	54,5	5	1	01070 10 1	0,360	6	1	0G300 70 0
45 / 65	109,0	44,5	64,5	5	1	01070 10 1	0,212	6	1	0G300 45 0

Type	Description	Comm. dim.				Key item	Kg	Pcs	ITEM				
		L	A	B	Pins				Unit weight	Pieces	Type	Dim.	Hand

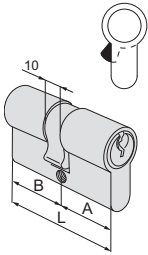

• Double cylinder

35 / 75	109,0	34,5	74,5	5	1 01070 10 1	0,360	6	1	OG300 57 0
35 / 80	114,0	34,5	79,5	5	1 01070 10 1	0,172	6	1	OG300 58 0
40 / 75	114,0	39,5	74,5	5	1 01070 10 1	0,172	6	1	OG300 59 0
45 / 70	114,0	44,5	69,5	5	1 01070 10 1	0,212	6	1	OG300 61 0
50 / 65	114,0	49,5	64,5	5	1 01070 10 1	0,172	6	1	OG300 65 0
30 / 85	114,0	29,5	84,5	5	1 01070 10 1	0,216	6	1	OG300 77 0
60 / 60	119,0	59,5	59,5	5	1 01070 10 1	0,390	6	1	OG300 40 0
30 / 90	119,0	29,5	89,5	5	1 01070 10 1	0,390	6	1	OG300 52 0
40 / 80	119,0	39,5	79,5	5	1 01070 10 1	0,390	6	1	OG300 60 0
50 / 70	119,0	49,5	69,5	5	1 01070 10 1	0,212	6	1	OG300 66 0
45 / 75	119,0	44,5	74,5	5	1 01070 10 1	0,390	6	1	OG300 62 0
70 / 70	139,0	69,5	69,5	5	1 01070 10 1	0,440	6	1	OG300 50 0
30 / 100	129,0	29,5	99,5	5	1 01070 10 1	0,430	6	1	OG300 53 0

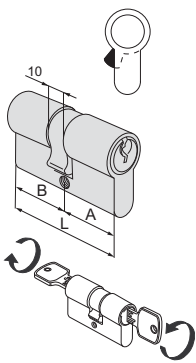

• Clutching system double cylinder

27 / 27	53,0	26,5	26,5	4	1 01070 05 1	0,202	12	1	OG301 05 0
27 / 33	59,0	26,5	32,5	4	1 01070 05 1	0,222	12	1	OG301 06 0
30 / 30	59,0	29,5	29,5	5	1 01070 10 1	0,222	12	1	OG301 07 0
27 / 37	63,0	26,5	36,5	4	1 01070 05 1	0,232	12	1	OG301 09 0
30 / 35	64,0	29,5	34,5	5	1 01070 10 1	0,232	12	1	OG301 26 0
27 / 43	69,0	26,5	42,5	4	1 01070 05 1	0,252	12	1	OG301 11 0
35 / 35	69,0	34,5	34,5	5	1 01070 10 1	0,252	12	1	OG301 13 0
30 / 40	69,0	29,5	39,5	5	1 01070 10 1	0,252	12	1	OG301 12 0
35 / 40	74,0	34,5	39,5	5	1 01070 10 1	0,252	6	1	OG301 28 0
40 / 45	84,0	39,5	44,5	5	1 01070 10 1	0,252	6	1	OG301 30 0

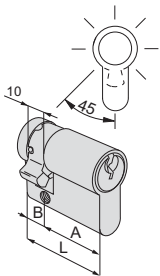

• Single cylinder with adjustable cam in 8 position

25 / 10	34,5	24,5	10,0	4	1 01070 05 1	0,146	12	1	OG304 18 0
30 / 10	39,5	29,5	10,0	5	1 01070 10 1	0,155	12	1	OG304 02 0
33 / 10	42,5	32,5	10,0	5	1 01070 10 1	0,165	12	1	OG304 09 0
35 / 10	44,5	34,5	10,0	5	1 01070 10 1	0,170	12	1	OG304 07 0
37 / 10	46,5	36,5	10,0	5	1 01070 10 1	0,175	12	1	OG304 10 0
40 / 10	49,5	39,5	10,0	5	1 01070 10 1	0,191	12	1	OG304 03 0
43 / 10	52,5	42,5	10,0	5	1 01070 10 1	0,195	12	1	OG304 11 0
50 / 10	59,5	49,5	10,0	5	1 01070 10 1	0,215	12	1	OG304 04 0
55 / 10	64,5	54,5	10,0	5	1 01070 10 1	0,245	12	1	OG304 35 0
60 / 10	69,5	59,5	10,0	5	1 01070 10 1	0,245	12	1	OG304 05 0
64 / 10	73,5	63,5	10,0	5	1 01070 10 1	0,255	6	1	OG304 21 0
70 / 10	79,5	69,5	10,0	5	1 01070 10 1	0,275	6	1	OG304 06 0
80 / 10	89,5	79,5	10,0	5	1 01070 10 1	0,305	6	1	OG304 20 0
94 / 10	103,5	93,5	10,0	5	1 01070 10 1	0,355	6	1	OG304 13 0

Type	Description	Comm. dim.				Key item	Kg	Pieces	ITEM				
		L	A	B	Pins				Type	Dim.	Hand	Fin.	Pers.

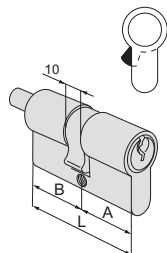

- Double cylinder with thumb turn shaft
- ON REQUEST:
Knobs series 06353, 06355, 06356, 06357

30 / 30	59,0	29,5	29,5	5	1	01070 10 1	0,237	6	1	OG302 07 0
30 / 35	64,0	29,5	34,5	5	1	01070 10 1	0,250	6	1	OG302 26 0
35 / 30	64,0	34,5	29,5	5	1	01070 10 1	0,250	6	1	OG302 81 0
33 / 33	65,0	32,5	32,5	5	1	01070 10 1	0,255	6	1	OG302 10 0
30 / 40	69,0	29,5	39,5	5	1	01070 10 1	0,270	6	1	OG302 82 0
35 / 35	69,0	34,5	34,5	5	1	01070 10 1	0,270	6	1	OG302 13 0
40 / 30	69,0	39,5	29,5	5	1	01070 10 1	0,270	6	1	OG302 12 0
35 / 40	74,0	34,5	39,5	5	1	01070 10 1	0,285	6	1	OG302 28 0
40 / 35	74,0	39,5	34,5	5	1	01070 10 1	0,285	6	1	OG302 83 0
30 / 50	79,0	29,5	49,5	5	1	01070 10 1	0,300	6	1	OG302 17 0
35 / 45	79,0	34,5	44,5	5	1	01070 10 1	0,300	6	1	OG302 19 0
40 / 40	79,0	39,5	39,5	5	1	01070 10 1	0,300	6	1	OG302 18 0
45 / 35	79,0	44,5	34,5	5	1	01070 10 1	0,300	6	1	OG302 85 0
40 / 45	84,0	39,5	44,5	5	1	01070 10 1	0,315	6	1	OG302 30 0
45 / 40	84,0	44,5	39,5	5	1	01070 10 1	0,315	6	1	OG302 84 0
43 / 43	85,0	42,5	42,5	5	1	01070 10 1	0,318	6	1	OG302 46 0
30 / 60	89,0	29,5	59,5	5	1	01070 10 1	0,330	6	1	OG302 20 0
40 / 50	89,0	39,5	49,5	5	1	01070 10 1	0,330	6	1	OG302 21 0
45 / 45	89,0	44,5	44,5	5	1	01070 10 1	0,330	6	1	OG302 29 0
40 / 55	94,0	39,5	54,5	5	1	01070 10 1	0,350	6	1	OG302 42 0
45 / 50	94,0	44,5	49,5	5	1	01070 10 1	0,350	6	1	OG302 39 0
45 / 55	99,0	44,5	54,5	5	1	01070 10 1	0,360	6	1	OG302 43 0
50 / 50	99,0	49,5	49,5	5	1	01070 10 1	0,360	6	1	OG302 23 0
45 / 60	104,0	44,5	59,5	5	1	01070 10 1	0,375	6	1	OG302 54 0
55 / 50	104,0	54,5	49,5	5	1	01070 10 1	0,375	6	1	OG302 64 0
30 / 80	109,0	29,5	79,5	5	1	01070 10 1	0,390	6	1	OG302 37 0
40 / 70	109,0	39,5	69,5	5	1	01070 10 1	0,390	6	1	OG302 35 0
50 / 60	109,0	49,5	59,5	5	1	01070 10 1	0,390	6	1	OG302 36 0
60 / 50	109,0	59,5	49,5	5	1	01070 10 1	0,390	6	1	OG302 89 0
55 / 60	114,0	54,5	59,5	5	1	01070 10 1	0,400	6	1	OG302 71 0
55 / 65	119,0	54,5	64,5	5	1	01070 10 1	0,420	6	1	OG302 72 0
60 / 60	119,0	59,5	59,5	5	1	01070 10 1	0,420	6	1	OG302 40 0
65 / 55	119,0	64,5	54,5	5	1	01070 10 1	0,420	6	1	OG302 86 0

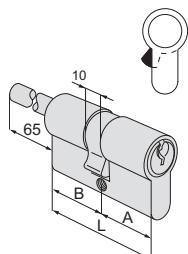

- Double cylinder with adjustable thumb turn shaft
- To be combined with inside rose item 1.06458.20
- ON REQUEST:
Knobs series 06353, 06355, 06356, 06357

30 / 30	59,0	29,5	29,5	5	1	01070 10 1	0,260	6	1	OG307 07 0
35 / 30	64,0	34,5	29,5	5	1	01070 10 1	0,270	6	1	OG307 81 0
40 / 30	69,0	39,5	29,5	5	1	01070 10 1	0,272	6	1	OG307 12 0
45 / 30	74,0	44,5	29,5	5	1	01070 10 1	0,287	6	1	OG307 91 0
50 / 30	79,0	49,5	29,5	5	1	01070 10 1	0,300	6	1	OG307 90 0
60 / 30	89,0	59,5	29,5	5	1	01070 10 1	0,320	6	1	OG307 87 0
70 / 30	99,0	69,5	29,5	5	1	01070 10 1	0,340	6	1	OG307 88 0

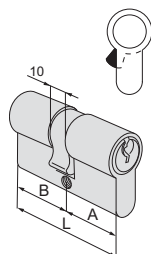

- Nickel-plated single cylinder with special cam 90° for series 46305 locks
- 3 keys
- Fixing screws

30 / 30	59,0	29,5	29,5	5	1	01070 10 1	0,216	12	1	OG303 07 0 12
---------	------	------	------	---	---	------------	-------	----	---	---------------

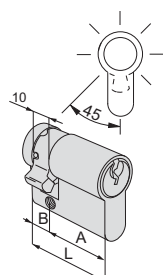

- Nickel-plated single cylinder with special cam 90° for series 46305 locks
- 3 keys
- Fixing screws

30 / 10	39,5	29,5	10,0	5			0,155	12	1	OG305 02 0 12
---------	------	------	------	---	--	--	-------	----	---	---------------



Technical features:

- Casing, keys and main elements made from brass
- Emergency key for hotel function
- Keyed Alike or master key system (to be defined) (see the On Request optional section)
- cylinder body numbering as standard

Supplied as standard:

- 3 customer type keys
- Fixing screw
- Inside thumb turn

Finishes:

- STANDARD: painted polished brass (fin. 66)
- ON REQUEST: Nickel-plated sanded brass (fin. 12)

Standards:

- Compliant with standard EN 1303: 2015
 - Key Related Security: class 4
 - Attack Resistance: class 0
 - Durability: class 6

EN 1303:15	KEY RELATED SECURITY	1	2	3	4	5	6
	ATTACK RESISTANCE	0	A	B	C	D	
	DURABILITY	1	2	3	4	5	6

C2000

Type	Description	Comm. dim.	Key item	Kg	Pieces	ITEM			
						Type	Dim.	Hand	Fin.

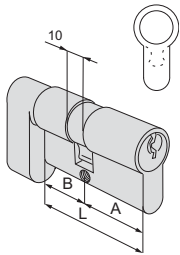

- Double cylinder with installed thumb turn
- Industrial packaging

30 / 30	59,0 29,5 29,5 5	1 01070 10 1	0,237	6	1	OG308	07	0	66
30 / 35	64,0 29,5 34,5 5	1 01070 10 1	0,237	6	1	OG308	26	0	66
35 / 30	64,0 34,5 29,5 5	1 01070 10 1	0,237	6	1	OG308	81	0	66
33 / 33	65,0 32,5 32,5 5	1 01070 10 1	0,237	6	1	OG308	10	0	66
35 / 35	69,0 34,5 34,5 5	1 01070 10 1	0,237	6	1	OG308	13	0	66
40 / 30	69,0 39,5 29,5 5	1 01070 10 1	0,237	6	1	OG308	12	0	66
30 / 45	74,0 29,5 44,5 5	1 01070 10 1	0,237	6	1	OG308	27	0	66
45 / 30	74,0 44,5 29,5 5	1 01070 10 1	0,237	6	1	OG308	91	0	66
30 / 50	79,0 29,5 49,5 5	1 01070 10 1	0,237	6	1	OG308	17	0	66
35 / 45	79,0 34,5 44,5 5	1 01070 10 1	0,237	6	1	OG308	19	0	66
45 / 35	79,0 44,5 34,5 5	1 01070 10 1	0,237	6	1	OG308	85	0	66
40 / 45	84,0 39,5 44,5 5	1 01070 10 1	0,237	6	1	OG308	30	0	66
35 / 50	84,0 34,5 49,5 5	1 01070 10 1	0,237	6	1	OG308	31	0	66
43 / 43	85,0 42,5 42,5 5	1 01070 10 1	0,237	6	1	OG308	46	0	66
30 / 60	69,0 29,5 59,5 5	1 01070 10 1	0,237	6	1	OG308	20	0	66
40 / 50	89,0 39,5 49,5 5	1 01070 10 1	0,237	6	1	OG308	21	0	66
45 / 45	89,0 44,5 44,5 5	1 01070 10 1	0,237	6	1	OG308	29	0	66
55 / 35	89,0 54,5 34,5 5	1 01070 10 1	0,237	6	1	OG308	97	0	66
35 / 60	94,0 34,5 59,5 5	1 01070 10 1	0,237	6	1	OG308	38	0	66
60 / 35	94,0 59,5 34,5 5	1 01070 10 1	0,237	6	1	OG308	A1	0	66
45 / 55	99,0 44,5 54,5 5	1 01070 10 1	0,237	6	1	OG308	43	0	66
55 / 45	99,0 54,8 44,5 5	1 01070 10 1	0,237	6	1	OG308	99	0	66
60 / 45	104,0 59,5 44,5 5	1 01070 10 1	0,237	6	1	OG308	A6	0	66
30 / 80	109,0 29,5 79,5 5	1 01070 10 1	0,237	6	1	OG308	37	0	66
60 / 50	109,0 59,5 49,5 5	1 01070 10 1	0,237	6	1	OG308	89	0	66
55 / 65	119,0 44,5 64,5 5	1 01070 10 1	0,237	6	1	OG308	72	0	66
65 / 55	119,0 64,5 54,5 5	1 01070 10 1	0,237	6	1	OG308	86	0	66

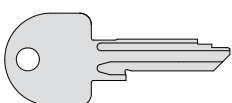

- MK-EME Key

0,014 1 1 01310 25 1 00 00 MK



Technical features:

- brass body
- brass plugs
- self-lubricating sintered steel projecting DIN cam

Finishes:

- STANDARD:
sanded brass (fin. 00)
- ON REQUEST:
nickel-plated brass (fin. 12)

C2000

Type	Description	Comm. dim.	Key item	Kg	Pieces	ITEM			
						Type	Dim.	Hand	Fin.

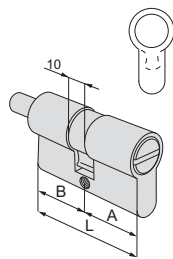

- Double cylinder for bathroom doors with thumb turn shaft
- No keys
- ON REQUEST:
Knobs series 06353, 06355, 06356, 06357

27 / 27	53,0 26,5 26,5	0,180	6	1	0G325 05 0
27 / 33	59,0 26,5 32,5	0,200	6	1	0G325 C8 0
30 / 30	59,0 29,5 29,5	0,200	6	1	0G325 07 0
33 / 33	65,0 32,5 32,5	0,220	6	1	0G325 10 0
35 / 35	69,0 34,5 34,5	0,240	6	1	0G325 13 0
40 / 30	69,0 39,5 29,5	0,240	6	1	0G325 12 0

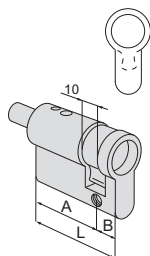

- Single cylinder with thumb turn shaft
- ON REQUEST:
Knobs series 06353, 06355, 06356, 06357

30 / 10	39,5 23,5 10,0	0,138	6	1	0G359 02 0
33 / 10	42,5 32,5 10,0	0,151	6	1	0G359 09 0
35 / 10	44,5 34,5 10,0	0,130	6	1	0G359 07 0
37 / 10	46,5 36,5 10,0	0,138	6	1	0G359 10 0
40 / 10	49,5 39,5 10,0	0,151	6	1	0G359 03 0
43 / 10	52,5 42,5 10,0	0,130	6	1	0G359 11 0



Technical features:

- brass body
- brass plugs
- pins:
 - in hardened steel
- drivers:
 - in brass, mushroom-type anti-picking and cylindrical
- phosphor bronze springs
- KEY
 - nickel-plated brass
 - long key for protective roses compatibility
- Numerical coding on the head.

Supplied as standard:

- 3 keys
- Fixing screw

Finishes:

- STANDARD:
 - sanded brass (fin. 00)
- ON REQUEST:
 - nickel-plated brass (fin. 12)
 - polished brass (fin. 66)

C2000

Type	Description	For locks series	L	Pins	Key item	Unit weight 	Pieces 	ITEM					
								Type	Dim. Hand	Fin.	Pers. Spec.		
	• Rim cylinder	1A610	5	1	01070 10 1	0,182	6	1	0G500	00	0		
	• Round cylinder	1A611	105,0	5	1	01070 10 1	0,193	6	1	0G200	05	0	
			55,0	5	1	01070 10 1	0,168	6	1	0G200	55	0	
			65,0	5	1	01070 10 1	0,165	6	1	0G200	65	0	
			75,0	5	1	01070 10 1	0,174	6	1	0G200	75	0	
			85,0	5	1	01070 10 1	0,185	6	1	0G200	85	0	
	• Cylinder set	1A630, 11611, 50111, 50131	5	1	01070 10 1	0,250	6	1	0G115	00	0		
	• Cylinder set, with round external cylinder	1A631, 1A721, 1A731	55,0	5	1	01070 10 1	0,255	6	1	0G150	00	0	
	• Cylinder set	50120, 50125, 50160, 50170, 50210, 50220	5	1	01070 10 1	0,250	6	1	02102	00	0		
		11630	5	1	01070 10 1	0,255	6	1	02104	00	0		
		11670	5	1	01070 10 1	0,262	6	1	02146	00	0		

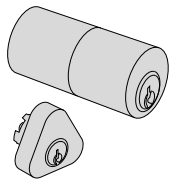
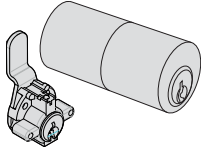
Type	Description	For locks series	Key item		Unit weight	Pieces	ITEM							
			L	Pins			kg	Box	Type	Dim.	Hand	Fin.	Pers.	Spec.
	<ul style="list-style-type: none"> • Cylinder set, with round external cylinder 	50121, 50126, 50141, 50161, 50171, 50211, 50221, 50420, 50430, 50471, 50521, 50561, 50571	55,0	5	1 01070 10 1	0,256	6	1	02106	00	0			
		11631, 11731, 11931	55,0	5	1 01070 10 1	0,256	6	1	02110	00	0			
		11823	70,0	5	1 01070 10 1	0,252	6	1	02142	00	0			
		11671, 11761, 11771	55,0	5	1 01070 10 1	0,267	6	1	02145	00	0			
	<ul style="list-style-type: none"> • Cylinder set, with round external cylinder 	11721, 11921	50,0	5	1 01310 00 1	0,269	12	1	02139	00	0			



Technical features:

- brass body
- brass plug
- pins in hardened steel
- drivers in brass, cylindrical and mushroom-like for an antipicking function
- phosphor bronze springs
- KEY: nickel-plated brass

Supplied as standard:

- 3 keys
- Fixing screws
- Fixing plates

Finishes:

- STANDARD: satin brass (fin. 00)
- ON REQUEST: nickel-plated brass (fin. 12) polished brass (fin. 66)

Type	Description	For locks series	L	Pins	Key item	Unit weight 	Pieces 	ITEM				
								Type	Dim.	Hand	Spec.	
	• Rim cylinder	13010	6	1	101210 00 2	0,238	6	1	02520	00	0	
	• Rim cylinder	11610, 50110, 50130, 50180, 54570	5	1	101310 00 1	0,180	6	1	02550	25	0	
	• Cylinder for roll-up shutter locks • Finish: polished brass only (fin. 66)	41410, 41420, 41421	10,0	3	1 01320 00 2	0,089	6	1	02544	10	0	
		41010, 41110, 41111	14,0	3	1 01310 00 2	0,104	6	1	02544	14	0	
		41210, 41220, 41221, 41230, 41231, 41310, 41311, 41320	15,0	4	1 01310 00 2	0,120	6	1	02544	15	0	
	• Cylinder for gate locks • Finish: polished brass only (fin. 66)	42010, 42020, 42030, 42110, 42120, 42210, 42310, 42410, 42420, 42510	4	1	1 01330 00 1	0,180	6	1	02156	00	0	



Technical features:

- brass body
- brass plugs
- pins in hardened steel
- drivers in brass, cylindrical and mushroom-like for an antipicking function
- phosphor bronze springs
- KEY: nickel-plated brass

Supplied as standard:

- 2 or 3 keys
- Fixing screws
- Fixing plates

Finishes:

- Various finishes according to the cylinder type

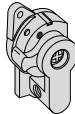
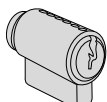
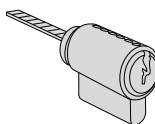
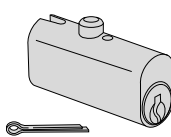
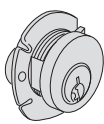
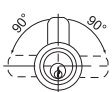
Type	Description	Door thickness Pins	Key item	Kg Unit weight	Pcs Pieces	ITEM			
						Type	Dim.	Hand	Fin. Pers. Spec.
	<ul style="list-style-type: none"> • Cross-key cylinder complete with 19 mm adaptor • For locks series 16000, 46000 • Short key version 	6	1 00210 00 0	0,119	12	1	02400	10	0
	<ul style="list-style-type: none"> • Cross-key cylinder complete with 19 mm adaptor • For locks series 16000, 46000 • Long key version 	6	1 00211 00 0	0,132	12	1	02400	11	0
	<ul style="list-style-type: none"> • Cylinder for outside operation devices item 1.07077.28.0 • Sanded brass 	5	1 01310 00 1	0,120	6	1	02649	10	0
	<ul style="list-style-type: none"> • Cylinder for outside operation devices item 1.07078.29.0 • Sanded brass 	5	1 01310 00 1	0,118	6	1	02649	11	0
	<ul style="list-style-type: none"> • 2 keys • polished brass <p>TO BE DISCONTINUED</p>	4	1 01420 00 1	0,110	6	1	72010	00	0
 	<ul style="list-style-type: none"> • 2 keys • Belt sanded brass • Key removed in vertical position • Cam item 06411 or 06412, to be ordered separately 	11	3 1 01420 00 1	0,078	12	1	72210	16	0
		15	4 1 01420 00 1	0,087	12	1	72210	20	0
		20	4 1 01420 00 1	0,097	12	1	72210	25	0
		25	4 1 01420 00 1	0,108	12	1	72210	30	0

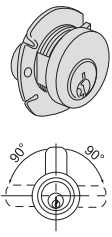
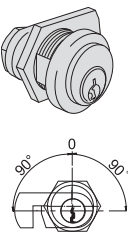
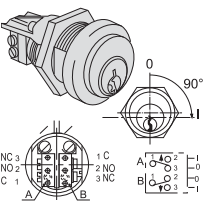
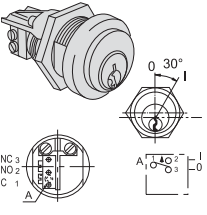
Type	Description	Door thickness Pins	Key item	Unit weight Kg	Pieces	ITEM				
						Type	Dim.	Hand	Fin.	Pers.
 <ul style="list-style-type: none"> • MARINE TYPE • 2 keys • Chrome -plated brass • Key removed in vertical position • Cam item 1.06412.51.0, specify with order 		11	3	1 01420 00 1	0,077	12	1	72215	16	0
		15	4	1 01420 00 1	0,085	12	1	72215	20	0
		20	4	1 01420 00 1	0,094	12	1	72215	25	0
		25	4	1 01420 00 1	0,105	12	1	72215	30	0
 <ul style="list-style-type: none"> • 3 keys • Nickel-plated brass • Vertical key extraction • Deadbolt to choose from items 1.06414.20.0 and 1.06414.30.0 (specify in order) 		17	5	1 01310 00 1	0,135	6	1	72250	26	0
 <ul style="list-style-type: none"> • 3 keys • Nickel-plated brass • Microswitch (7 A, 250 V) with terminals to be welded • Automatic return to key extraction position (0) 		17	5	1 01310 00 1	0,145	6	1	72251	01	0
 <ul style="list-style-type: none"> • 3 keys • Nickel-plated brass • Microswitch (7 A, 250 V) with terminals to be welded • Automatic return to key extraction position (0) 		17	5	1 01310 00 1	0,144	6	1	72251	03	0



- Technical features:**
- brass body
 - brass plugs
 - pins in hardened steel
 - drivers in brass, cylindrical and mushroom-like for an antipicking function
 - phosphor bronze springs
 - self-lubricating sintered steel cam
 - KEY: nickel-plated brass

- Supplied as standard:**
- 3 keys
 - Fixing screw
- Finishes:**
- STANDARD: sanded brass (fin. 00)
 - ON REQUEST: nickel-plated brass (fin. 12)

Type	Description	Comm. dim.	Key item				Kg	Pieces	ITEM			
			L	A	B	Pins			Type	Dim.	Hand	Fin.

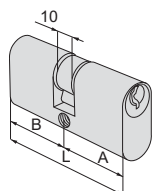

• Double cylinder

20 / 20	41,4	20,7	20,7	3	1	01425 00 1	0,120	12	1	08210 01 0			
28 / 28	55,4	27,7	27,7	5	1	01410 00 1	0,168	12	1	08210 02 0			
30 / 30	60,0	30,0	30,0	5	1	01410 00 1	0,180	12	1	08210 05 0			
28 / 35	62,7	27,7	35,0	5	1	01410 00 1	0,187	12	1	08210 06 0			
30 / 40	70,0	30,0	40,0	5	1	01410 00 1	0,204	12	1	08210 12 0			
35 / 35	70,0	35,0	35,0	5	1	01410 00 1	0,205	12	1	08210 13 0			
28 / 45	72,7	27,7	45,0	5	1	01410 00 1	0,210	6	1	08210 14 0			
28 / 53	80,7	27,7	53,0	5	1	01410 00 1	0,233	6	1	08210 16 0			
40 / 40	80,0	40,0	40,0	5	1	01410 00 1	0,231	6	1	08210 18 0			

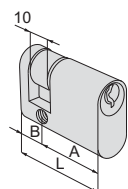

• Single cylinder

28 / 10	38,0	27,7	10,3	5	1	01410 00 1	0,124	12	1	08220 02 0			
----------------	------	------	------	---	---	------------	-------	----	---	-------------------	--	--	--

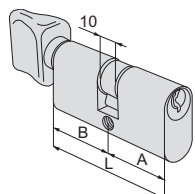

• Thumb turn double cylinder
• Black nylon knob

28 / 28	55,4	27,7	27,7	5	1	01410 00 1	0,183	6	1	08230 02 0			
35 / 28	62,7	35,0	27,7	5	1	01410 00 1	0,190	6	1	08230 06 0			

Type	Description	For series/item	Unit weight Kg	Pieces	ITEM					
					Type	Dim.	Hand	Fin.	Pers.	Spec.
	<ul style="list-style-type: none"> Belt sanded brass rose to be used with European profile cylinders 		0,009	100	1	06010	00	0		
	<ul style="list-style-type: none"> Belt sanded brass rose to be used with European profile cylinders 		0,008	100	1	06011	00	0		
	<ul style="list-style-type: none"> Belt sanded brass rose to be used with European profile cylinders 		0,009	100	1	06012	00	0		
	<ul style="list-style-type: none"> Belt sanded brass rose to be used with rim cylinders (diameter 25 mm.) 		0,010	100	1	06018	25	0		
	<ul style="list-style-type: none"> Belt sanded brass rose to be used with oval cylinders 	82000	0,007	100	1	06027	00	0		

Type	Description	For series/item	Unit weight Pieces	ITEM			
				Type	Dim.	Hand	Fin.
	<ul style="list-style-type: none"> Polished brass rose to be used with European profile cylinders 		0,024 100	1	06043	00	0
	<ul style="list-style-type: none"> Aluminium knob, black lacquered 		0,038 6	1	06353	00	0 44
	<ul style="list-style-type: none"> Aluminium knob, gold bronze anodised 		0,040 6	1	06353	00	0 60
	<ul style="list-style-type: none"> Aluminium knob, aluminium anodised 		0,037 6	1	06353	00	0 62
	<ul style="list-style-type: none"> Aluminium knob, dark brown bronze anodised 		0,040 6	1	06353	00	0 64
	<ul style="list-style-type: none"> Chrome-plated sanded brass knob for pre-set cylinders 		0,060 6	1	06354	00	0 23
	<ul style="list-style-type: none"> Chrome-plated painted brass knob for pre-set cylinders 		0,060 6	1	06354	00	0 68
	<ul style="list-style-type: none"> Nickel-plated brass knob 		0,051 6	1	06355	00	0 12
	<ul style="list-style-type: none"> Laquered polished brass knob 		0,060 6	1	06355	00	0 66
	<ul style="list-style-type: none"> Nickel-plated brass knobs 		0,180 6	1	06356	00	0 12
	<ul style="list-style-type: none"> Laquered polished brass knob 		0,183 6	1	06356	00	0 66
	<ul style="list-style-type: none"> Nickel-plated brass knobs 		0,062 6	1	06357	00	0 12
	<ul style="list-style-type: none"> Laquered polished brass knob 		0,165 6	1	06357	00	0 66

Type	Description	For series/item	Unit weight Pieces	ITEM				
				Type	Dim.	Hand	Fin.	Pers. Spec.
	• Zinc-plated steel cam	72210	0,012 12	1	06411	01	0	
				1	06411	02	0	
				1	06411	03	0	
				1	06411	04	0	
	• Zinc-plated steel cam	72210	0,014 12	1	06412	01	0	
				1	06412	02	0	
				1	06412	03	0	
				1	06412	04	0	
	• Zinc-plated steel cam	72215	0,013 12	1	06412	51	0	
	• Zinc-plated steel cam	72350	0,007 12	1	06413	01	0	
				1	06413	02	0	
				1	06413	03	0	
				1	06413	04	0	
	• Zinc-plated steel cam	72350	0,008 12	1	06414	01	0	
				1	06414	02	0	
				1	06414	03	0	
				1	06414	04	0	
	• Zinc plated steel cam	0A410, 0M410, 0N410, 0P410, 0Q410, 72250	0,019 12	1	06414	20	0	
	• Zinc plated steel cam	0R410, 0X410	0,018 12	1	06414	25	0	
	• Zinc plated steel cam	0A410, 0M410, 0N410, 0P410, 0Q410, 72250	0,010 12	1	06414	30	0	

Type	Description	For series/item	Unit weight Pieces	ITEM				
				Type	Dim.	Hand	Fin.	Pers. Spec.
	<ul style="list-style-type: none"> • Cylinder spacer kit • L = 36 mm. • Total cylinder length 60 mm 	0G200, 0A210, 0L210, 0N210, 0M210, 0P210, 0Q410	0,030	12	1	07165	00	0
	<ul style="list-style-type: none"> • Cylinder spacer kit • L = 46 mm. • Total cylinder length 70 mm 	0G200, 0A210, 0L210, 0N210, 0M210, 0P210, 0Q410	0,038	12	1	07165	01	0
	<ul style="list-style-type: none"> • Cylinder spacer kit • L = 56 mm. • Total cylinder length 80 mm 	0G200, 0A210, 0L210, 0N210, 0M210, 0P210, 0Q410	0,045	12	1	07165	02	0
	<ul style="list-style-type: none"> • Cylinder spacer kit • L = 66 mm. • Total cylinder length 90 mm 	0G200, 0A210, 0L210, 0N210, 0M210, 0P210, 0Q410	0,050	12	1	07165	03	0
	<ul style="list-style-type: none"> • Cylinder spacer kit • L = 76 mm. • Total cylinder length 100 mm 	0G200, 0A210, 0L210, 0N210, 0M210, 0P210, 0Q410	0,052	12	1	07165	04	0

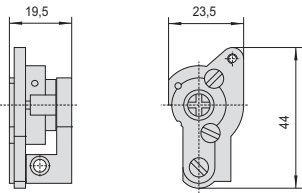

02400

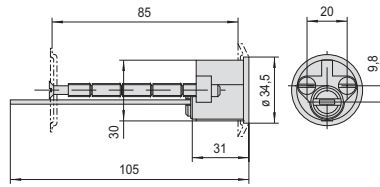

1.02520.00

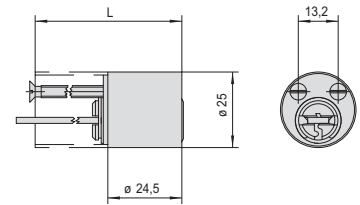

0A210, 0E200, 0G200, 0M210, 0N210
0P210, 0Q210, 0R210, 0X210

1

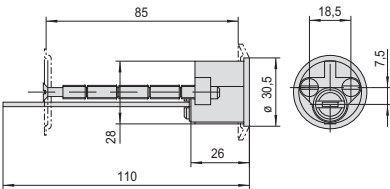

0A510, 0E500, 0G500, 0M510, 0N510
0P510, 0Q510, 0R510, 0X510

4

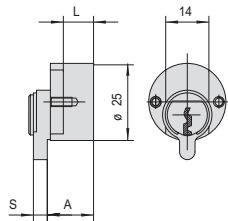

	S	A	L
1.02544.10	5,5	13	10
1.02544.14	6,5	16	14
1.02544.15	5,5	18	15

7

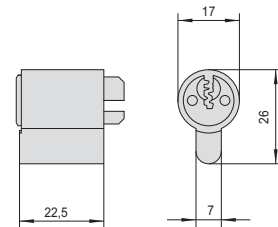

1.02649.01, 1.02650.01, 1.0A610.00, 1.0E600.00
1.0M610.00, 1.0N610.00, 1.0P610.00
1.0Q610.00, 1.0R610.00, 1.0X610.00

2

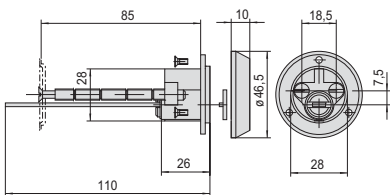

1.0A510.11, 1.0L510.10,
1.0M510.10, 1.0P510.10

5

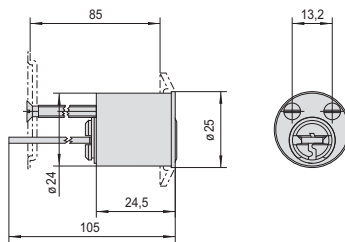

1.02550.25

8

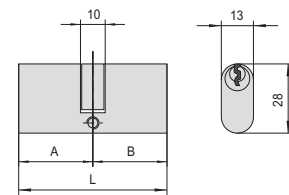

08210

3

6

9

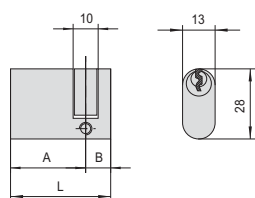

1.08220.02

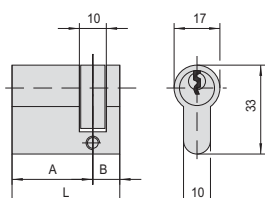

0A314, 0E304, 0G304
0E305, 0G305, 0M324
0N314, 0N324, 0P314
0Q314, 0R3M4, 0X3M4

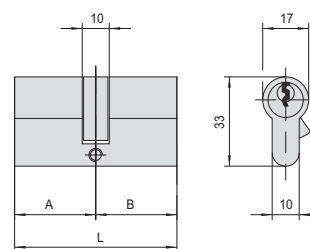

0A3S1, 0G300, 0G301, 0G303
0E300, 0E301, 0M3T1, 0N310
0N3S1, 0P3S1, 0Q310, 0Q311
0R3M1, 0X3M1

10

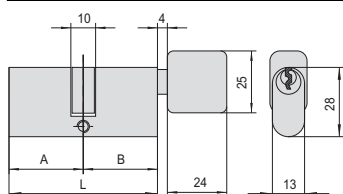

08230

13

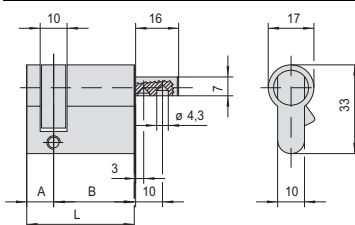

0G359

16

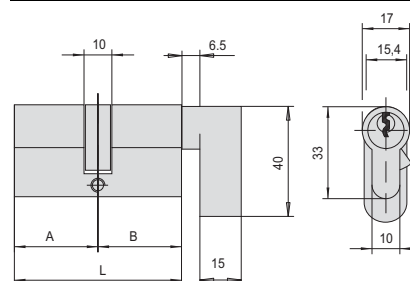

0G308

11

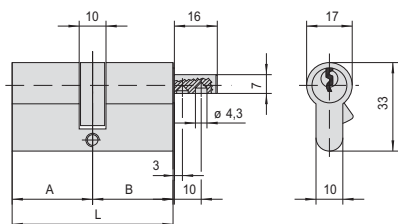

0A3S2, 0A312, 0E302, 0G302, 0G325, 0M3T2,
0N312, 0N3S2, 0Q312, 0R3M2, 0X3M2

14

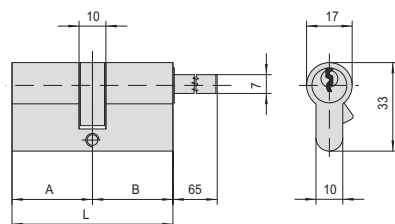

0A3S7, 0A317, 0G307, 0M3T7, 0N317
0N3S7, 0P3S7, 0Q317, 0R3M7, 0X3M7

17

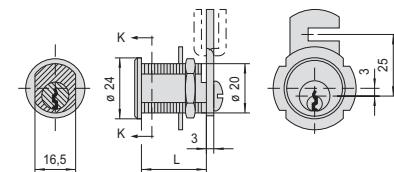

1.72210.16 - 1.72215.16
1.72210.20 - 1.72215.20
1.72210.25 - 1.72215.25
1.72210.30 - 1.72215.30

L
16,5
20
25
30

12

15

18

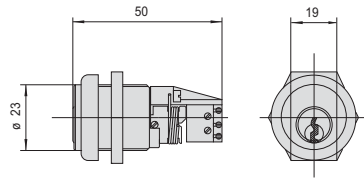
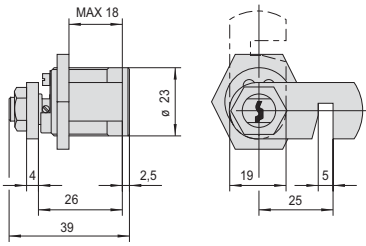

72251, 0A415, 0M415, 0P415
0Q415, 0R415, 0X415

1.72250.26, 1.0A410.00, 1.0M410.00,
1.0N410.00, 1.0P410.00, 1.0Q410.00
1.0R410.00, 1.0X410.00

19

20



AP4 steel padlocks	131
Astral Tekno steel padlocks	132
C3000 steel padlocks.....	133
Astral steel padlocks	134
LIM steel padlocks.....	135
Padlocks for european profile cylinder.....	136
Marine Type padlocks.....	137
Brass padlocks	138

CISA Locking Line padlocks with steel sleeve.....	139
Rectangular brass padlocks CISA Locking Line.....	140
Marine Type padlocks CISA Locking Line.....	141
CISA Locking Line brass padlocks	142
CISA Locking Line padlocks with combination lock .	144
Spare parts for padlocks.....	145
Accessories for padlocks	146
Spare parts for padlocks.....	147

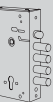



Steel padlocks

WITH AP4, ASTRAL TEKNO,
AND C3000 CYLINDERS.



Attack and weather resistant



Protected key duplication





Technical features:

- Security Card: protected duplication
- Solid body in carbonitrided steel with corrosion resistant chemical nickel plating
- Hardened steel shackle with chemical nickel plating
- Cylinder protection plate in carbonitrided steel with chemical nickel plating
- Replaceable cylinder
- Keys:
 - flat reversible
 - in nickel silver alloy, with mobile element
 - numerical code on key bow

Supplied as standard:

- Code Card
- 2 keys

Standards:

- Product compliant with the european standard EN 12320:12

AP4

Type	Description	Key item						Unit weight	Pieces	ITEM			
		A	C	D	L	S	Pins			Type	Dim.	Hand	Fin.

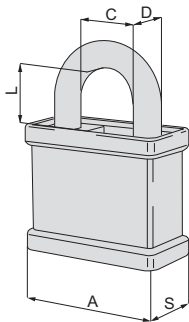

• Key removable in locked position only

55	25,0	11,0	25,0	25,0	11	1 00810 00 0	0,565	6	1	2805P	55	0		
55	25,0	11,0	45,0	25,0	11	1 00810 00 0	0,601	6	1	2805P	56	0		
55	26,0	11,0	65,0	25,0	11	1 00810 00 0	0,610	6	1	2805P	57	0		
70	31,0	14,0	25,0	26,0	11	1 00810 00 0	0,880	6	1	2805P	70	0		
70	31,0	14,0	45,0	26,0	11	1 00810 00 0	0,927	6	1	2805P	71	0		
70	31,0	14,0	65,0	26,0	11	1 00810 00 0	0,954	6	1	2805P	72	0		

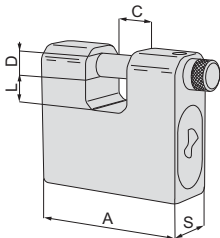

66	20,0	10,0	11,0	25,0	11	1 00810 00 0	0,685	6	1	2855P	66	0		
66	18,0	14,0	17,5	28,0	11	1 00810 00 0	0,837	6	1	2855P	67	0		
75	27,0	12,0	13,5	28,0	11	1 00810 00 0	0,852	6	1	2855P	75	0		
84	36,0	12,0	17,5	28,0	11	1 00810 00 0	0,970	6	1	2855P	84	0		
84	36,0	14,0	17,5	28,0	11	1 00810 00 0	0,983	6	1	2855P	85	0		



Technical features:

- Security Card: protected duplication
- Solid body in carbonitrided steel with corrosion resistant chemical nickel plating
- Hardened steel shackle with chemical nickel plating
- Cylinder protection plate in carbonitrided steel with chemical nickel plating
- Replaceable cylinder

Keys:

- flat reversible
- numerical code on key bow

Supplied as standard:

- Security Card
- 2 keys

Standards:

- Product compliant with the european standard EN 12320:12

Astral Tekno

Type	Description	Key item						Kg	Box	ITEM	
		A	C	D	L	S	Pins				Type

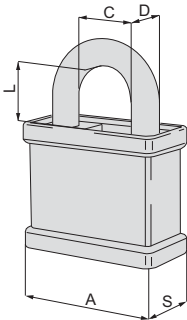

• Key removable in locked position only

55	25,0	11,0	25,0	25,0	10	1	00690 00 0 00	0,565	6	1	2805M	55	0
55	25,0	11,0	45,0	25,0	10	1	00690 00 0 00	0,601	6	1	2805M	56	0
55	26,0	11,0	65,0	25,0	10	1	00690 00 0 00	0,610	6	1	2805M	57	0
70	31,0	14,0	25,0	26,0	10	1	00690 00 0 00	0,880	6	1	2805M	70	0
70	31,0	14,0	45,0	26,0	10	1	00690 00 0 00	0,927	6	1	2805M	71	0
70	31,0	14,0	65,0	26,0	10	1	00690 00 0 00	0,954	6	1	2805M	72	0

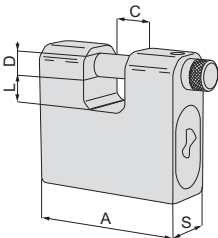

66	20,0	10,0	11,0	25,0	10	1	00690 00 0 00	0,685	6	1	2855M	66	0
66	18,0	14,0	17,5	28,0	10	1	00690 00 0 00	0,852	6	1	2855M	67	0
75	27,0	12,0	13,5	28,0	10	1	00690 00 0 00	0,852	6	1	2855M	75	0
84	36,0	12,0	17,5	28,0	10	1	00690 00 0 00	0,970	6	1	2855M	84	0
84	36,0	14,0	17,5	28,0	10	1	00690 00 0 00	0,983	6	1	2855M	85	0



Technical features:

- Security Card: protected duplication
- Solid body in carbonitrided steel with corrosion resistant chemical nickel plating
- Hardened steel shackle with chemical nickel plating
- Cylinder protection plate in carbonitrided steel with chemical nickel plating
- Replaceable cylinder

Keys:

- numerical code on key bow

Supplied as standard:

- Security Card
- 2 keys

Standards:

- Product compliant with the european standard EN 12320:12

C3000

Type	Description	Key item						Unit weight	Pieces	ITEM			
		A	C	D	L	S	Pins			Type	Dim.	Hand	Fin.

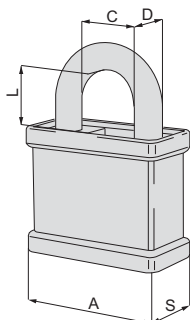

• Key removable in locked position only

55	25,0	11,0	25,0	25,0	6	1 00430 00 1	0,565	6	1	2805N	55	0
55	25,0	11,0	45,0	25,0	6	1 00430 00 1	0,601	6	1	2805N	56	0
55	26,0	11,0	65,0	25,0	6	1 00430 00 1	0,610	6	1	2805N	57	0
70	31,0	14,0	25,0	26,0	6	1 00430 00 1	0,880	6	1	2805N	70	0
70	31,0	14,0	45,0	26,0	6	1 00430 00 1	0,927	6	1	2805N	71	0
70	31,0	14,0	65,0	26,0	6	1 00430 00 1	0,954	6	1	2805N	72	0

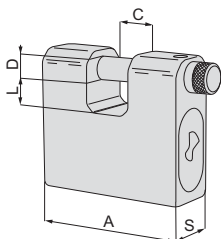

66	20,0	10,0	11,0	25,0	6	1 00430 00 1	0,685	6	1	2855N	66	0
66	18,0	14,0	17,5	28,0	6	1 00430 00 1	0,837	6	1	2855N	67	0
75	27,0	12,0	13,5	28,0	6	1 00430 00 1	0,852	6	1	2855N	75	0
84	36,0	12,0	17,5	28,0	6	1 00430 00 1	0,970	6	1	2855N	84	0
84	36,0	14,0	17,5	28,0	6	1 00430 00 1	0,983	6	1	2855N	85	0



Technical features:

- Carbonitrided solid steel body, with chemical anti-corrosion nickel-plating treatment
- Hardened steel shackle, with chemical nickel-plating treatment
- Carbonitrided steel cylinder protection plate, with chemical nickel-plating treatment
- The removable cylinder can be either rekeyed or replaced
- KEY:
- flat reversible keys
- numbered on key bow

Supplied as standard:

- 2 keys
- Code Card

Standards:

- Product compliant with the european standard EN 12320:12

Astral

Type	Description	Key item						Unit weight	Pieces	ITEM				
		A	C	D	L	S	Pins			Type	Dim.	Hand	Fin.	Pers.

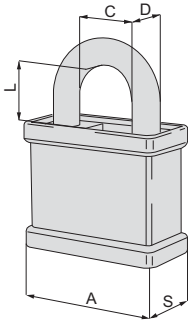

• Key removable in locked position only

55	25,0	11,0	45,0	25,0	10	1 00620 01 0	0,586	6	1	28053	56	0
70	31,0	14,0	25,0	26,0	10	1 00620 01 0	0,854	6	1	28053	70	0
70	31,0	14,0	45,0	26,0	10	1 00620 01 0	0,903	6	1	28053	71	0
70	31,0	14,0	65,0	26,0	10	1 00620 01 0	0,954	6	1	28053	72	0

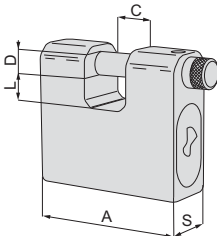

66	20,0	10,0	11,0	25,0	10	1 00620 01 0	0,677	6	1	28553	66	0
66	18,0	14,0	17,5	28,0	10	1 00620 01 0	0,837	6	1	28553	67	0
75	27,0	12,0	13,5	28,0	10	1 00620 01 0	0,843	6	1	28553	75	0
84	36,0	12,0	17,5	28,0	10	1 00620 01 0	0,955	6	1	28553	84	0
84	36,0	14,0	17,5	28,0	10	1 00620 01 0	0,983	6	1	28553	85	0



Technical features:

- Carbonitrided solid steel body, with chemical anti-corrosion nickel-plating treatment
- Hardened steel shackle, with chemical nickel-plating treatment
- **The removable cylinder can be either rekeyed or replaced**
- Carbonitrided steel plug protection plate
- Carbonitrided steel cylinder protection plate, with chemical nickel-plating treatment
- Desmopan impact resistant protection device (for the 28050 series)
- LIM patented key profile

Supplied as standard:

- 2 keys

Standards:

- Product compliant with the european standard EN 12320:12

Type	Description	Key item					Unit weight	Pieces	ITEM			
		A	C	D	L	S			Type	Dim.	Hand	Fin.

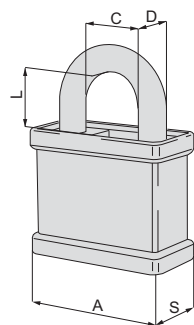

• Key removable in locked position only

55	25,0	11,0	25,0	25,0	5	1 00401 00 1	0,565	6	1	28050	55	0
55	25,0	11,0	45,0	25,0	5	1 00401 00 1	0,601	6	1	28050	56	0
55	26,0	11,0	65,0	25,0	5	1 00401 00 1	0,610	6	1	28050	57	0
70	31,0	14,0	25,0	26,0	5	1 00401 00 1	0,880	6	1	28050	70	0
70	31,0	14,0	45,0	26,0	5	1 00401 00 1	0,927	6	1	28050	71	0
70	31,0	14,0	65,0	26,0	5	1 00401 00 1	0,954	6	1	28050	72	0

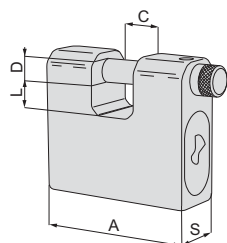

66	20,0	10,0	11,0	25,0	5	1 00401 00 1	0,685	6	1	2855L	66	0
66	18,0	14,0	17,5	28,0	5	1 00401 00 1	0,837	6	1	2855L	67	0
75	27,0	12,0	13,5	28,0	5	1 00401 00 1	0,852	6	1	2855L	75	0
84	36,0	12,0	17,5	28,0	5	1 00401 00 1	0,970	6	1	2855L	84	0
84	36,0	14,0	17,5	28,0	5	1 00401 00 1	0,983	6	1	2855L	85	0



Technical features:

- Brass monoblock body
- Special steel shackle
- Compatibility with European profile single cylinder (30/10 mm) to be purchased separately

Type	Description	Key item					Unit weight	Pieces	ITEM				
		A	C	D	L	S			Pins	Type	Dim.	Hand	Fin.

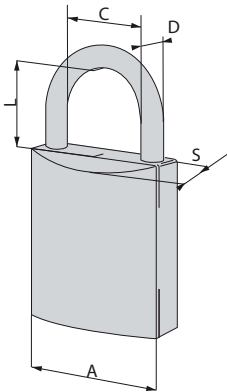

- Designed to match the following cylinders:
 - Asix item 1.0E304.02.0
 - C2000 item 1.0G304.02.0
 - Astral Tekno item 1.0M314.02.0.66CL
 - AP4S item 1.0P314.02.0.66
 - C3000 1 item 1.0N314.02.0
 - C3000S item 1.0N324.02.0.66
 - AP4S item 1.0P314.02.0.33
 - C3000 1 item 1.0N314.02.0
 - RS5 item 1.0R3M4.02.0.66
 - RX item 1.0X3M4.02.0.66

55	27,0	9,5	39,0	27,5		0,550	6	1	26810	55	0
----	------	-----	------	------	--	-------	---	---	-------	----	---



Technical features:

- Chrome-plated solid brass body
- Stainless steel shackle
- Shackle double-locking system
- CISA patented anti-tampering protection device for the bolts
- Picking resistant chrome-plated brass plate
- Item 1.26020.50/60 with LIM patented key profile

Supplied as standard:

- 2 keys

Type	Description	Key item					Unit weight	Pieces	ITEM			
		A	C	D	L	S			Type	Dim.	Hand	Fin.

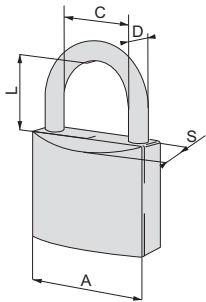

• Standard shackle

30	17,0	5,0	17,0	14,5	4	1 01430 00 1	0,098	12	1 26020 30 0
40	24,0	6,0	23,0	16,5	5	1 01410 00 1	0,175	12	1 26020 40 0
50	29,5	8,0	27,5	17,5	5	1 01310 10 1	0,295	6	1 26022 50 0
60	35,0	10,0	37,5	20,0	5	1 01310 10 1	0,462	6	1 26022 60 0

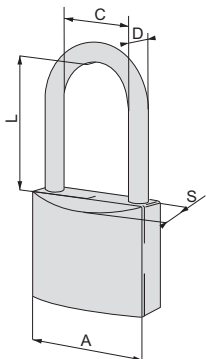

• Long shackle

40	24,0	6,0	40,0	16,5	5	1 01410 00 1	0,182	12	1 26021 40 0
----	------	-----	------	------	---	--------------	-------	----	--------------

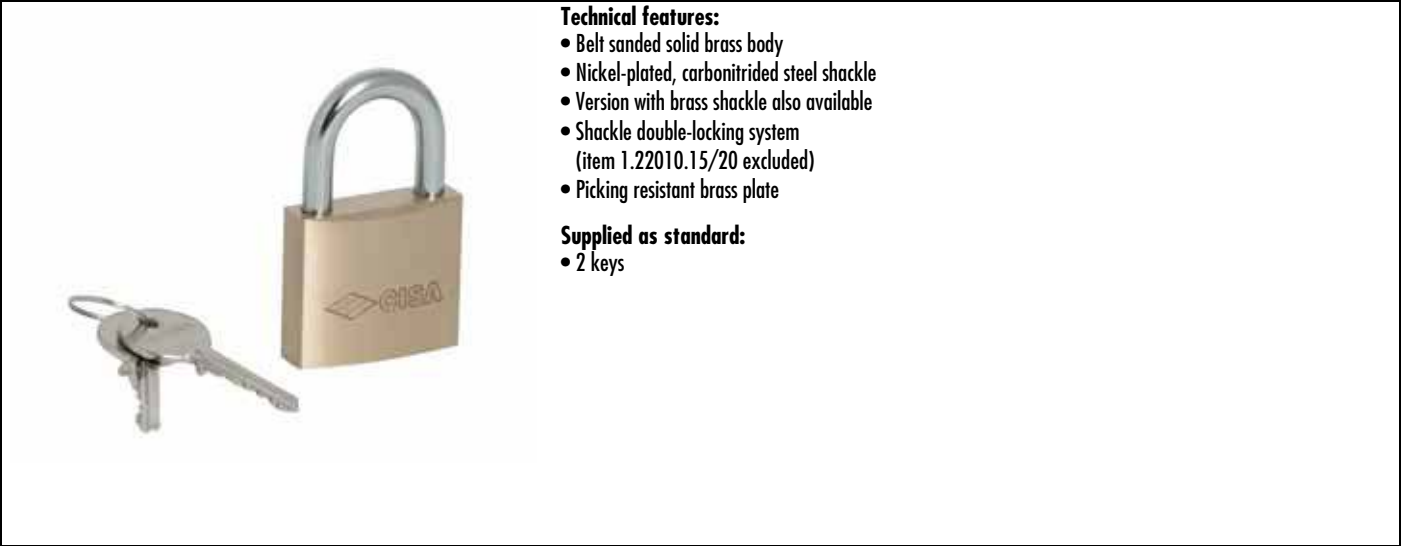

Technical features:

- Belt sanded solid brass body
- Nickel-plated, carbonitrided steel shackle
- Version with brass shackle also available
- Shackle double-locking system (item 1.22010.15/20 excluded)
- Picking resistant brass plate

Supplied as standard:

- 2 keys

Type	Description	Key item						Unit weight	Pieces	ITEM			
		A	C	D	L	S	Pins			Type	Dim.	Hand	Fin.

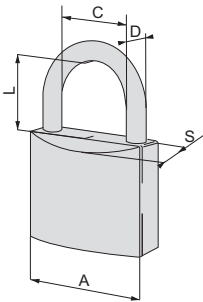

• Standard shackle

15	8,5	3,0	11,0	9,0	3	1 01510 00 1	0,022	12	1 22010 15 0
20	12,0	3,5	13,0	12,5	4	1 01440 00 1	0,038	12	1 22010 20 0
25	13,5	4,5	15,0	12,5	4	1 01440 00 1	0,065	12	1 22010 25 0
30	17,0	5,0	17,0	14,5	4	1 01430 00 1	0,095	12	1 22010 30 0
40	24,0	6,0	23,0	16,5	5	1 01410 00 1	0,172	12	1 22010 40 0
50	29,5	8,0	27,5	17,5	5	1 01310 00 1	0,292	6	1 22010 50 0
60	35,0	10,0	37,5	20,0	5	1 01310 00 1	0,435	6	1 22010 60 0

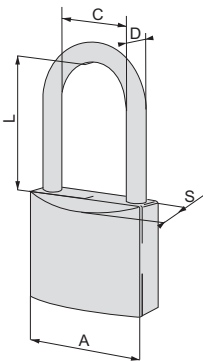

• Long shackle

20	12,0	3,5	22,0	12,5	4	1 01440 00 1	0,053	12	1 22011 20 0
30	17,0	5,0	24,0	14,5	4	1 01430 00 1	0,098	12	1 22011 30 0
30	17,0	5,0	65,0	14,5	4	1 01430 00 1	0,111	12	1 22011 31 0
40	24,0	6,0	40,0	16,5	5	1 01410 00 1	0,183	12	1 22011 40 0
40	24,0	6,0	63,5	16,5	5	1 01410 00 1	0,191	12	1 22011 41 0
50	29,5	8,0	80,0	17,5	5	1 01310 00 1	0,345	6	1 22011 50 0
50	29,5	8,0	127,0	17,5	5	1 01310 00 1	0,381	6	1 22011 52 0



Technical features:

- Brass solid body with nickel-plated hardened steel sleeve
- Nickel-plated hardened steel shackle
- Carbonitrided steel cylinder protection plate (item 1.21810.80.0)

Supplied as standard:

- 2 keys



Type	Description	Key item					Pins	Unit weight 	Pieces 	ITEM			
		A	C	D	L	S				Type	Dim.	Hand	Fin.

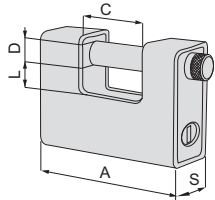

66	33,0	10,0	14,0	22,7	5	1 01040 04 1	0,598	3	1 21810 65 0
77	37,0	12,0	17,0	29,2	5	1 01040 05 1	0,843	3	1 21810 80 0



Technical features:

- Belt sanded solid brass body
- Nickel-plated hardened steel shackle with tear-resistant end

Supplied as standard:

- 2 keys



Type	Description	Key item					Unit weight	Pieces	ITEM			
		A	C	D	L	S			Type	Dim.	Hand	Fin.

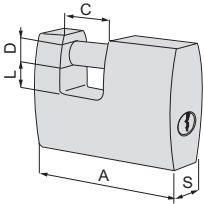

52	15,0	7,9	13,5	14,7	4	1 01040 03 1	0,197	6	1 21610 50 0
63	19,0	10,0	14,0	18,5	5	1 01040 04 1	0,330	6	1 21610 63 0
70	22,0	12,0	13,5	20,0	5	1 01040 04 1	0,439	6	1 21610 70 0
90	35,0	12,0	18,2	22,5	5	1 01040 05 1	0,728	6	1 21610 90 0



Technical features:

- Chrome-plated solid brass body
- Stainless steel shackle
- Shackle double-locking system

Supplied as standard:

- 2 keys

Type	Description	Dimensions					Key item	Unit weight 	Pieces 	ITEM			
		A	C	D	L	S				Type	Dim.	Hand	Fin.

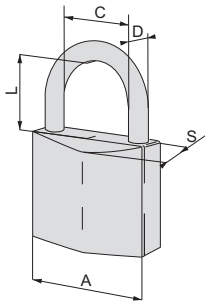

• Standard shackle

29	14,5	4,7	13,8	12,8	4	1 01040 03 1	0,085	12	1 21710 30 0				
40	19,5	6,3	22,5	13,5	4	1 01040 03 1	0,153	12	1 21710 40 0				
50	28,2	7,1	26,0	14,8	5	1 01040 04 1	0,233	6	1 21710 50 0				
60	31,3	7,9	32,2	16,1	5	1 01040 04 1	0,326	6	1 21710 60 0				

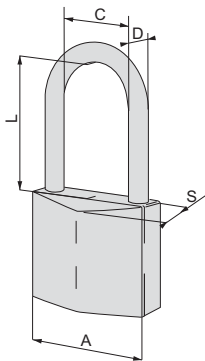

• Long shackle

40	19,5	6,3	40,0	13,5	4	1 01040 03 1	0,162	12	1 21711 40 0				
----	------	-----	------	------	---	--------------	-------	----	--------------	--	--	--	--



Technical features:

- Belt sanded solid brass body
- Nickel-plated, carbonitrided steel shackle
- Shackle double-locking system (item 1.21010.20/25.0 excluded)

Supplied as standard:

- 2 keys



Type	Description						Key item	Kg	Pieces	ITEM			
		A	C	D	L	S				Type	Dim.	Hand	Fin.

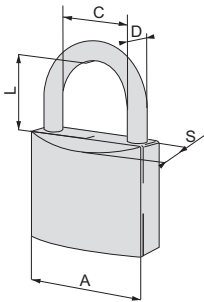

• Standard shackle

20	9,6	3,5	11,3	10,4	3	1 01040 01 1	0,039	12	1 21010 20 0			
25	13,5	3,9	13,1	12,0	4	1 01040 02 1	0,062	12	1 21010 25 0			
30	16,2	4,7	16,9	13,8	4	1 01040 03 1	0,095	12	1 21010 30 0			
40	22,1	6,3	22,4	13,8	5	1 01040 04 1	0,158	12	1 21010 40 0			
50	27,9	7,9	28,7	17,0	5	1 01040 05 1	0,272	6	1 21010 50 0			
60	33,5	9,5	34,7	17,2	5	1 01040 05 1	0,407	6	1 21010 60 0			
70	39,0	11,0	36,0	18,0	5	1 01040 05 1	0,560	6	1 21010 70 0			

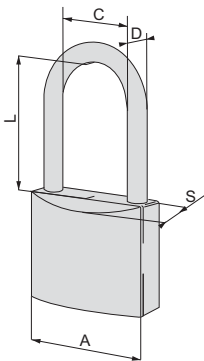

• Long shackle

30	16,2	4,7	24,0	13,8	4	1 01040 03 1	0,097	12	1 21011 30 0			
40	22,1	6,3	40,0	13,8	5	1 01040 04 1	0,165	12	1 21011 40 0			
50	27,9	7,9	80,0	17,0	5	1 01040 05 1	0,317	6	1 21011 50 0			

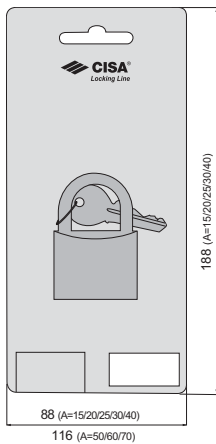

- Standard shackle
- Shrink-wrapped cardboard package

20	9,6	3,5	11,3	10,4	3	1 01040 01 1	0,039	6	1 21090 20 0			
25	13,5	3,9	13,1	12,0	4	1 01040 02 1	0,062	6	1 21090 25 0			
30	16,2	4,7	16,9	13,8	4	1 01040 02 1	0,095	6	1 21090 30 0			
40	22,1	6,3	22,4	13,8	5	1 01040 03 1	0,158	6	1 21090 40 0			
50	27,9	7,9	28,7	17,0	5	1 01040 05 1	0,272	6	1 21090 50 0			
60	33,5	9,5	34,7	17,2	5	1 01040 05 1	0,407	6	1 21090 60 0			

Type	Description	Key item					Unit weight	Pieces	ITEM			
		A	C	D	L	S			Pin	Type	Dim. Hand	Fin.

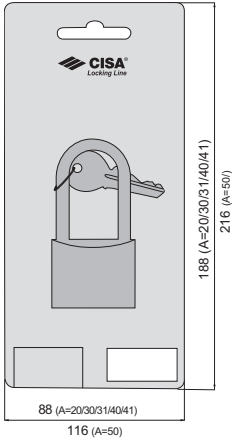

- Long shackle
- Shrink-wrapped cardboard package

30	16,2	4,7	16,9	13,8	4	1 01040 03 1	0,097	6	1 21091 30 0
40	22,1	6,3	40,0	13,8	5	1 01040 04 1	0,165	6	1 21091 40 0
50	27,9	7,9	80,0	17,0	5	1 01040 05 1	0,317	6	1 21091 50 0



Technical features:

- Brass monoblock body
- Nickel-plated carbonitrided steel shackle
- 3 disc system (1,000 combinations) for size 20/30
- 4 disc system (10,000 combinations) for size 40



Type	Description	Key item					Kg	Box	ITEM			
		A	C	D	L	S			Pins	Type	Dim.	Hand

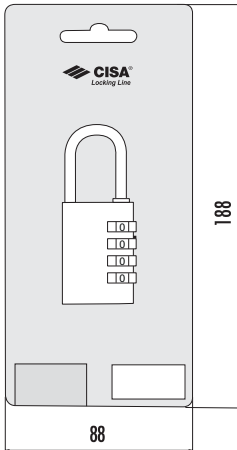

• Shrink-wrapped cardboard package







20	9,0	3,0	21,5	14,0		0,055	6	1	21190	20	0		
30	14,0	5,0	25,0	15,0		0,115	6	1	21190	30	0		
40	22,0	6,0	26,0	18,0		0,235	6	1	21190	40	0		

Type	Description	Unit weight Pieces	ITEM			
			Type	Dim.	Hand	Per. Spec.
	<ul style="list-style-type: none"> • Hardened steel cylinder protection plate • For padlocks: series 28050 dim. 55, 56, 57 280SN 	0,045 3	1	07586	04 0	
	<ul style="list-style-type: none"> • Hardened steel cylinder protection plate • For padlocks: series 28050 dim. 70, 71, 72 280SN 	0,045 3	1	07586	05 0	
	<ul style="list-style-type: none"> • Hardened steel cylinder protection plate • For padlocks: series 28052 dim. 55, 56, 57 	0,036 3	1	07586	06 1	
	<ul style="list-style-type: none"> • Hardened steel cylinder protection plate • For padlocks: series 28053 dim. 55, 56, 57 280SP, 280SM 	0,045 3	1	07586	08 0	
	<ul style="list-style-type: none"> • Hardened steel cylinder protection plate • For padlocks: series 28053 dim. 70, 71, 72 280SP, 280SM 	0,045 3	1	07586	09 0	
	<ul style="list-style-type: none"> • Hardened steel cylinder protection plate • For padlocks: series 28057 dim. 55, 56, 57 series 28353 dim. 62 	0,045 3	1	07586	10 0	
	<ul style="list-style-type: none"> • Hardened steel cylinder protection plate • For padlocks: series 2855N 	0,010 3	1	07589	02 0	
	<ul style="list-style-type: none"> • Hardened steel cylinder protection plate • For padlocks: series 28552 	0,045 3	1	07589	03 1	
	<ul style="list-style-type: none"> • Hardened steel cylinder protection plate • For padlocks: series 2855N 	0,003 3	1	07589	04 0	
	<ul style="list-style-type: none"> • Hardened steel cylinder protection plate • For padlocks: series 28559 	0,045 3	1	07589	05 0	

Type	Description	For series/item	Unit weight Pieces	ITEM			
				Type	Dim.	Hand	Fin.
	<ul style="list-style-type: none"> • Zinc plated steel padlock hasp set 		0,526 6	1	06300	14	0
	<ul style="list-style-type: none"> • Zinc plated steel padlock hasp set 		0,515 6	1	06300	18	0
	<ul style="list-style-type: none"> • Zinc plated padlock tie 	1 21610 50 0, 1 21610 63 0, 1 21810 65 0, 1 26509 70 0, 1 28550 66 0, 1 2855M 66 0, 1 2855P 66 0, 1 28553 66 0, 1 28055M 66 0, 1 288559 66 0	0,451 4	1	06301	50	0
	<ul style="list-style-type: none"> • Zinc plated padlock tie 	1 21610 50 0, 1 21610 63 0, 1 21810 65 0, 1 28550 66 0, 1 28553 66 0, 1 2855M 66 0, 1 2855N 66 0, 1 2855P 66 0, 1 28559 66 0	0,591 4	1	06301	60	0

HARDENED STEEL PADLOCKS in "UNASSEMBLED" version (suffix 91), supplied without cylinder and drill resistant plates

- Steel padlocks in "UNASSEMBLED" version (suffix 91) are supplied without cylinder and without the cylinder or padlock drill resistant plate. When ordering the padlock cylinder, you have to specify separately the relevant padlock drill resistant plate (the cylinder drill resistant plate is supplied as standard).

PADLOCK SERIES	DRILL RESISTANT PLATE	CYLINDER "LIM" CYLINDER "C3000" item 1 02650 01 0 item 1 0K610 00 0	CYLINDER "ASIX" CYLINDER "ASTRAL" item 1 0E600 00 0 item 1 0A610 00 0	CYLINDER "ASTRAL TEKNO" CYLINDER "AP4" item 1 0M610 00 0 item 1 0P610 00 0	CYLINDER "RSS" item 1 0R610 00 0
28000 (Dim. 55/56/67)	For cylinder 	Supplied as standard	Supplied as standard	Supplied as standard	Supplied as standard
	For padlock 	item 1 07586 04 0	item 1 07586 08 0	item 1 07586 08 0	item 1 07586 10 0
28000 (Dim. 70/71/72/73)	For cylinder 	Supplied as standard	Supplied as standard	Supplied as standard	Supplied as standard
	For padlock 	item 1 07586 05 0	item 1 07586 09 0	item 1 07586 09 0	item 1 07586 11 0
28500 (Dim. 66/67/75/84/85)	For cylinder 	Supplied as standard	Supplied as standard	Supplied as standard	Supplied as standard
	For padlock 	item 1 07589 02 0	item 1 07589 04 0	item 1 07589 04 0	item 1 07589 05 0



Locks for
steel doors



Cylinder electric rim locks - ElettriKa	151
Booster, Coil set Bticino, device	153
Cylinder electric rim locks	154
Cylinder rim locks for shutters	156
Cylinder mortice locks for gates.....	159
Cylinder mortice locks rolling-shutter and railings	162
Cylinder mortice locks for shutters	163
Cylinder mortice locks for railings	165

Cylinder rim locks	168
Multithrow cylinder rim locks	170
Cylinder mortice locks	171
Cylinder mortice locks, mid-rail type H=64 mm.....	172
Double-bit key mortice locks	173
Double-bit key mortice locks	175
Accessories for metal lock.....	178
Dimensional drawings	187

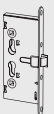
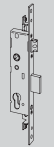



Electric locks series 11000



The renewed CISA range of electrically operated locks is the ideal solution in the residential sector for iron gates and wooden entrance doors, thanks to its easy installation and efficient solutions.

MAIN FEATURES AND BENEFITS:



**ADJUSTABLE
BACKSET**



**MADE
IN ITALY**



**HIGH
RESISTANCE
TO
CORROSION**



**CERTIFIED
PRODUCT**



cisa.com
allegion.com



ALLEGION™



Technical features:

- Painted protective steel case
- Metal striker with stainless steel swinging pin
- Rotary hook deadbolt in extruded aluminium
- 12V ac power supply
- Current absorption 3 A
- Non-handed and with a variable backset from 50 to 80 mm

Supplied as standard:

- Striker
- Instruction sheet
- Fixing screws
- 2 spacers for the striker
- 3 keys item 1.01070.10.1

On request:

- Booster device item 1.07022.00.0
- Booster plus device item 1.07022.10.0
- Coil set BTicino device item 1.07025.10.0
- Microswitch device item 1.07023.00.0
- Lighted indicator kit item 1.07126.01.0

Certification:

- ELETRIKA is certified according to the European standard prEN 14846:08:

| 3 | X | 2 | 0 | 0 | M | 6 | 0 | 2 |

- Security degree 6
(2,000 Kg lateral push resistance)

Hand:
0 = Non-handed

Elettrika



Type	Description	Cylinder	Throws	Backset	Unit weight 	Pieces 	ITEM							
							Type	Dim.	Hand	Fin.	Pers. Spec.			
<ul style="list-style-type: none"> • Back plate for lock and striker to be welded 	<p>Art. 1 0G150 00 0 Fin.12</p>	50÷80	2,750	6	1	1A721 00 0								
						• Version with BTicino coil item 1.07025.10.0	50÷80	2,710	6	1	1A721 00 0 00 PA			
						• Version with Booster item 1.07022.00.0	50÷80	2,710	6	1	1A721 00 0 00 PB			
						• Version with Booster Plus item 1.07022.10.0	50÷80	2,710	6	1	1A721 00 0 00 PC			
						• Galvanized version • Welding plate and striker spacer	50÷80	2,800	1	1	1A721 00 0 79			
<ul style="list-style-type: none"> • Back plate for lock and striker to be welded • Inner push-button • Hold open device 	<p>Art. 1 0G150 00 0 Fin.12</p>	50÷80	2,800	6	1	1A731 00 0								
						• Version with BTicino coil item 1.07025.10.0	50÷80	2,800	6	1	1A731 00 0 00 PA			
						• Version with Booster item 1.07022.00.0	50÷80	2,800	6	1	1A731 00 0 00 PB			
						• Version with Booster Plus item 1.07022.10.0	50÷80	2,800	6	1	1A731 00 0 00 PC			
						• Galvanized version • Welding plate and striker spacer • Inside button • Hold-open device • Galvanized protective case	50÷80	2,800	1	1	1A731 00 0 79			

Type	Description	Cylinder	Throws	Backset	Unit weight Kg	Pieces	ITEM				
							Type	Dim.	Hand	Fin.	Pers.

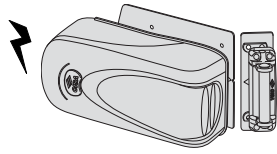

- Inner push-button
- SUPPLIED AS STANDARD:
 - Striker
 - Weld plate
 - Weld striker spacer
 - Strike spacer set (2pcs)
 - Fixing screws
 - Keys item 1.01070.10.1
 - Instruction sheet



Art.
1 06200 55 0 Fin.12

50÷80 2,780 6 1 1A611 00 0 00 DF

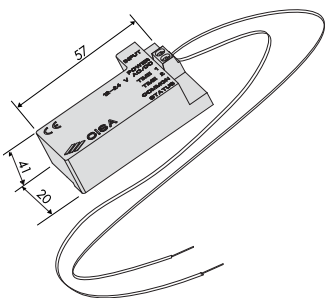
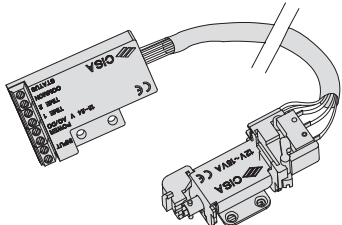
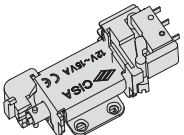
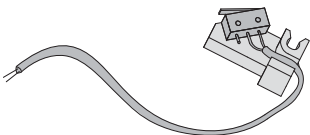
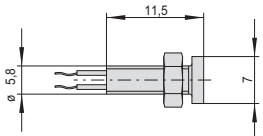
Type	Description	Unit weight Kg	Pieces	ITEM			
				Type	Dim.	Hand	Fin.
	<ul style="list-style-type: none"> • Booster device may be combined with ElettriKa rim lock to have the following function: Tension adaptor for tension different from 12 V ac (12 Vdc - 24 Vac - 24Vdc) Electrical input reduction Undersized power supply Electric hold open device (ElettriKa only) • Supplied as standard: Fixing screws Instructions sheet • Please note: Booster device may be combined also with all electric locks (electric striker included) 	0,085	1	1	07022	00	0
	<ul style="list-style-type: none"> • Booster Plus device may be combined with ElettriKa rim lock to have the following function: Electronic opening timer with 5 different options (120 sec default) Door condition signal Electric hold open device Tension adaptor for tension different from 12 V ac (12 Vdc - 24 Vac - 24Vdc) Electrical input reduction Undersized power supply • Supplied as standard: Pin to deactivate hold open catch Fixing screws Instructions sheet • ON REQUEST: Open door indicator item 1.07126.01.0 	0,185	1	1	07022	10	0
	<ul style="list-style-type: none"> • Coil for BTicino intercommunication system audio • Swing ref. 344702-03-04 • Video intercommunication system video Swing ref. 344802-03-04 combined with ElettriKa rim lock give door control signal • Supplied as standard: Fixing screws Instructions sheet 	0,092	1	1	07025	10	0
	<ul style="list-style-type: none"> • Microswitch Give a signal to operate ration motor may be installed directly on the ElettriKa rim lock • Supplied as standard: instruction sheet 	0,007	1	1	07023	00	0
	<ul style="list-style-type: none"> • Open door indicator 	0,005	1	1	07126	01	0



Technical features:

- Steel case and striker, painted aluminium grey
- Dead-locking latch
- Variable backset from 50 to 80 mm
- External cylinder length: 55 mm., nickel plated
- Current absorption 2,5 A

Supplied as standard:

- Striker
- Instruction sheet
- Fixing screws
- 3 keys item 1.01070.10.1

On request:

- Booster module item 1.07022.00.0

Certifications:

- This electric lock series is certified according to the European standard EN 14846:08:







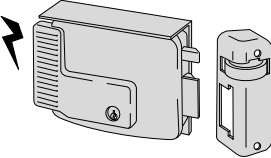

| 3 | C | 2 | 0 | 0 | M | 3 | 0 | 2 |

Security degree 3

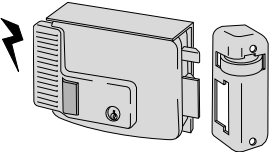
(500 Kg lateral push resistance and 200 Kg front push resistance)

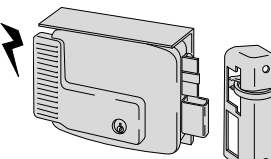
Hand:

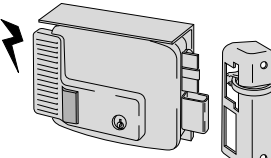
- 1 = R.H. inwards
- 2 = L.H. inwards
- 3 = R.H. outwards
- 4 = L.H. outwards

Type	Description	Cylinder	Throws	Backset	Unit weight	Pieces	ITEM			
							Type	Dim.	Hand	Fin.
 <ul style="list-style-type: none"> • Protective back plate • Spacer 	 <p>Art. 1 02139 00 0 12</p>	50	2,140	5	1	11721	50	1	N7	
		50	2,140	5	1	11721	50	2	N7	
		60	2,140	5	1	11721	60	1	N7	
		60	2,140	5	1	11721	60	2	N7	
		70	2,140	5	1	11721	70	1	N7	
		70	2,140	5	1	11721	70	2	N7	
		80	2,140	5	1	11721	80	1	N7	
		80	2,140	5	1	11721	80	2	N7	
 <ul style="list-style-type: none"> • Protective back plate • Spacer • Push-button inside and cylinder • Hold-open device 	 <p>Art. 1 02110 00 0 12</p>	50	2,180	5	1	11731	50	1	N7	
		50	2,180	5	1	11731	50	2	N7	
		60	2,180	5	1	11731	60	1	N7	
		60	2,180	5	1	11731	60	2	N7	
		70	2,180	5	1	11731	70	1	N7	
		70	2,180	5	1	11731	70	2	N7	
		80	2,180	5	1	11731	80	1	N7	
		80	2,180	5	1	11731	80	2	N7	
 <ul style="list-style-type: none"> • Manual throw deadbolt • Protective back plate • Spacer 	 <p>Art. 1 02145 00 0 12</p>	2	50	2,200	1	11761	50	1	N7	
		2	50	2,200	1	11761	50	2	N7	
		2	60	2,200	1	11761	60	1	N7	
		2	60	2,200	1	11761	60	2	N7	
		2	70	2,200	1	11761	70	1	N7	
		2	70	2,200	1	11761	70	2	N7	
 <ul style="list-style-type: none"> • Manual throw deadbolt • Protective back plate • Spacer • Push-button inside and cylinder 	 <p>Art. 1 02145 00 0 12</p>	2	50	2,230	1	11771	50	1	N7	
		2	50	2,230	1	11771	50	2	N7	
		2	60	2,230	1	11771	60	1	N7	
		2	60	2,230	1	11771	60	2	N7	
		2	70	2,230	1	11771	70	1	N7	
		2	70	2,230	1	11771	70	2	N7	

Type	Description	Cylinder	Throws	Backset	Unit weight 	Pieces 	ITEM				
							Type	Dim.	Hand	Fin.	Pers. Spec.

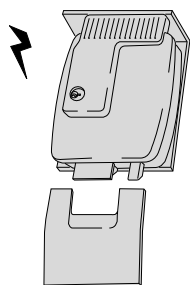

- For automated and up-and-over gates
- Protective back plate
- External cylinder length: 70 mm.

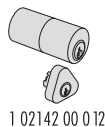

Art. 1 02142 00 0 12

80	2,100	1	1	11823	80	1	N7			
80	2,100	1	1	11823	80	2	N7			

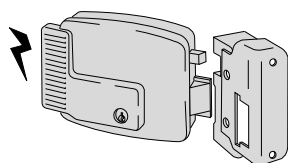

- FOR OUTWARD OPENING GATES



Art. 1 02139 00 0 12

50	1,450	1	1	11921	50	3	N7			
50	1,450	1	1	11921	50	4	N7			
60	1,450	1	1	11921	60	3	N7			
60	1,450	1	1	11921	60	4	N7			
70	1,450	1	1	11921	70	3	N7			
70	1,450	1	1	11921	70	4	N7			
80	1,450	1	1	11921	80	3	N7			
80	1,450	1	1	11921	80	4	N7			

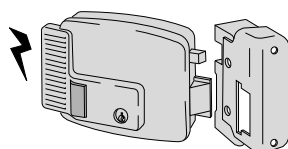

- FOR OUTWARD OPENING GATES
- Push-button
- Hold-open device



Art. 1 02110 00 0 12

50	1,470	1	1	11931	50	3	N7			
50	1,470	1	1	11931	50	4	N7			
60	1,470	1	1	11931	60	3	N7			
60	1,470	1	1	11931	60	4	N7			
70	1,470	1	1	11931	70	3	N7			
70	1,470	1	1	11931	70	4	N7			
80	1,470	1	1	11931	80	3	N7			
80	1,470	1	1	11931	80	4	N7			



Technical features:

- Zinc-plated steel case
- Steel deadbolts with 25 mm travel (for the series 41600, 41620 and 41650, 24 mm travel)
- Brass cylinder

Supplied as standard:

- 3 keys
- ITEMS 41010 - 41110 - 41111: inside: 1 key item 1.01310.00.2 outside: 2 keys item 1.01330.00.1
- ITEMS 41210 - 41220 - 41221 - 41230 - 41231 - 41310 - 41311 - 41320: inside: 1 key item 1.01310.00.2 outside: 2 keys item 1.01320.00.1
- ITEMS 41410 - 41420 - 41421: inside: 1 key item 1.01320.00.2 outside: 2 keys item 1.01330.00.1
- ITEMS 41510 - 41525 - 41526: 2 keys item 1.01060.10.0
- ITEMS 41600 - 41650: 2 keys item 1.01070.10.1
- Cylinder fixing screw (series 41620)

Hand:

- 0 = Non-handed
- 1 = R.H.
- 2 = L.H

Type	Description	Cylinder	L	A	B	S	Throws	Backset	Unit weight Kg	Pieces	ITEM					
											Type	Dim.	Hand	Fin.	Pers.	Spec.
<ul style="list-style-type: none"> • Central application 		1 02544 14 0	160	55	11,5	13,0	2	80	0,508	2	1	41010	80	0		
		1 02544 15 0	155	55	6,5	20,0	2	78	0,551	2	1	41210	78	0		
		1 02544 15 0	155	55	9,5	17,0	2	78	0,540	2	1	41320	78	0		
		1 02544 10 0	155	55	6,0	15,0	2	78	0,518	2	1	41410	78	0		
<ul style="list-style-type: none"> • Lateral application • Series 41230 with cranked deadbolt 		1 02544 14 0	120	55	11,5	15,0	2	78	0,420	2	1	41110	60	1		
		1 02544 14 0	120	55	11,5	13,0	2	60	0,424	2	1	41110	60	2		
		1 02544 15 0	155	55	6,5	20,0	2	78	0,530	2	1	41220	78	1		
		1 02544 15 0	155	55	6,5	20,0	2	78	0,530	2	1	41220	78	2		
		1 02544 15 0	155	55	6,5	20,0	2	78	0,527	2	1	41230	78	1		
		1 02544 15 0	155	55	6,5	20,0	2	78	0,527	2	1	41230	78	2		
		1 02544 15 0	155	55	9,5	17,0	2	78	0,512	2	1	41310	78	1		
		1 02544 15 0	155	55	9,5	17,0	2	78	0,512	2	1	41310	78	2		
		1 02544 10 0	155	55	6,0	15,0	2	78	0,490	2	1	41420	78	1		
		1 02544 10 0	155	55	6,0	15,0	2	78	0,498	2	1	41420	78	2		
<ul style="list-style-type: none"> • Set of side locks (1pc RH lock, 1pc LH lock) • Series 41230 with cranked deadbolt 		1 02544 14 0	120	55	11,5	13,0	2	60	0,848	1	1	41110	60	0		
		1 02544 15 0	155	55	6,5	20,0	2	78	1,060	1	1	41220	78	0		
		1 02544 15 0	155	55	6,5	20,0	2	78	1,054	1	1	41230	78	0		
		1 02544 15 0	155	55	9,5	17,0	2	78	1,024	1	1	41310	78	0		
		1 02544 10 0	155	55	6,0	15,0	2	78	0,996	1	1	41420	78	0		
	<ul style="list-style-type: none"> • Set of side locks (1pc RH lock, 1pc LH lock) • KA execution (KA) • 3 keys per each set • Series 41231 with cranked deadbolt 		1 02544 14 0	120	55	11,5	13,0	2	60	0,800	1	1	41111	60	0	
		1 02544 15 0	155	55	6,5	20,0	2	78	1,060	1	1	41221	78	0		
		1 02544 15 0	155	55	6,5	20,0	2	78	1,054	1	1	41231	78	0		
		1 02544 15 0	155	55	9,5	17,0	2	78	1,024	1	1	41311	78	0		
		1 02544 10 0	155	55	6,0	15,0	2	78	0,940	1	1	41421	78	0		

Type	Description	Cylinder	Cylinder				Throws	Backset	Unit weight 	Pieces 	ITEM					
			L	A	B	S					Type	Dim.	Hand	Fin.	Pers. Spec.	
 	<ul style="list-style-type: none"> • Deadbolt stroke 25 mm • Central lock • Straight deadbolt • 2 pins dia. 9 mm 	155	55	5,5	15,0	2	78	0,525	12	1	41510	78	0			
	<ul style="list-style-type: none"> • Version with fixing plate assembled • Central application • Straight deadbolt • 2 pins dia. 9 mm 	155	55	5,5	15,0	2	78	0,518	12	1	41510	78	0	00	ZQ	
 	<ul style="list-style-type: none"> • Lateral application • Bent deadbolt • 1 pins dia. 9 mm 	155	55	5,5	15,0	2	78	0,445	12	1	41525	78	1			
		155	55	5,5	15,0	2	78	0,490	12	1	41525	78	2			
 	<ul style="list-style-type: none"> • Set of side locks (1pc RH lock, 1pc LH lock) • Bent deadbolt • 2 pins dia. 9 mm 	155	55	5,5	15,0	2	78	0,800	6	1	41525	78	0			
	<ul style="list-style-type: none"> • Set of side locks (1pc RH lock, 1pc LH lock) • Bent deadbolt • Keyed alike (KA) • 3 keys per pair • 2 pins dia. 9 mms 	155	55	5,5	15,0	2	78	0,875	6	1	41526	78	0			

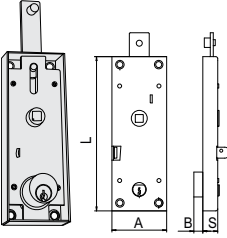
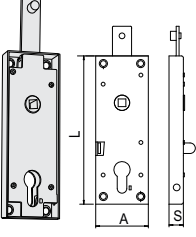
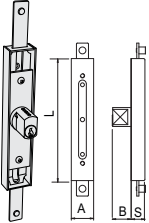
Type	Description	Cylinder	Cylinder				Throws	Backset	Unit weight Kg	Pieces	ITEM						
			L	A	B	S					Type	Dim.	Hand	Fin.	Pers.	Spec.	
	<ul style="list-style-type: none"> • FOR SWING DOORS • Top lock • OPERATION: from the inside and the outside: opening via the handle, from the outside: key locking, from the inside: lever unlocking 		155	55	15,0	1		0,462	12	1	41600	00	0				
	<ul style="list-style-type: none"> • FOR SWING DOORS • Top lock • European profile cylinders to order separately • OPERATION: from the inside and the outside: opening via the handle, from the outside: key locking, from the inside: lever unlocking • ON REQUEST: Cylinder fixing screws 		155	55	15,0	1		0,383	12	1	41620	00	0				
	<ul style="list-style-type: none"> • FOR EXTENSIBLE GATES • Top and bottom locks • European profile cylinders to order separately 		102	26	22,0	16,0	2	68	0,300	12	1	41650	00	0			



Technical features:

- Zinc-plated steel case
- Zinc-plated steel faceplate
- Steel deadbolt



Supplied as standard:



- Cylinder fixing screws (for versions with European profile cylinders)

Hand:
0 = Non-handed

Cylinder to be ordered separately

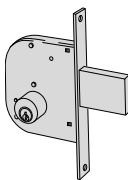
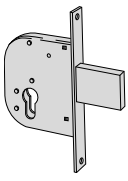
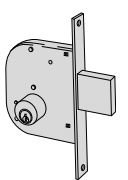
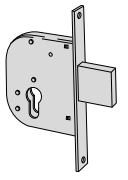
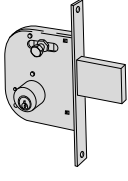
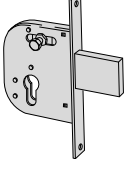

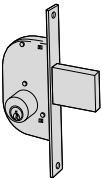
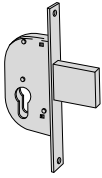
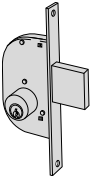
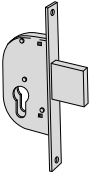
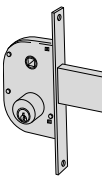
Type	Description	Throws	Centre Distance	Faceplate	Backset	Unit weight 	Pieces 	ITEM			
								Type	Dim.	Hand	Fin. Pars. Spec.
	<ul style="list-style-type: none"> • Latch with built-in deadbolt • Pair of cylinders item 1.02156.00.0 • 3 keys item 1.01330.00.1 	1	22	50	0,789	2	1	42010	50	0	
	<ul style="list-style-type: none"> • Latch with built-in deadbolt 	1	22	50	0,609	2	1	42012	50	0	
	<ul style="list-style-type: none"> • deadbolt only • Pair of cylinders item 1.02156.00.0 • 3 keys item 1.01330.00.1 	2	22	50	0,735	2	1	42020	50	0	
	<ul style="list-style-type: none"> • deadbolt only 	2	22	50	0,550	2	1	42022	50	0	
	<ul style="list-style-type: none"> • Non-handed • Latch with built-in deadbolt • Inside knob • Pair of cylinders item 1.02156.00.0 • 3 keys item 1.01330.00.1 	1	22	50	0,804	2	1	42030	50	0	
	<ul style="list-style-type: none"> • Non-handed • Latch with built-in deadbolt • Inside knob 	1	22	50	0,607	2	1	42032	50	0	

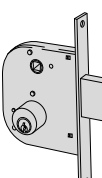
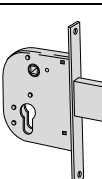
Type	Description	Throws	Centre Distance	Faceplate Backset	Unit weight Kg	Pieces	ITEM				
							Type	Dim.	Hand	Fin.	Pers. Spec.
	<ul style="list-style-type: none"> • Latch-bolt only • Pair of cylinders item 1.02156.00.0 • 3 keys item 1.01330.00.1 	22	30	0,657	2	1	42110	30	0		
	<ul style="list-style-type: none"> • Latch-bolt only 	22	30	0,470	2	1	42112	30	0		
	<ul style="list-style-type: none"> • Latch-bolt only • Pair of cylinders item 1.02156.00.0 • 3 keys item 1.01330.00.1 	1	22	30	0,620	2	1	42120	30	0	
	<ul style="list-style-type: none"> • deadbolt only 	1	22	30	0,425	2	1	42122	30	0	
	<ul style="list-style-type: none"> • Latch with dead-locking device • Through spindle • Pair of cylinders item 1.02156.00.0 • 3 keys item 1.01330.00.1 	42	22	30	0,713	2	1	42210	30	0	
	<ul style="list-style-type: none"> • Latch with dead-locking device • Through spindle 	42	22	30	0,520	2	1	42212	30	0	
	<ul style="list-style-type: none"> • Latch with dead-locking device • Through spindle • Pair of cylinders item 1.02156.00.0 • 3 keys item 1.01330.00.1 	1	42	22	50	0,832	2	1	42310	50	0
	<ul style="list-style-type: none"> • Latch with dead-locking device • Through spindle 	1	42	22	50	0,650	2	1	42312	50	0

Type	Description	Throws	Centre Distance	Faceplate	Backset	Unit weight 	Pieces 	ITEM			
								Type	Dim.	Hand	Fin.
	<ul style="list-style-type: none"> • Latch and deadbolt (the latch is withdrawn by key and handle) • Through spindle • Pair of cylinders item 1.02156.00.0 • 3 keys item 1.01330.00.1 	1	57	22	30	0,853	2	1	42410	30	0
	<ul style="list-style-type: none"> • Latch and deadbolt (the latch is withdrawn by key and handle) • Through spindle 	1	57	22	30	0,671	2	1	42412	30	0
	<ul style="list-style-type: none"> • Latch and deadbolt (the latch is withdrawn by key and handle) • Through spindle • Pair of cylinders item 1.02156.00.0 • 3 keys item 1.01330.00.1 	2	57	22	30	0,724	2	1	42420	30	0
	<ul style="list-style-type: none"> • Latch and deadbolt (the latch is withdrawn by key and handle) • Through spindle 	2	57	22	30	0,538	2	1	42422	30	0
	<ul style="list-style-type: none"> • Latch and deadbolt (the latch is withdrawn by key and handle) • Through spindle • Pair of cylinders item 1.02156.00.0 • 3 keys item 1.01330.00.1 	2	57	22	50	1,018	2	1	42510	50	0
	<ul style="list-style-type: none"> • Latch and deadbolt (the latch is withdrawn by key and handle) • Through spindle 	2	57	22	50	0,825	2	1	42512	50	0



Technical features:

- Steel case
- Steel faceplate
- Lamellar steel deadbolt protected by single throw armour plating
- Deadbolt resistance equivalent to Grade 3 Security of the European Standard EN 12209:03
 - Side load resistance: 1,000 kg (equivalent to highest grade according to the above Standard)
 - Resistance to blows from below: 400 kg
- Suitable for doors certified to EN 1627:2021 up to WK/RC 2 resistance class
- 13 mm driving gears stroke for additional locking points
- Spindle for operating the deadbolt and driving gears

Supplied as standard:

- Cylinder fixing screws

Finishes:

- Zinc-plated case
- Zinc-plated faceplate
- Zinc-plated deadbolt

Hand:

0 = Non-handed

Cylinder to be ordered separately



0G303, 0G305, 0E303, 0E305

Type	Description	Throws	Centre Distance	Faceplate	Backset	Unit weight	Pieces	ITEM				
								Type	Dim.	Hand	Fin.	Pers. Spec.



- Latch bolt only
- CAN BE USED WITH THE FOLLOWING ACCESSORIES:
European profile cylinders with special cam:
Item 1.0G305.02.0.12 (C2000 single cylinder)
Item 1.0G303.07.0.12 (C2000 double cylinder)
Item 1.0E305.02.0.12 (ASIX single cylinder)
Item 1.0E303.07.0.12 (ASIX double cylinder)
Handle item 1.06003.00.0
Handle with edge cover item 1.06004.00.0
Striker item 1.06232.21.0
Adjustable striker item 1.06232.22.0
Screwed extension bolts item 1.07088.03.0

1	59	25	19,7	0,590	24	1	46305	19	0				
1	59	25	25,7	0,672	24	1	46305	25	0				
1	59	25	31	0,780	24	1	46305	30	0				

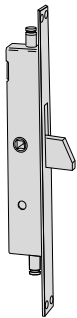

- Deadbolt only
- Pin key cylinder complete with 2 pieces item 1.00210.00.0 (KA 1 version, key included)
- CAN BE USED WITH THE FOLLOWING ACCESSORIES:
Handle item 1.06003.01.0
Handle with edge cover item 1.06004.01.0
Striker item 1.06232.21.0
Adjustable striker item 1.06232.22.0
Extension bolts item 1.07088.03.0

1	59	25	19,7	0,709	24	1	46307	19	0				
1	59	25	25,7	0,804	24	1	46307	25	0				



Technical features:

- Extended bolts 25 mm
- Stainless steel faceplate
- Zinc-plated steel case
- 8 mm square spindle
- Pre-set for additional locking points

Operation:

- The handle operates both the swinging deadbolt and the extension bolt, bringing them in the locking position; the key blocks the handle

Supplied as standard:

- Pair of threaded bushings (M8) item 1.06290.10.0
- Pair of bushings for quick-lock system (series 46303)
- Cylinder fixing screws
- Instruction sheet

Certifications:



- This lock series is certified to EN 12209:16 grade 3 Security (500 Kg side load and 400 Kg upward force)
- Suitable for doors certified to EN 1627:2021 up to resistance class WK/RC 2

• Series 46800, 46803
| 3 | C | 9 | 0 | 0 | F | 3 | B |

• Series 46875, 46878
| 3 | C | 9 | 0 | 0 | F | - | B |

Hand:
0 = Non-handed

Cylinder to be ordered separately

Type	Description	Throws	Centre Distance	Faceplate	Backset	Unit weight Kg	Pieces	ITEM			
								Type	Dim.	Hand	Fin.

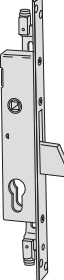

- Nickel-plated deadbolt
- Zinc plated steel inside rose item 1.06092.00.0
- Pre-set for additional locking points with threaded bushings M8
- ON REQUEST:
Extension bolts item 1.07088.03.0
Cylinder with pin key item 1.02400.10.0
Floor striker item 1.06086.00.0
Floor striker with dust cover item 1.06086.02.0
Zinc plated striker item 1.06232.21.0

1	85	25	25	0,590	12	1	46800	25	0			
1	85	25	30	0,610	12	1	46800	30	0			
1	85	25	35	0,630	12	1	46800	35	0	00	00	RB

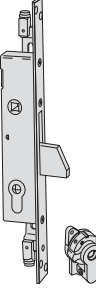

- Nickel-plated deadbolt
- Inside steel rose item 1.06092.00.0
- Pre-set for additional locking points with quick-lock bushings
- ON REQUEST:
Extension bolts item 1.07088.04.0.00.CG (without tips) or item 1.07088.04.0 (with dia. 10 mm pins)
Cylinder with pin key item 1.02400.10.0
Floor striker item 1.06086.00.0
Floor striker with dust cover item 1.06086.02.0
Zinc plated steel striker item 1.06232.21.0

1	85	25	25	0,590	12	1	46803	25	0			
1	85	25	30	0,610	12	1	46803	30	0			
1	85	25	35	0,630	12	1	46803	35	0			



- Nickel-plated deadbolt
- Cross-key cylinder with 3 keys
- Inside steel rose item 1.06002.00.0
- Pre-set for additional locking points with threaded bushings
- ON REQUEST:
Extension bolts item 1.07088.03.0
Cylinder with pin key item 1.02400.10.0
Floor striker item 1.06086.00.0
Floor striker with dust cover item 1.06086.02.0
Zinc plated steel striker item 1.06232.21.0

1	85	25	25	0,710	12	1	46802	25	0			
1	85	25	30	0,730	12	1	46802	30	0			
1	85	25	35	0,750	12	1	46802	35	0			

Type	Description	Throws	Centre Distance	Faceplate	Backset	Unit weight Kg	Pieces	ITEM				
								Type	Dim.	Hand	Fin.	Pers. Spec.
 <ul style="list-style-type: none"> Nickel-plated metal hook, 7.5 mm gap Inside steel rose item 1.06092.00.0 Zinc plated steel striker item 1.06232.21.0 Pre-set for additional locking points with threaded bushings ON REQUEST: Extension bolts item 1.07088.03.0 Cylinder with pin key item 1.02400.10.0 Floor striker item 1.06086.00.0 Floor striker with dust cover item 1.06086.02.0 	1	85	25	25	0,650	12	1	46865	25	0		
	1	85	25	30	0,670	12	1	46865	30	0		
	1	85	25	35	0,690	12	1	46865	35	0		
 <ul style="list-style-type: none"> Top/bottom locking point Inside steel rose item 1.06092.00.0 Pre-set for additional locking points with threaded bushings ON REQUEST: Extension bolts item 1.07088.03.0 Cylinder with pin key item 1.02400.10.0 Floor striker item 1.06086.00.0 Floor striker with dust cover item 1.06086.02.0 	85	25	25	0,570	12	1	46875	25	0			
	85	25	30	0,590	12	1	46875	30	0			
	85	25	35	0,610	12	1	46875	35	0			
 <ul style="list-style-type: none"> Top/bottom locking point Inside steel escutcheon item 1 06092.00.0 Pre-set for additional locking points with quick-lock bushings ON REQUEST: Quick-lock bolt extension rods item 1.07088.04.0.00.CG (without pins) or item 1.07088.04.0 (with dia 10 mm pins) Cylinder with pin key item 1.02400.10.0 Floor striker item 1.06086.00.0 Floor striker with dust cover item 1.06086.02.0 	85	25	25	0,570	12	1	46878	25	0			
	85	25	30	0,590	12	1	46878	30	0			
	85	25	35	0,610	12	1	46878	35	0			

Technical features:

- Extended bolts 25 mm (mechanical version)
- Zinc-plated steel case
- Stainless steel faceplate
- Nickel-plated deadbolt
- Reversible latch bolt (where present)
- 8 mm square spindle
- Current absorption 3.1 A electric version
- Power supply 12V ac

Supplied as standard:

- Cylinder fixing screws
- Instruction sheet

On request:

- Protective rose for cylinder, item 1.06460.00.0

Certification:

- This lock series is certified according to the European standard EN 12209:16

46820, 46823, 46815, 46825 series
| 3 | C | 9 | 0 | 0 | F | 3 | B |

46870, 46873 series
| 3 | C | 9 | 0 | 0 | F | - | B |

- Security degree 3 (500 Kg lateral push resistance and 400 Kg upward push resistance)

- Suitable for doors certified to EN 1627:2021 up to WK/RC 2 resistance class

Hand:
0 = Non-handed

Cylinder to be ordered separately



Type	Description	Throws	Centre Distance	Faceplate	Backset	Unit weight 	Pieces 	ITEM			
								Type	Dim.	Hand	Fin.

	<ul style="list-style-type: none"> • Deadbolt and latch • 10.5 to 16.5 mm. adjustable latch and piston • Set of steel roses item 1.06092.00.0 • Pre-set for additional locking points • Pair of threaded bushings (M8) item 1.06290.05.0 • Threaded pivots for fixing extension bolts • ON REQUEST: Extension bolts item 1.06441.15.0 Extension bolts item 1.07088.03.0 Floor striker item 1.06086.00.0 Floor striker with dust cover item 1.06086.02.0 Striker item 1.06232.20.0 	1	85	25	25	0,931	12	1	16325	25	0
		1	85	25	30	0,967	12	1	16325	30	0
		1	85	25	35	0,950	12	1	16325	35	0

	<ul style="list-style-type: none"> • Nickel-plated deadbolt and latchbolt, 11 to 17 mm adjustable reversible latchbolt • Set of steel roses item 1.06092.00.0 • ON REQUEST: Striker item 1.06232.20.0 Cross-key cylinder item 1.02400.10.0 	1	85	25	25	0,630	12	1	46815	25	0
		1	85	25	30	0,650	12	1	46815	30	0
		1	85	25	35	0,670	12	1	46815	35	0

	<ul style="list-style-type: none"> • Nickel-plated deadbolt • Set of steel roses item 1.06092.00.0 • Pre-set for additional locking points with threaded bushings • ON REQUEST: Extension bolts item 1.07088.03.0 Cylinder with pin key item 1.02400.10.0 Floor striker item 1.06086.00.0 Floor striker with dust cover item 1.06086.02.0 Striker item 1.06232.21.0 	1	25	25	25	0,550	12	1	46820	25	0
		1	25	30	30	0,570	12	1	46820	30	0
		1	25	35	35	0,590	12	1	46820	35	0

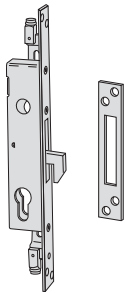
Type	Description	Throws	Centre Distance	Faceplate	Backset	Unit weight Kg	Pieces	ITEM				
								Type	Dim.	Hand	Fin.	Pers. Spec.
	<ul style="list-style-type: none"> Nickel-plated deadbolt Cross-key cylinder with 3 keys Pre-set for additional locking points with threaded bushings Set of nylon rose item 1.06002.00.0 ON REQUEST: Extension bolts item 1.07088.03.0 Floor striker item 1.06086.00.0 Floor striker with dust cover item 1.06086.02.0 Striker item 1.06232.21.0 	1	25	25	0,670	12	1	46822	25	0		
		1	25	30	0,690	12	1	46822	30	0		
		1	25	35	0,710	12	1	46822	35	0		
	<ul style="list-style-type: none"> Nickel-plated deadbolt Inside steel escutcheon item 1.06092.00.0 Pre-set for additional locking points with quick-lock bushings ON REQUEST: Quick-lock bolt extension rods item 1.07088.04.0.00.CG (without pins) or item 1.07088.04.0 (with dia 10 mm pins) Cylinder with pin key item 1.02400.10.0 Floor striker item 1.06086.00.0 Floor striker with dust cover item 1.06086.02.0 Striker item 1.06232.21.0 	1	25	25	0,550	12	1	46823	25	0		
		1	25	30	0,570	12	1	46823	30	0		
		1	25	35	0,590	12	1	46823	35	0		
	<ul style="list-style-type: none"> Nickel-plated deadbolt and latchbolt, 11 to 17 mm adjustable reversible latchbolt Set of steel rose item 1.06092.00.0 Pre-set for additional locking points with threaded bushings ON REQUEST: Extension bolts item 1.07088.03.0 Cylinder with pin key item 1.02400.10.0 Floor striker item 1.06086.00.0 Floor striker with dust cover item 1.06086.02.0 Striker item 1.06232.20.0 	1	85	25	25	0,650	12	1	46825	25	0	
		1	85	25	30	0,670	12	1	46825	30	0	
		1	85	25	35	0,690	12	1	46825	35	0	
	<ul style="list-style-type: none"> Nickel-plated deadbolt and latchbolt, 11 to 17 mm adjustable reversible latchbolt Cross-key cylinder with 3 keys Set of nylon rose item 1.06002.00.0 Pre-set for additional locking points with threaded bushings ON REQUEST: Extension bolts item 1.07088.03.0 Floor striker item 1.06086.00.0 Floor striker with dust cover item 1.06086.02.0 Striker item 1.06232.20.0 	1	85	25	25	0,770	12	1	46827	25	0	
		1	85	25	30	0,762	12	1	46827	30	0	
		1	85	25	35	0,810	12	1	46827	35	0	

Type	Description	Throws	Centre Distance	Faceplate	Backset	Unit weight 	Pieces 	ITEM				
								Type	Dim.	Hand	Fin.	Pers. Spec.
 <ul style="list-style-type: none"> Nickel-plated laminar steel hook, 7.5 mm gap Inside steel escutcheon item 1.06092.00.0 Pre-set for additional locking points with threaded bushings Striker item 1.06232.21.0 ON REQUEST: <ul style="list-style-type: none"> Extension bolts item 1.07088.03.0 Cylinder with pin key item 1.02400.10.0 Floor striker item 1.06086.00.0 Floor striker with dust cover item 1.06086.02.0 	1	25	25	0,610	12	1	46860 25 0					
	1	25	30	0,630	12	1	46860 30 0					
	1	25	35	0,650	12	1	46860 35 0					
 <ul style="list-style-type: none"> Top/bottom locking point Inside steel escutcheon item 1.06092.00.0 Pre-set for additional locking points with threaded bushings ON REQUEST: <ul style="list-style-type: none"> Extension bolts item 1.07088.03.0 Cylinder with pin key item 1.02400.10.0 Floor striker item 1.06086.00.0 Floor striker with dust cover item 1.06086.02.0 	1	25	25	0,530	12	1	46870 25 0					
	1	25	30	0,550	12	1	46870 30 0					
	1	25	35	0,570	12	1	46870 35 0					
 <ul style="list-style-type: none"> Top/bottom locking point Inside steel escutcheon item 1.06092.00.0 Pre-set for additional locking points with quick-lock bushings ON REQUEST: <ul style="list-style-type: none"> Extension bolts item 1.07088.03.0 Cylinder with pin key item 1.02400.10.0 Floor striker item 1.06086.00.0 Floor striker with dust cover item 1.06086.02.0 	1	25	25	0,530	12	1	46873 25 0					
	1	25	30	0,550	12	1	46873 30 0					
	1	25	35	0,570	12	1	46873 35 0					

Zinc plated version fin. 79



Grey powder coated version fin. 95



Technical features:

- Steel case and striker
- Brass latch and deadbolt
- Brass draw-back pull and thumb turn
- External cylinder length 55 mm

Hand:

- 1 = R.H. inwards
- 2 = L.H. inwards

Supplied as standard:

- Striker
- Fixing screws
- 3 keys item 1.01070.10.1





Finishes:

- Zinc-plated case and striker fin. 79
- Aluminium-grey powder coated case and striker fin. 95

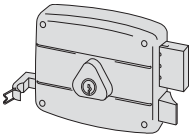
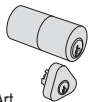
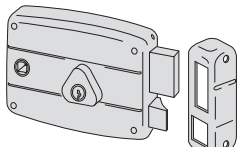
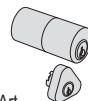
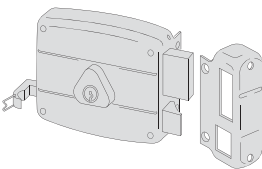
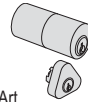
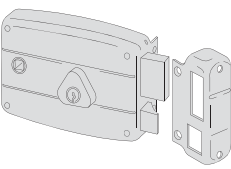
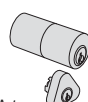
On request:

- Protective back plate and striker spacer item 1.07061.10.0

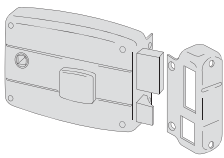
Type	Description	Cylinder	Throws	Backset	Unit weight 	Pieces 	ITEM				
							Type	Dim.	Hand	Fin.	Pers. Spec.
 <ul style="list-style-type: none"> • Without fixing tongue • Inside draw-back pull • Latch and deadbolt • Hold open device • FINISHES <ul style="list-style-type: none"> - Zinc-plated case and striker - Brass latch, deadbolt, cylinder and draw-back pull 	 Art. 1 02106 00 0	2	60	0,990	1	1	50521	60	1	79	
		2	60	0,990	1	1	50521	60	2	79	
		2	70	1,120	1	1	50521	70	1	79	
		2	70	1,120	1	1	50521	70	2	79	
 <ul style="list-style-type: none"> • Without fixing tongue • 8 mm through spindle • Latch and deadbolt • FINISHES <ul style="list-style-type: none"> - Zinc-plated case and striker - Brass latch, deadbolt and cylinder. 	 Art. 1 02106 00 0	2	60	0,990	10	1	50571	60	1	79	
		2	60	0,990	10	1	50571	60	2	79	
 <ul style="list-style-type: none"> • With fixing tongue • Inside draw-back pull • Hold open device • FINISHES <ul style="list-style-type: none"> - aluminium-grey powder coated case and striker - nickel-plated latch, deadbolt, cylinder and draw back pull 	 Art. 1 02106 00 0 12	2	50	0,956	1	1	50421	50	1	95	
		2	50	0,956	1	1	50421	50	2	95	
		3	60	0,990	1	1	50421	60	1	95	
		3	60	0,990	1	1	50421	60	2	95	
		3	70	1,120	1	1	50421	70	1	95	
		3	70	1,120	1	1	50421	70	2	95	
 <ul style="list-style-type: none"> • With fixing tongue • Through spindle • 8 mm through spindle • Latch and deadbolt • FINISHES <ul style="list-style-type: none"> - aluminium-grey powder coated case and striker - nickel-plated latch, deadbolt and cylinder. 	 Art. 1 02106 00 0 12	2	60	0,990	1	1	50471	60	1	95	
		2	60	0,990	1	1	50471	60	2	95	

Type	Description	Cylinder	Throws	Backset	Unit weight 	Pieces 	ITEM				
							Type	Dim.	Hand	Fin.	Pers.
	<ul style="list-style-type: none"> • With fixing tongue • Internal/inside thumb turn • 8 mm through spindle • Deadbolt and latch • FINISHES <ul style="list-style-type: none"> - aluminium-grey powder coated case and striker - nickel-plated latch, deadbolt and thumb turn 		2	60	0,990	1	1	50481	60	1	95
							1	50481	60	2	95
		Art. 1 0G200 55 0 12									



Technical features:

- Nickel-plated steel case and plate
- Nickel-plated ground steel deadbolt
- Nickel-plated steel thumb turns
- Nickel-plated cylinder length 50mm

Hand:

1=R.H.
inwards

Supplied as standard:

- 3 keys item 1.01070.10.1

Type	Description	Cylinder	Throws	Backset	Unit weight 	 Pieces	ITEM			
							Type	Dim.	Hand	Fin. Pers. Spec.
	• Deadbolt only		6	50	1,125	12	1	55254	50	1
			6	60	1,160	12	1	55254	60	1
	• Deadbolt with built-in latchbolt		6	50	0,950	12	1	55274	50	1
			6	60	0,950	12	1	55274	60	1



Technical features:

- Zinc-plated case
- Zinc-plated faceplate
- Nickel-plated steel deadbolt
- Pre-set for protective roses

Supplied as standard:

- Inside steel escutcheon item 1.06075.00.0
- Cylinder fixing screws
- Instruction sheet

On request:

- Zinc-plated, steel striker item 1.06232.00.0
- Protective rose for cylinder, item 1.06460-50/51/60-0

Hand:

0 = Non-handed

Cylinder to be ordered separately



Type	Description	Throws	Centre Distance	Faceplate	Backset	Unit weight 		ITEM			
								Type	Dim.	Hand	Fin.

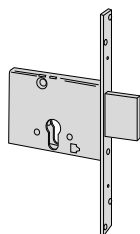

- Case height 82 mm.

3	25	52	0,600	12	1 56013 50 0
3	25	60	0,657	12	1 56013 60 0
3	25	70	0,697	12	1 56013 70 0

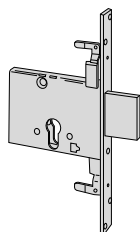

- Case height 82 mm.
- Pre-set for additional locking points
- Pair of threaded bushings (M8) item 1.06290.10.0
- ON REQUEST:
 Extension bolts item 1.06415.00.0
 Extension bolts item 1.07088.03.0
 Floor striker item 1.06086.00.0
 Floor striker with dust cover item 1.06086.02.0

3	25	60	0,720	12	1 56016 60 0
3	25	70	0,792	12	1 56016 70 0



Technical features:

- Galvanized steel case, height 64 mm
- Galvanized steel faceplate
- Adjustable latchbolt, 11 to 17 mm
- 3-throw deadbolt, 11 mm
- Square spindle, 8 mm
- Cylinder fixing via lock internal screw

Supplied as standard:

- Threaded fixing pins for bushings and extension bolts, item 1.06449.05.0
- Pair of steel roses item 1.06075.00.0
- Pair of threaded bushings (M8) item 1.06290.05.0
- Instruction sheet
- Fixing screws

On request:

- Adjustable metal striker plates
- Modular roller assembly item 1.06168.00.0
- Nylon rose item 1.06141.56.0 ensuring interchangeability with series 57300
- Cylinder protective rose item 06460.05.50/51/60.0

Cylinder to be ordered separately



Type	Description	Throws	Centre Distance	Faceplate	Backset	Unit weight 	Pieces 	ITEM				
								Type	Dim.	Hand	Fin.	Pers. Spec.

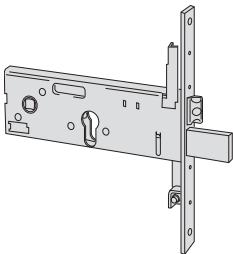

- Nickel-plated steel faceplate 25x3 mm
- Reversible latch and deadbolt
- ON REQUEST:
"MODULAR" roller assembly item 1.06168.00.0
Floor striker item 1.06086.00/02.0
Zinc-plated steel striker item 1.06232.01.0 or item 1.06232.00.0
Cylinder protective rose item 106460.05/50/51/60
Rose for locks series 57300 item 1.06141.56.0 or item 1.06473.00.0
Extension bolts item 1.06441.15.0
Extension bolts with screws item 1.07088.03/05.0

3	67	25	90	0,930	12	1	56358	90	0		
3	67	25	100	0,930	12	1	56358	10	0		

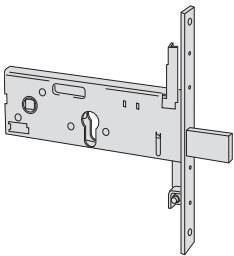

- Stainless steel faceplate 25x3 mm
- Deadbolt only
- ON REQUEST:
Floor striker item 1.06086.00/02.0
Zinc-plated steel striker item 1.06232.00.0
Cylinder protective rose item 106460.05/50/51/60
Extension bolts item 1.06441.15.0
Extension bolts with screws item 1.07088.03/05.0

3	-	25	110	0,995	12	1	56378	11	0		
---	---	----	-----	-------	----	---	-------	----	---	--	--



- MODULAR roller assembly for locks series 56358

					0,040	12	1	06168	00	0	
--	--	--	--	--	-------	----	---	-------	----	---	--



Technical features:

- Zinc-plated case
- Zinc-plated faceplate
- Nickel-plated steel deadbolt

Hand:

0 = Non-handed

Supplied as standard:

- Inside steel escutcheon item 1.06124.02.0
- Instruction sheet

On request:

- Zinc-plated steel striker item 1.06232.00.0

Type	Description	Key item	Throws	Centre Distance	Faceplate	Backset	Unit weight 	Pieces	ITEM			
									Type	Dim.	Hand	Fin.

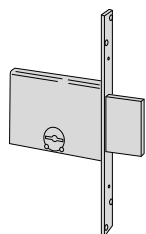

- Case height 82 mm.
- 2 keys



1 00100 00 1

4	25	52	0,788	12	1 57013 50 0 00 30
4	25	60	0,833	12	1 57013 60 0 00 30
4	25	70	0,868	12	1 57013 70 0 00 30

- As above, keyed alike (KA)
- 1 key



1 00100 00 1

4	25	52	0,760	12	1 57013 52 0 00 30
4	25	60	0,812	12	1 57013 62 0 00 30
4	25	70	0,833	12	1 57013 72 0 00 30

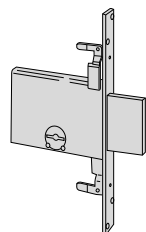

- Case height 82 mm.
- 2 keys
- Pre-set for additional locking points
- Pair of threaded bushings (M8) item 1.06290.10.0
- ON REQUEST:
Extension bolts item 1.06415.00.0
Extension bolts item 1.07088.03.0
Floor striker item 1.06086.00.0
Floor striker with dust cover item 1.06086.02.0



1 00100 00 1

4	25	60	0,940	12	1 57016 60 0
4	25	70	0,982	12	1 57016 70 0

- As above, keyed alike (KA)
- 1 key



1 00100 00 1

4	25	60	0,925	12	1 57016 62 0
4	25	70	0,963	12	1 57016 72 0

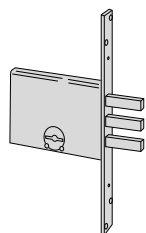

- Case height 82 mm.
- 2 keys
- deadbolt with 3 locking points



1 00100 00 1







4	25	60	0,754	12	1 57030 60 0
4	25	70	0,780	12	1 57030 70 0

- As above, keyed alike (KA)
- 1 key

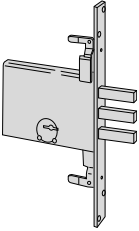

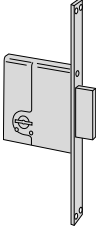
1 00100 00 1

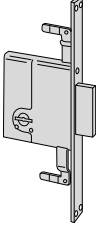
4	25	60	0,735	12	1 57030 62 0
4	25	70	0,773	12	1 57030 72 0

Type	Description	Key item	Throws	Centre Distance	Faceplate Backset	Unit weight Kg	Pieces	ITEM				
								Type	Dim.	Hand	Fin.	Pers. Spec.
	<ul style="list-style-type: none"> • Case height 82 mm. • 2 keys • deadbolt with 3 locking points • Pre-set for additional locking points • Pair of threaded bushings (M8) item 1.06290.10.0 • ON REQUEST: Extension bolts item 1.06415.00.0 Extension bolts item 1.07088.03.0 Floor striker item 1.06086.00.0 Floor striker with dust cover item 1.06086.02.0 	 1 00100 00 1	4	25	60	0,848	12	1	57035	60	0	
			4	25	70	0,919	12	1	57035	70	0	
	<ul style="list-style-type: none"> • As above, keyed alike (KA) • 1 key 	 1 00100 00 1	4	25	60	0,838	12	1	57035	62	0	
			4	25	70	0,870	12	1	57035	72	0	
	<ul style="list-style-type: none"> • Case height 93 mm. • 2 keys 	 1 00100 00 1	2	22	40	0,520	12	1	57223	40	0	
			2	22	45	0,540	12	1	57223	45	0	
			2	22	50	0,560	12	1	57223	50	0	
			2	22	60	0,592	12	1	57223	60	0	
	<ul style="list-style-type: none"> • As above, keyed alike (KA) • 1 key 	 1 00100 00 1	2	22	40	0,506	12	1	57223	42	0	
			2	22	45	0,524	12	1	57223	47	0	
			2	22	50	0,545	12	1	57223	52	0	
			2	22	60	0,578	12	1	57223	62	0	
	<ul style="list-style-type: none"> • Case height 93 mm. • 2 keys • Pre-set for additional locking points • Pair of threaded bushings (M8) item 1.06290.10.0 • ON REQUEST: Extension bolts item 1.06415.00.0 Extension bolts item 1.07088.03.0 Floor striker item 1.06086.00.0 Floor striker with dust cover item 1.06086.02.0 	 1 00100 00 1	2	25	45	0,670	12	1	57226	45	0	
			2	25	50	0,687	12	1	57226	50	0	
			2	25	60	0,730	12	1	57226	60	0	
	<ul style="list-style-type: none"> • As above, keyed alike (KA) • 1 key 	 1 00100 00 1	2	25	45	0,657	12	1	57226	47	0	
			2	25	50	0,664	12	1	57226	52	0	
			2	25	60	0,708	12	1	57226	62	0	



Technical features:

- Zinc-plated case
- Zinc-plated faceplate
- Nickel-plated steel deadbolt
- Picking resistant protection plate
- Nickel-plated latch or reversible latch/bolt
- Electrical and mechanical versions are interchangeable
- Power supply 12V
- Current absorption 1,7 A

Hand:
0 = Non-handed

Supplied as standard:

- Instruction sheet

Type	Description	Key item	Throws	Centre Distance	Faceplate	Backset	Unit weight	Pieces	ITEM			
									Type	Dim.	Hand	Fin.

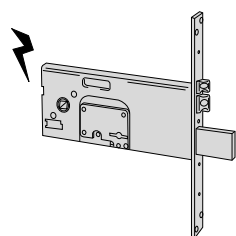

- Case height 78 mm.
- 2 keys
- deadbolt and latch
- Adjustable latch and piston
- Dead-locking latch
- Hold-open device
- Pair of steel roses item 1.06124.02.0
- ON REQUEST:
Zinc plated steel striker item 1.06232.00.0





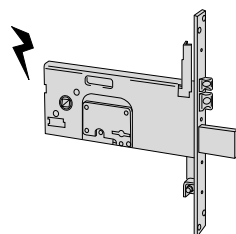





4 67 25 90 1,220 12 1 17353 90 0

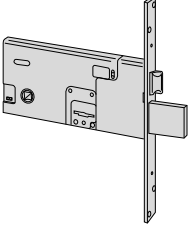

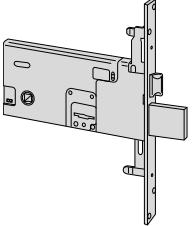
- Case height 78 mm.
- 2 keys
- deadbolt and latch
- Adjustable latch and piston
- Dead-locking latch
- Hold-open device
- Pair of steel roses item 1.06124.02.0
- Pre-set for additional locking points
- Pair of threaded bushings (M8) item 1.06290.05.0
- Threaded rods for fixing extension bolts
- ON REQUEST:
Extension bolts item 1.06441.15.0
Extension bolts item 1.07088.03.0
Floor striker item 1.06086.00.0
Floor striker with dust cover item 1.06086.02.0
Zinc plated steel striker item 1.06232.00.0

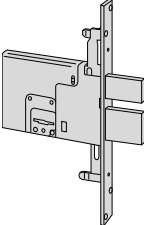

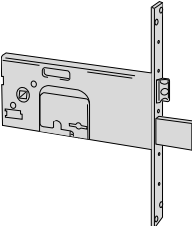
4 67 25 90 1,312 12 1 17358 90 0

Type	Description	Key item	Throws	Centre Distance	Faceplate Backset	Unit weight Kg	Pieces	ITEM					
								Type	Dim.	Hand	Fin.	Pers. Spec.	
	<ul style="list-style-type: none"> • Case height 82 mm. • 2 keys • deadbolt and latch • Inside steel rose item 1.06124.02.0 • ON REQUEST: Zinc plated steel striker item 1.06232.01.0 	 1 00100 00 1	4	67	25	70	1,000	12	1 57313 73 0				
									As above, keyed alike (KA)				
	<ul style="list-style-type: none"> • 1 key 	 1 00100 00 1	4	67	25	70	1,016	12	1 57313 72 0				
	<ul style="list-style-type: none"> • Case height 82 mm. • 2 keys • deadbolt and latch • Inside steel rose item 1.06124.02.0 • Pre-set for additional locking points • Pair of threaded bushings (M8) item 1.06290.10.0 • ON REQUEST: Extension bolts item 1.06415.00.0 Extension bolts item 1.07088.03.0 Floor striker item 1.06086.00.0 Floor striker with dust cover item 1.06086.02.0 Zinc plated steel striker item 1.06232.01.0 	 1 00100 00 1	4	67	25	70	1,100	12	1 57318 73 0				
									As above, keyed alike (KA)				
	<ul style="list-style-type: none"> • 1 key 	 1 00100 00 1	4	67	25	70	1,100	12	1 57318 72 0				
	<ul style="list-style-type: none"> • Case height 82 mm. • 2 keys • deadbolt only • Inside steel rose item 1.06124.02.0 • Pre-set for extension bolts • Pair of threaded bushings (M8) item 1.06290.10.0 • ON REQUEST: Extension bolts item 1.06415.00.0 Extension bolts item 1.07088.03.0 Floor striker item 1.06086.00.0 Floor striker with dust cover item 1.06086.02.0 Zinc plated steel striker item 1.06232.00.0 	 1 00100 00 1	4		25	70	0,990	12	1 57336 70 0				
									As above, keyed alike (KA)				
	<ul style="list-style-type: none"> • 1 key 	 1 00100 00 1	4	67	25	90	1,100	12	1 57353 90 0				
	<ul style="list-style-type: none"> • Case height 78 mm. • 2 keys • deadbolt and latch • Adjustable latch bolt • Inside steel rose item 1.06124.02.0 • ON REQUEST: Zinc plated steel striker item 1.06232.01.0 	 1 00100 00 1	4	67	25	90	1,100	12	1 57353 90 0				
									As above, keyed alike (KA)				
	<ul style="list-style-type: none"> • 1 key 	 1 00100 00 1	4	67	25	90	1,100	12	1 57353 90 0				

Type	Description	Key item	Throws	Centre Distance	Faceplate	Backset	Unit weight 	Pieces 	ITEM			
									Type	Dim.	Hand	Fin.
	<ul style="list-style-type: none"> • Case height 78 mm. • 2 keys • deadbolt and latch • Adjustable latch • Inside steel rose item 1.06124.02.0 • Pre-set for extension bolts • Pair of threaded bushings (M8) item 1.06290.05.0 • Threaded rods for fixing bushings and extension bolts • ON REQUEST: Extension bolts item 1.06441.15.0 Extension bolts item 1.07088.03.0 Floor striker item 1.06086.00.0 Floor striker with dust cover item 1.06086.02.0 Zinc plated steel striker item 1.06232.01.0 	 1 00100 00 1	4	67	25	90	1,225	12	1	57358	90	0
	<ul style="list-style-type: none"> • As above, keyed alike (KA) • 1 key 	 1 00100 00 1	4	67	25	90	1,225	12	1	57358	92	0
	<ul style="list-style-type: none"> • Case height 78 mm. • 2 keys • Deadbolt only • Inside steel rose item 1.06124.02.0 • Pre-set for extension bolts • Pair of threaded bushings (M8) item 1.06290.05.0 • Threaded rods for fixing bushings and extension bolts • ON REQUEST: Extension bolts item 1.06441.15.0 Extension bolts item 1.07088.03.0 Floor striker item 1.06086.00.0 Floor striker with dust cover item 1.06086.02.0 Zinc plated steel striker item 1.06232.00.0 <p>TO BE DISCONTINUED</p>	 1 00100 00 1	4		25	90	1,096	12	1	57378	90	0

Type	Description	For series/item	Unit weight Kg	Pieces	ITEM				
					Type	Dim.	Hand	Fin.	Pers.

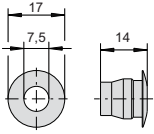

- Black nylon rose

02400

0,001

100

1 06002 00 0

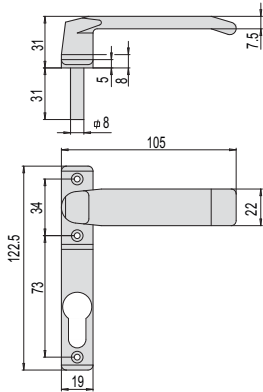

- Black nylon, low handle, charged with 20% glass fibres, specifically for the 46305 series locks
- 3 fastening screws

46305

0,100

12

1 06003 00 0

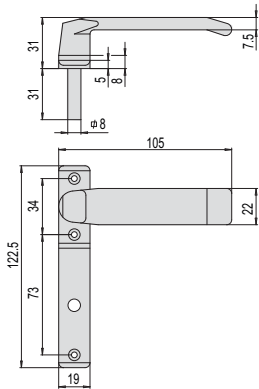

- Handle, in 20 % fiber glass reinforced black nylon, for use with locks series 46307
- 3 fixing screws

46307

0,100

12

1 06003 01 0

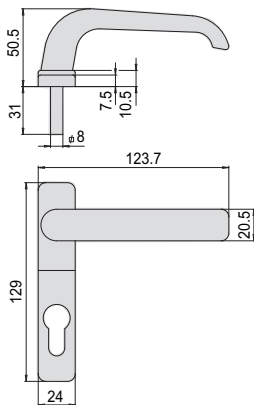

- Black nylon, low handle, charged with 20% glass fibres, specifically for the 46305 series locks
- 3 fastening screws

46305

0,112

12

1 06004 00 0

Type	Description	For series/item	Unit weight Pieces	ITEM		
				Type	Dim. Hand	Fin. Pers. Spec.
	<ul style="list-style-type: none"> • Handle and edge cover in 20% fiber glass reinforced black nylon, for use with locks series 46307 • 3 fixing screws 	46307	0,120 12	1	06004 01 0	
	<ul style="list-style-type: none"> • Lock shutter accessory 		0,100 12	1	06005 00 0	
	<ul style="list-style-type: none"> • Zinc plated steel rose 	42012, 42022, 42032, 42112, 42122, 42212, 42312, 42412, 42422, 42512, 56013, 56016, 56358, 56378	0,020 100	1	06075 00 0	
	<ul style="list-style-type: none"> • Brass floor striker diameter 11 mm. • FOR: extension bolts with rods diameter 10 mm. 	1 06415 00 0, 1 06441 15 0, 1 07088 03 0, 1 07088 04 0, 43090, 43190, 43690, 46445, 52526, 53131, 53137, 53151, 53157, 56255, 57015, 57019, 57020, 57024, 57033, 57055, 57215, 57217, 57255, 57259, 57265, 57296, 57831, 57837, 57851, 57857	0,016 12	1	06086 00 0	

Type	Description	For series/item	Unit weight Pieces	ITEM				
				Type	Dim.	Hand	Fin.	Pers.
	<ul style="list-style-type: none"> • Brass floor striker with spring dust-cover, diameter 12 mm. • USED FOR: Internal extension bolts with 8 mm. diameter rods multi-point locks series 46445 Extension bolt for Multitop item 1.06449.11.0 	1 06415 00 0, 1 06441 00 0, 1 06441 10 0, 1 06441 15 0, 1 06441 20 0, 1 06451 00 0, 1 06451 10 0, 1 07088 00 0, 1 07088 03 0, 1 07088 04 0, 43090, 43190, 43690, 46445, 52526, 53131, 53137, 53151, 53157, 56255, 57015, 57020, 57033, 57215, 57217, 57255, 57265, 57296, 57831, 57851	0,020	12	1	06086	02	0
	<ul style="list-style-type: none"> • Zinc plated steel rose 	16325, 42012, 42022, 42032, 42112, 42122, 42212, 42412, 42422, 42512, 46800, 46803, 46815, 46820, 46823, 46825, 46860, 46865, 46870, 46873, 46875, 46878	0,014	100	1	06092	00	0
	<ul style="list-style-type: none"> • Zinc plated steel rose 	17353, 17358, 57013, 57016, 57030, 57035, 57223, 57226, 57313, 57318, 57333, 57336, 57353, 57358, 57378	0,043	12	1	06124	00	0
	<ul style="list-style-type: none"> • Zinc plated steel rose 	17353, 17358, 57013, 57016, 57030, 57035, 57223, 57226, 57313, 57318, 57333, 57336, 57353, 57358, 57378	0,020	12	1	06124	02	0
	<ul style="list-style-type: none"> • Nylon rose, to be use for interchangeability with lock series 57300 		0,004	12	1	06141	56	0

Type	Description	For series/item	Unit weight Kg	Pieces	ITEM				
					Type	Dim.	Hand	Fin.	Pers. Spec.
	<ul style="list-style-type: none"> Noise proof bushes for bolts diameter 8.5 mm. (2 pieces) diameter 10 mm. (1 piece) 	1 06441 00 0, 1 06441 10 0, 1 06441 20 0, 1 06451 00 0, 1 06451 10 0, 1 07088 00 0	0,004	25	1	06147	00	0	
	<ul style="list-style-type: none"> Zinc plated steel striker 	17353, 17358, 56013, 56016, 56358, 56378, 57013, 57016, 57030, 57035, 57223, 57226, 57333, 57336	0,055	25	1	06232	00	0	
	<ul style="list-style-type: none"> Zinc plated steel striker 	56358, 57313, 57318, 57353, 57358, 57378	0,056	25	1	06232	01	0	
	<ul style="list-style-type: none"> Zinc-plated steel faceplate 	46215, 46217, 46225, 46227, 46815, 46825, 46827	0,086	25	1	06232	20	0	
	<ul style="list-style-type: none"> Zinc plated steel striker 	46305, 46307, 46800, 46802, 46803, 46820, 46822, 46823, 46860, 46865	0,056	25	1	06232	21	0	
	<ul style="list-style-type: none"> Adjustable zinc-plated steel striker 2 fastening screws 	46305, 46307	0,038	25	1	06232	22	0	
	<ul style="list-style-type: none"> Set of threaded bushes (M8) in metal 	1 06441 20 0, 16325, 17358, 56358, 56378, 57358, 57378	0,050	12	1	06290	05	0	
	<ul style="list-style-type: none"> Set of threaded bushes (M8) in metal 	19225, 49225, 49228, 49250	0,050	12	1	06290	06	0	

Type	Description	For series/item	Unit weight Pieces	ITEM				
				Type	Dim.	Hand	Fin.	Pers. Spec.
	<ul style="list-style-type: none"> • Pair of threaded steel bushings (M8), anti-unscrewing 	46800, 46301 56016, 57016, 57035, 57226, 57318, 57336	0,025	12	1	06290	10	0
	<ul style="list-style-type: none"> • Zinc plated steel saw resistant tip, 10 mm. • Side push resistance KN 15 	1 06415 00 0, 1 06416 00 0, 1 06441 15 0, 1 07088 04 0	0,056	12	1	06291	00	0
	<ul style="list-style-type: none"> • Zinc plated hardened steel tip, dia. 10 mm. • Side push resistance KN 25 	1 06415 00 0, 1 06416 00 0, 1 06441 15 0, 1 07088 03 0 1 07088 04 0	0,054	12	1	06291	05	0
	<ul style="list-style-type: none"> • Zinc plated steel pin connector 	1 06415 00 0, 1 06416 00 0, 1 06441 00 0, 1 06441 10 0, 1 06441 15 0, 1 06441 20 0, 1 06451 00 0, 1 06451 10 0, 1 07088 00 0, 1 07088 03 0 1 07088 04 0	0,016	12	1	06291	20	0
	<ul style="list-style-type: none"> • Zinc plated hardened steel tip, dia. 14 mm 	1 07088 05 0	0,100	12	1	06291	07	0
	<ul style="list-style-type: none"> • Zinc plated extension bolts • SUPPLIED AS STANDARD: Pair of bolts dia. 8 mm. Pair of tips dia. 10 mm. item 1.06291.05.0 (2 pieces) 	52526, 56016, 56255, 57015, 57016, 57019, 57033, 57035, 57215, 57217, 57225, 57226, 57255, 57256, 57265, 57296, 57318, 57336	0,533	12	1	06415	00	0
	<ul style="list-style-type: none"> • Zinc plated extension bolts • SUPPLIED AS STANDARD: Pair of bolts diameter 8 mm. Hardened steel tip diameter 10 mm. item 1.06291.05.0 (Pcs. 2) 	16325, 17358, 56358, 56378, 57358, 57378	0,530	12	1	06441	15	0

Type	Description	For series/item	Unit weight Pieces	ITEM				
				Type	Dim.	Hand	Fin.	Pers. Spec.
	<ul style="list-style-type: none"> Internal rose AVAILABLE FINISHES: Polished brass (fin. 00) Polished chrome (fin. 18) Shotgun grey (fin. 46) Anodised light bronze (fin. 65) Anodised dark bronze (fin. 64) 	06460, 06461, 06480, 06485	0,116	12	1	06473	00	0
	<ul style="list-style-type: none"> Nylon contact set complete with spacers: 2 mm. (Pcs. 4) 	11000, 12000, 13000	0,035	6	1	06510	00	0
	<ul style="list-style-type: none"> Roller striker painted aluminium grey 	11721, 11731, 11921, 11931	0,183 0,182	6 6	1	07018	00	1 N7 2 N7
	<ul style="list-style-type: none"> Zinc plated striker 	11921, 11931	0,172 0,183	6 6	1	07018	00	3 4
	<ul style="list-style-type: none"> Striker set including: slide anchoring plate screws 	11610, 11630, 11921, 11931	0,100 0,100	1 1	1	07018	10	3 4
	<ul style="list-style-type: none"> Zinc plated roller striker 	11761, 11771	0,198 0,198	6 6	1	07020	00	1 2
	<ul style="list-style-type: none"> Striker 	1A721, 1A731	0,200	6	1	07021	00	0

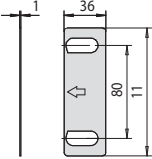
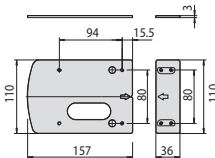
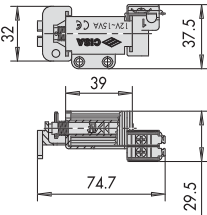
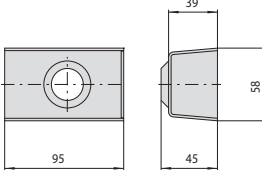
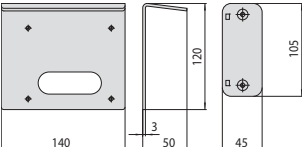
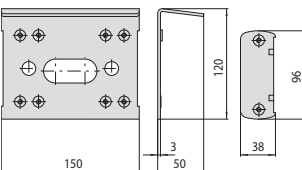
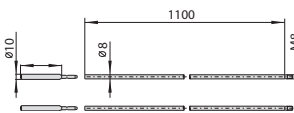
Type	Description	For series/item	Unit weight Kg	Pieces	ITEM				
					Type	Dim.	Hand	Fin.	Pers.
	• 1 mm spacer for striker	1A721, 1A731	0,025	6	1	07021	01	0	
	• Backplate for lock and striker to be welded	1A721, 1A731	0,435	6	1	07021	05	0	
	• Coil set • 12V ac CE	1A610, 1A611, 1A630, 1A631, 1A721, 1A731	0,092	6	1	07025	00	0	
	• Zinc plated steel protective box for outside cylinder		0,200	10	1	07056	00	0	
	• Protective back plate, striker spacer and zinc plated steel screws	11721, 11726, 11731, 11736, 11761, 11771, 11921, 11931	0,645	12	1	07061	00	1	
	• Protective back plate, striker spacer and zinc plated steel screws	50411, 50421, 50471, 50481, 50511, 50521, 50571, 50581	0,635	12	1	07061	10	0	
	• Zinc plated extension bolts • SUPPLIED AS STANDARD: Pair of bolts diameter 8 mm. Hardened steel tip diameter 10 mm. item 1.06291.05.0 (Pcs. 2)	16325, 17358, 46305, 46307, 46800, 46802, 46820, 46822, 46825, 46827, 46865, 46875, 46860, 46870, 56016, 56378, 57016, 57035, 57226, 57318, 57336, 57358, 57378	0,567	12	1	07088	03	0	

Type	Description	For series/item	Unit weight Pieces	ITEM		
				Type	Dim. Hand	Fin. Pers. Spec.
	<ul style="list-style-type: none"> Zinc-plated internal bolt extension rods with screw SUPPLIED AS STANDARD: - Rod diameter 8 mm. 	16325, 17358, 46305, 46307, 46800, 46802, 46820, 46822, 46825, 46827, 46865, 46875, 46860, 46870, 56016, 56378, 57016, 57035, 57226, 57318, 57336, 57358, 57378	0,263	50	1	07088 03 0 DZ
	<ul style="list-style-type: none"> Quick-lock internal extension bolts SUPPLIED AS STANDARD: pair of 8 mm diameter bolts Hardened steel tip diameter 10 mm. item 1.06291.05.0 (Pcs. 2) 		0,575	12	1	07088 04 0
	<ul style="list-style-type: none"> Quick-lock internal extension bolts SUPPLIED AS STANDARD: pair of 8 mm diameter bolts ON REQUEST: tip set (2 pcs) 	46303, 46323, 56358	0,430	12	1	07088 04 0 00 CG
	<ul style="list-style-type: none"> Zinc plated extension bolts SUPPLIED AS STANDARD: Pair of bolts diameter 8 mm. Hardened steel tip diameter 14 mm. item 1.06291.07.0 (Pcs. 2) 	16325, 17358, 46300, 46302, 46305, 46307, 46320, 46322, 46325, 46327, 46365, 46375, 56016, 56358, 57016, 57035, 57226, 57318, 57336, 57358, 57378	0,575	12	1	07088 05 0
	<ul style="list-style-type: none"> Coil set 12 V ac Black nylon support 	11610, 11611, 11630, 11631, 11670, 11671, 11721, 11731, 11761, 11771, 11823, 11921, 11931	0,087	6	1	07118 00 1
	<ul style="list-style-type: none"> Coil set 24 V ac Black nylon support 	11610, 11611, 11630, 11631, 11670, 11671, 11721, 11731, 11761, 11771, 11823, 11921, 11931	0,075	6	1	07118 01 1
			0,082	6	1	07118 01 2

Type	Description	For series/item	Unit weight Pieces	ITEM				
				Type	Dim.	Hand	Fin.	Pers. Spec.
	<ul style="list-style-type: none"> • Adjustable coil set • 12 V ac • Blue nylon support 	11610,11611,	0,075	6	1	07120	00	1
		11630,11631, 11670,11671, 11721,11731, 11761,11771, 11823,11921, 11931	0,074	6	1	07120	00	2
	<ul style="list-style-type: none"> • Adjustable coil set • 24 V ac • Blue nylon support 	11610,11611,	0,075	6	1	07120	01	1
		11630,11631, 11670,11671, 11721,11731, 11761,11771, 11823,11921, 11931	0,075	6	1	07120	01	2
	<ul style="list-style-type: none"> • Set of coils • 12 V ac 	17352,17353, 17357,17358	0,035	6	1	07128	00	0

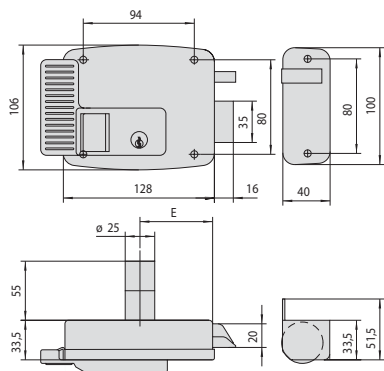

11721, 11731, 11921, 11931

E = 50 - 60 - 70 - 80

1

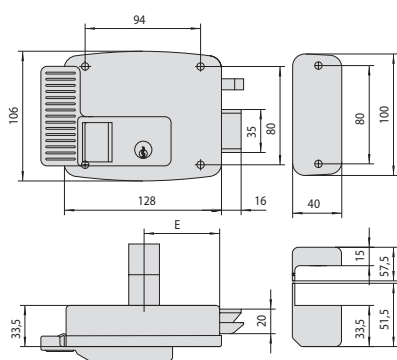

11921, 11926, 11931, 11936

E = 50 - 60 - 70 - 80

4

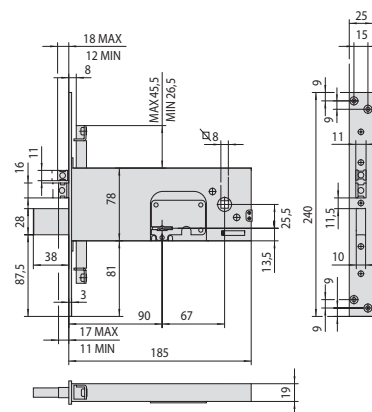

1.17358.90

7

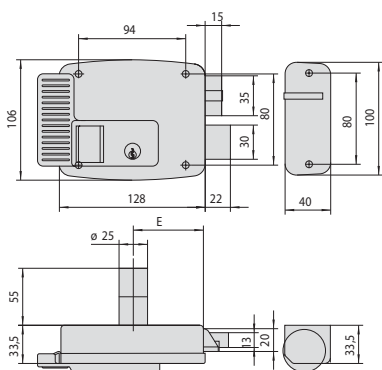

11761, 11771

E = 50 - 60 - 70 - 80

2

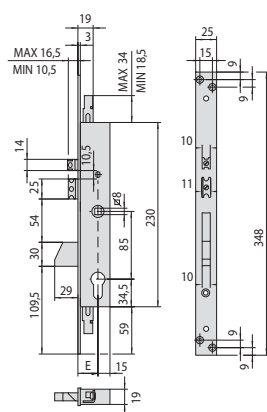

16325
E = 25 - 30 - 35

5

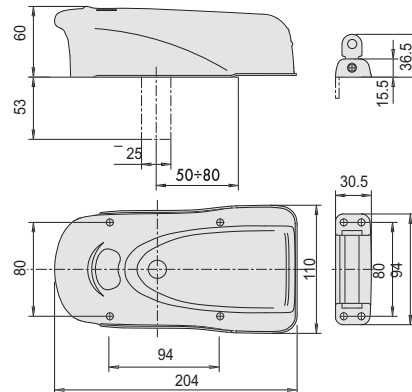

1A610, 1A611, 1A630, 1A631, 1A721, 1A731

8

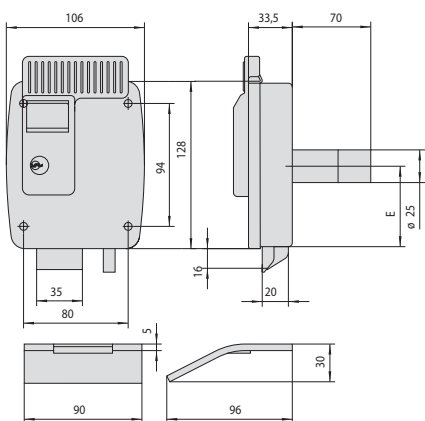

1.11823.80

3

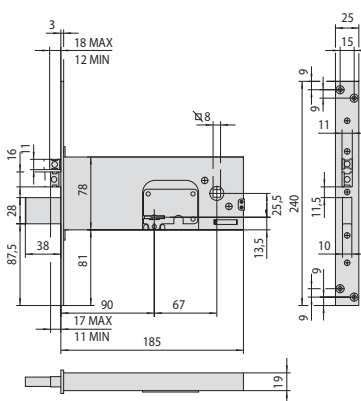

1.17353.90

6

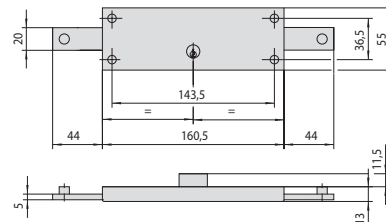

1.41010.80

9

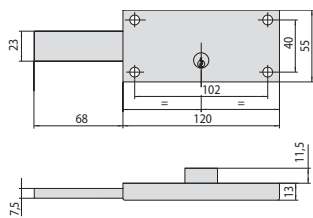

1.41110.60, 1.41111.60

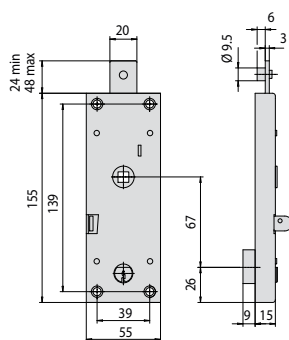

1.41600.00.0

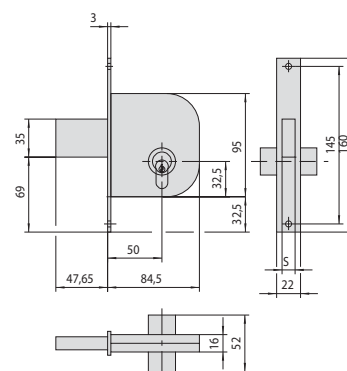

1.42010.50, 1.42012.50 5
1.42020.50, 1.42022.50 12
9

10

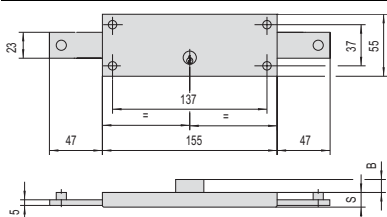

	S	B
1.41210.78	20	6,5
1.41320.78	17	9,5
1.41410.78	15	6
1.41510.78	15	5,5

13

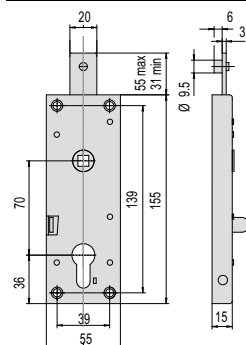

1.41620.00.0

16

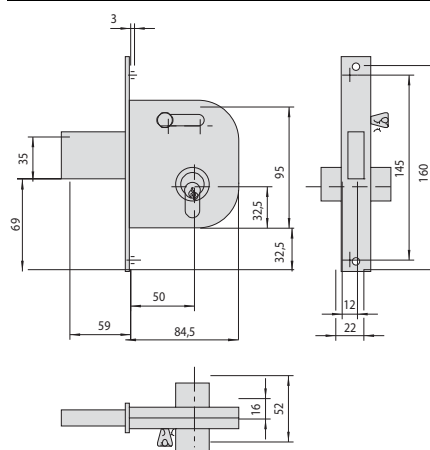

1.42030.50, 1.42032.50

11

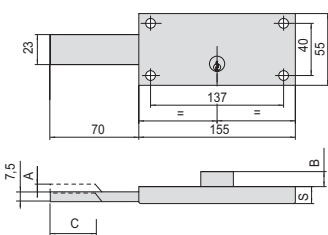

	S	B	A	C
1.41220.78	20	6,5		
1.41221.78	20	6,5		
1.41230.78	20	6,5		
1.41231.78	20	6,5		
1.41310.78	17	9,5		
1.41311.78	17	9,5		
1.41420.78	15	6		
1.41421.78	15	8,5		
1.41525.78	15	5,5	5	31
1.41526.78	15	5,5	5	31

14

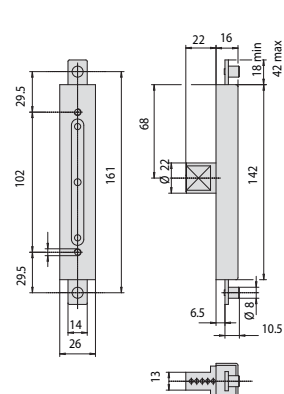

1.41650.00.0

17

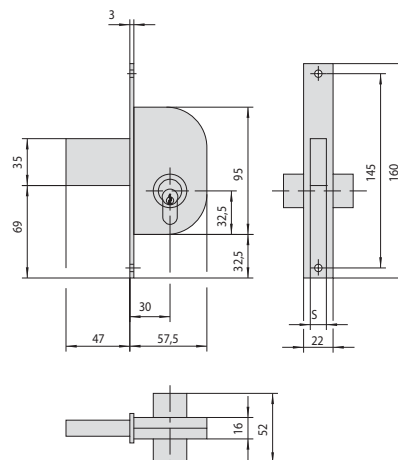

1.42110.30, 1.42112.30 5
1.42120.30, 1.42122.30 12
9

12

15

18

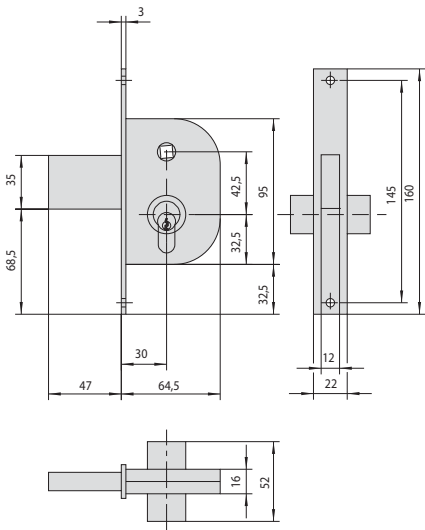

1.42210.30, 1.42212.30

19

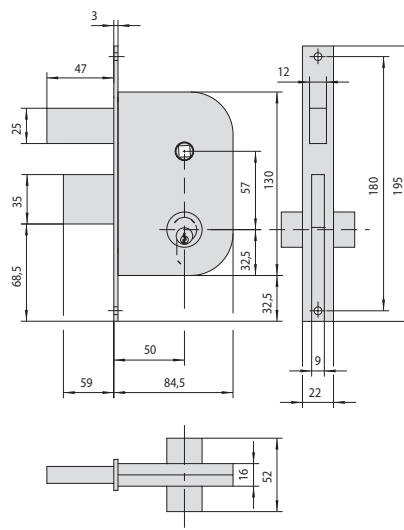

1.42510.50, 1.42512.50

22

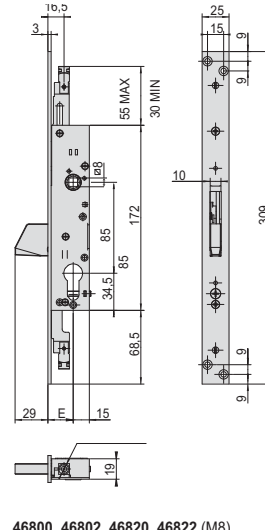

46800, 46802, 46820, 46822 (M8)
46803, 46823 (aggancio rapido)
E = 25 - 30 - 35

25

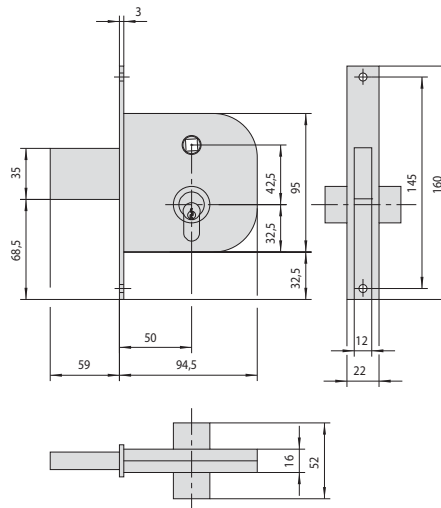

1.42310.50, 1.42312.50

20

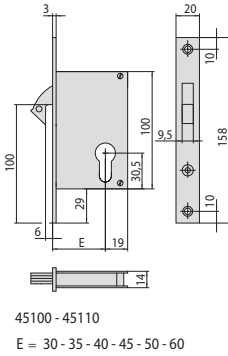

45100 - 45110
E = 30 - 35 - 40 - 45 - 50 - 60

23

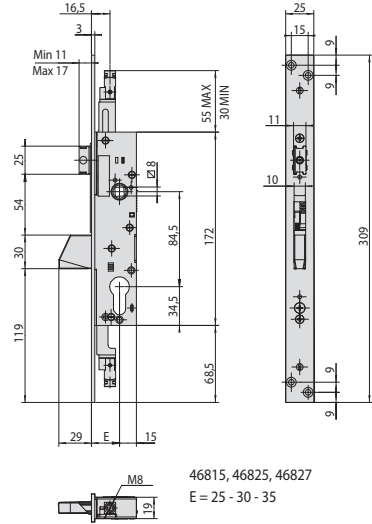

46815, 46825, 46827
E = 25 - 30 - 35

26

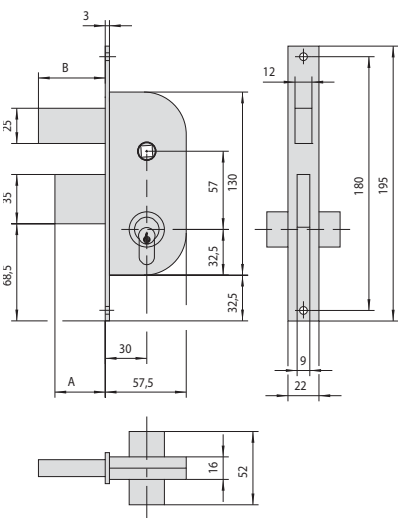

	A	B
1.42410.30, 1.42412.30	47	47
1.42420.30, 1.42422.30	28	24

21

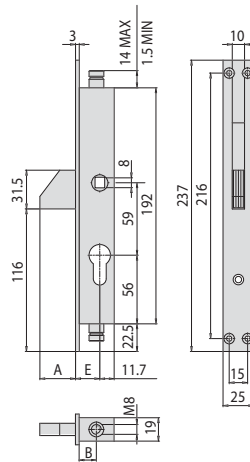

	E	A	B
1.46305.19.0	19,7	29	14
1.46305.25.0	25,7	23	20
1.46305.30.0	31,7	22	26,5
1.46307.19.0	19,7	29	14
1.46307.25.0	25,7	23	20

24

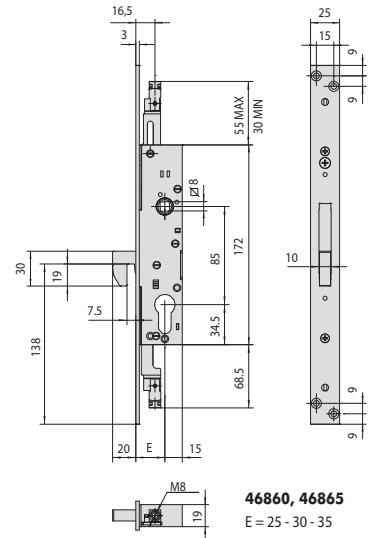

46860, 46865
E = 25 - 30 - 35

27

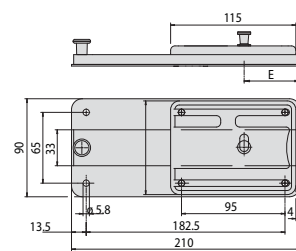
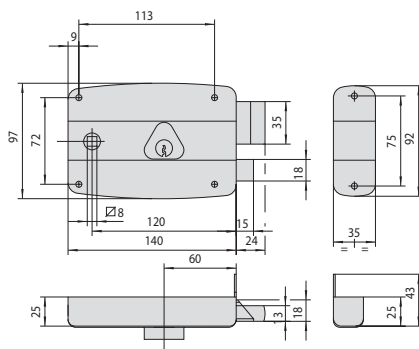
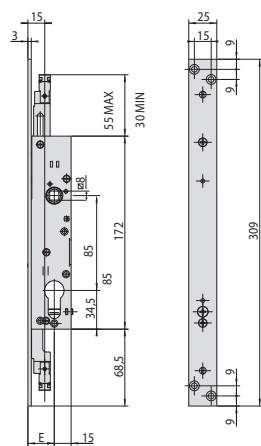

55254, 55274

1.50171.60, 1.50471.60, 1.50481.60

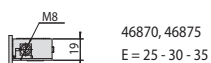

46870, 46875
E = 25 - 30 - 35

28

31

34

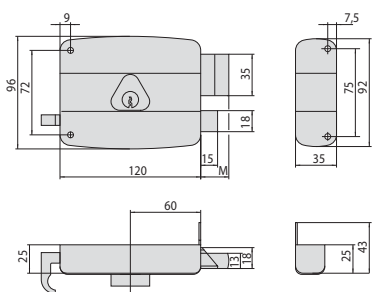

1.50421.60

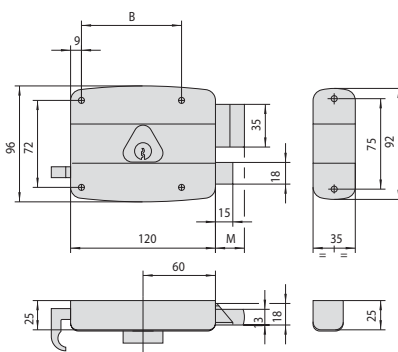

1.50521.60

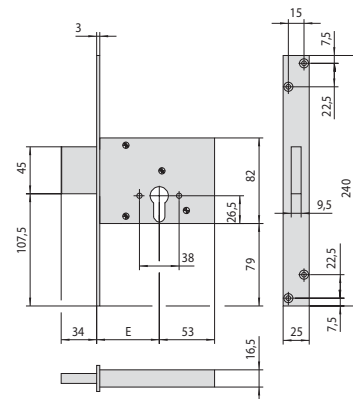

56013
E = 52 - 60 - 70

29

32

35

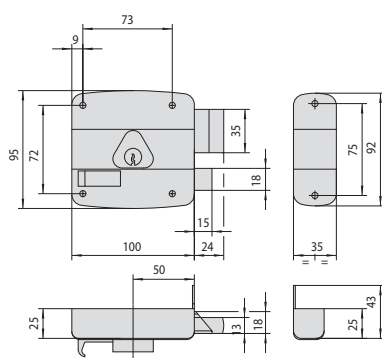

1.50461.50

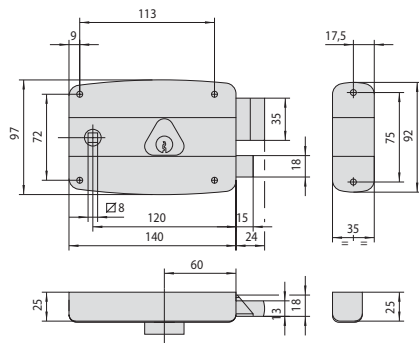

1.50571.60

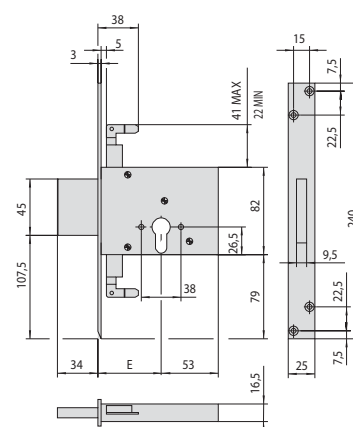

56016
E = 60 - 70

30

33

36

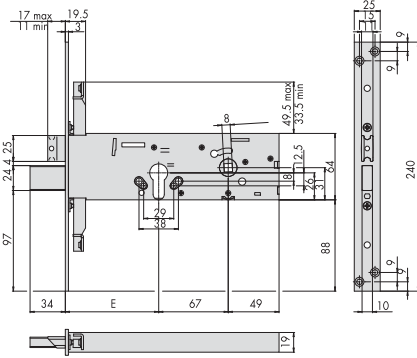

56358

E = 90

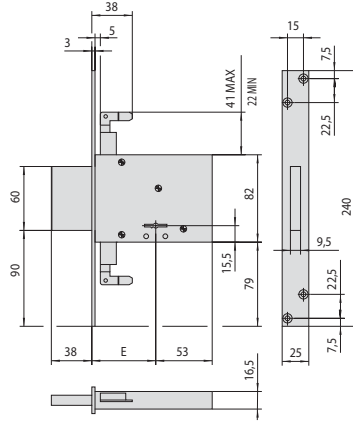

57016
E = 60 - 70

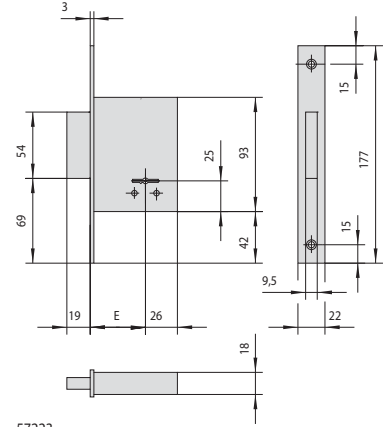

57223
E = 40 - 45 - 50 - 60

37

40

43

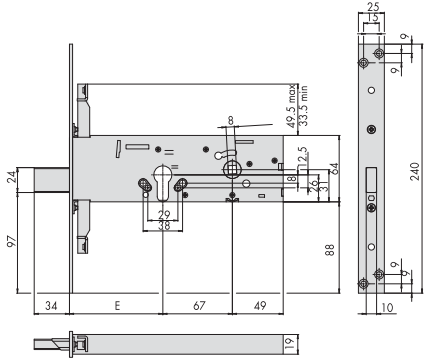

56378

E = 90

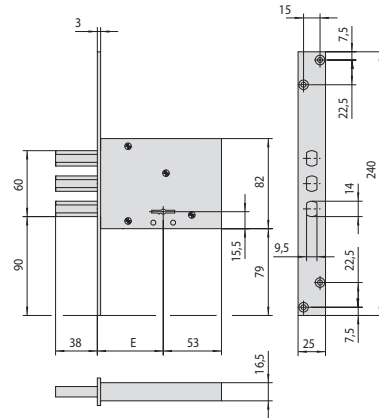

57030
E = 60 - 70

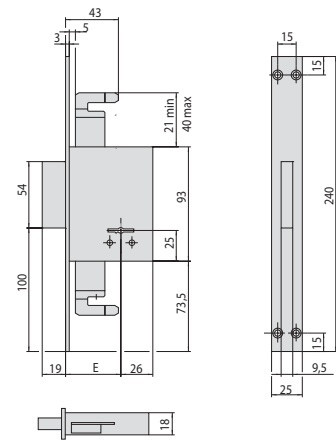

57226
E = 45 - 50 - 60

38

41

44

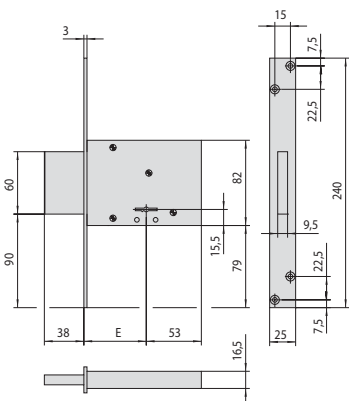

57013
E = 52 - 60 - 70

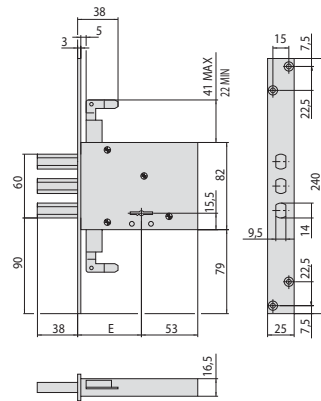

57035
E = 60 - 70

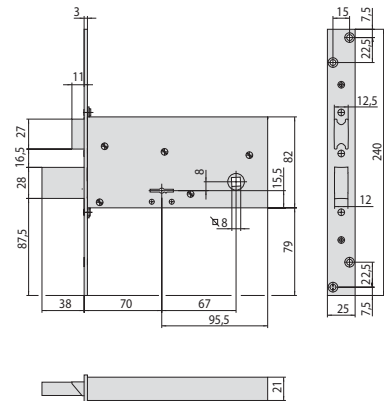

57313

39

42

45

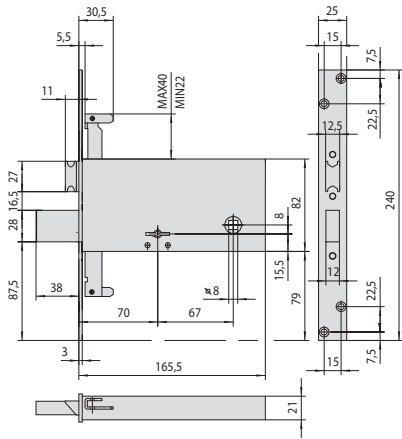

57318

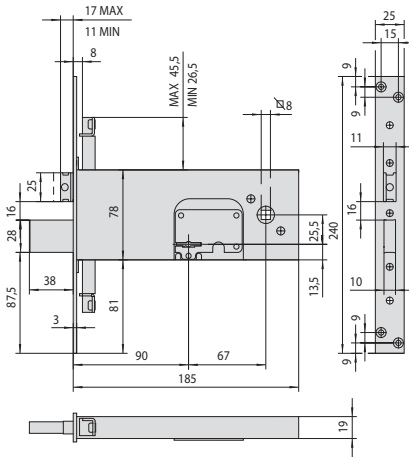

57358, 57378

46

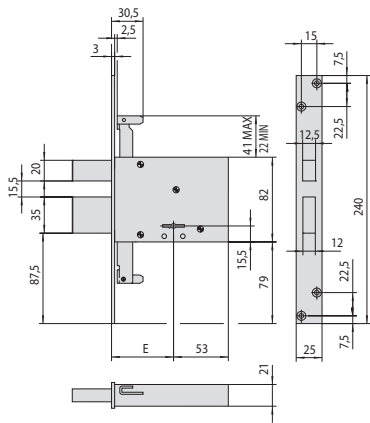

1.57336.70

49

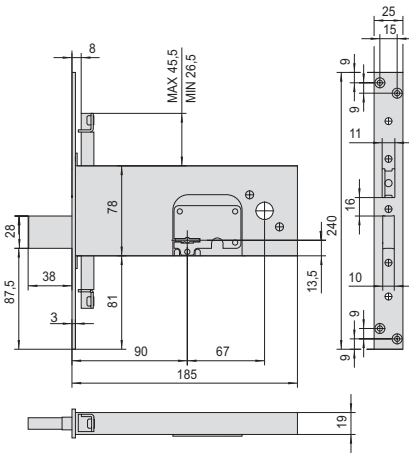

57378

47

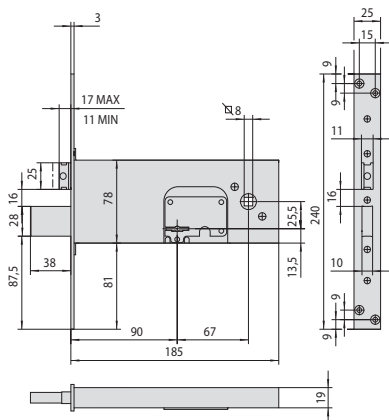

1.57353.90

50



48



Locks for
aluminium doors



Multitop Matic multipoint locks with automatic latches and deadbolts.....	195	Multipoint gear mortice lock, with cylinder	225
Multitop Matic locks with automatic latch and deadbolt ..	198	Cylinder multipoint gear mortice locks 3 SCROCCHI	228
Motorised locks with automatic latch	199	Cylinder multipoint mortice locks with swing bolt	231
MULTITOP MATIC GEXIT	201	Cylinder mortice locks for shutters.....	236
Multitop Matic exit - multipoint antipanic locks with automatic deadbolts.....	204	Cylinder mortice locks with swing bolt	237
Multitop Matic exit - antipanic locks with automatic deadbolt	206	Cylinder mortice locks, mid-rail type H=64 mm.....	243
Multitop Matic exit - multipoint antipanic locks with automatic deadbolts.....	207	Double-bit key mortice locks, mid-rail type E = 70 mm ..	244
Multipoint safety lock for secondary leaf.....	208	Double-bit key mortice locks, mid-rail type E = 90-100 mm ..	246
Safety lock for secondary leaf.....	210	Kits for additional locking points	249
Cisa Motor for Multitop Matic-exit locks	212	Mortice locks with Euro profile cylinder	254
Cylinder gear Mortice locks Multitop Pro RC	213	Oval shaped cylinder mortice locks	256
Cylinder gear mortice locks Multitop Pro	214	Cylinder mortice locks, mid-rail type H = 44-64-77mm ..	260
Cylinder multipoint gear mortice locks Multitop Pro RC ..	215	Cylinder mortice locks, mid-rail type H = 82 mm.....	263
Cylinder gear multipoint electric mortice locks	217	Electric strikers for mortice locks.....	265
Cylinder multipoint gear mortice locks	223	Adjustable metal striker with cam	267
		Adjustable metal striker	271
		Accessories for aluminium locks	274
		Nylon striker	288
		Dimensional drawings	303

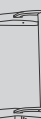



MULTITOP
RC

CISA presents the evolution
of Multitop mechanical locks:

Multitop RC

Secure and **reliable**, as always.
Now, more **compatble** than ever.



Find out more





Technical features:

- Gear-operated system
- 3 adjustable latchbolts
- Adjustable "automatic reset" sensor
- Lateral locking point hooks in hardened steel
- Case in zinc-plated pressure die-cast metal
- Zinc-plated steel cover

Supplied as standard:

- Pair of nylon roses item 1.06012.01.0
- Lock and cylinder fixing screws
- Instructions sheet

On request:

- CISA MOTOR accessory for motorised opening (item 1.E0000.00.0)
- Hold open device (item 1.06120.00.0)

- Euro profile cylinder
- Adjustable metal strikers (see special vademecum)
- Cylinder protective rose item 1.06460.05.0
- Top extension bolt kit 1.06444.86/87/96.0

Standards:

- Grade 6 Security to prEN 15685:2019 (mechanical) and EN14846:08 (mechanical + CISA MOTOR)
- Grade 7 using protective plates item 06436.12/13.0
- Suitable for doors certified to EN 1627:2021 up to resistance class WK/RC4

Certifications:

- ICIM EN1585:19 SRM-00137-00

Hand:
0 = Non-handed

Cylinder to be ordered separately



Multitop MATIC



Type	Description	Locking points	Throws	Centre Distance	Faceplate	Backset	Unit weight	Pieces	ITEM				
									Type	Dim.	Hand	Fin.	Pers. Spec.



- "Flat" adjustable faceplate 24 x 3 mm.
In stainless steel, 2300 mm high.
- top adjustment 350 mm.
- lower adjustment 150 mm.
- 10 to 16 mm adjustable central lock deadlocking latchbolt.
- 9 to 15 mm adjustable lateral locking point 2 latchbolts.
- 9 to 15 mm adjustable "automatic reset" sensor.

ON REQUEST

- CISA MOTOR item 1.E0000.00.0
- Hold open device item 1.06120.00.0
- Top extension bolt kit for doors up to 3000 mm item 1.06444.96.0
- Cylinder protective rose item 1.06460.05.0
- Drill resistant plates for grade 7 prEN 15685:19 item 1.06436.12/13.0

- Certification prEN15685:19
3|S|9|0|G|6|7|0|6|7|0

3	1	85	24	35	3,430	1	1	1	4A000 35 0
3	1	85	24	40	3,490	1	1	1	4A000 40 0
3	1	85	24	45	3,550	1	1	1	4A000 45 0
3	1	92	24	35	3,430	1	1	1	4A010 35 0
3	1	92	24	40	3,490	1	1	1	4A010 40 0
3	1	92	24	45	3,550	1	1	1	4A010 45 0

MATCHING ADJUSTABLE METAL STRIKERS

Central lock item.:	Lateral locking points (2pcs) item
1.06463.05.0	1.06465.05.0
1.06463.16.0	1.06465.06.0
1.06463.67/68.0	1.06465.57/58.0
1.06463.82.0	1.06465.72.0
1.06463.83.0	1.06465.73.0
1.06463.84.0	1.06465.74.0
1.06463.85.0	1.06465.75.0
1.06461.07.0	1.06461.12.0
1.06461.17.0	1.06461.22.0
1.06461.30.0	1.06461.34.0
1.06461.35.0	1.06461.39.0

Type	Description	Locking points	Throws	Centre Distance	Faceplate	Backset	Unit weight 	Pieces 	ITEM						
									Type	Dim.	Hand	Fin.	Pers. Spec.		
	<ul style="list-style-type: none"> U-shaped adjustable faceplate 24 x 5 mm. In stainless steel, 2300 mm high. - top adjustment 350 mm. - bottom adjustment 150 mm. 	3	1	85	24	35	3,430	1	1	4A100	35	0			
		3	1	85	24	40	3,490	1	1	4A100	40	0			
		3	1	85	24	45	3,550	1	1	4A100	45	0			
	<ul style="list-style-type: none"> 10 to 16 mm adjustable central lock deadlocking latchbolt. 	3	1	92	24	35	3,430	1	1	4A110	35	0			
	<ul style="list-style-type: none"> 9 to 15 mm adjustable lateral locking point 2 latchbolts. 	3	1	92	24	40	3,490	1	1	4A110	40	0			
	<ul style="list-style-type: none"> 9 to 15 mm adjustable "automatic reset" sensor. 	3	1	92	24	45	3,550	1	1	4A110	45	0			
	<ul style="list-style-type: none"> ON REQUEST - CISA MOTOR item 1.E0000.00.0 - Hold open device item 1.06120.00.0 - Top extension bolt kit for doors up to 3000 mm item 1.06444.86.0 - Cylinder protective rose item 1.06460.05.0 - Protective plates item 1.06436.12/13.0 														
	<ul style="list-style-type: none"> U-shaped adjustable faceplate 24 x 7 mm. In stainless steel, 2300 mm high. - top adjustment 350 mm. - bottom adjustment 150 mm. 	3	1	85	24	35	3,430	1	1	4A200	35	0			
		3	1	85	24	40	3,490	1	1	4A200	40	0			
		3	1	85	24	45	3,550	1	1	4A200	45	0			
	<ul style="list-style-type: none"> 10 to 16 mm adjustable central lock deadlocking latchbolt. 	3	1	92	24	35	3,430	1	1	4A210	35	0			
	<ul style="list-style-type: none"> 9 to 15 mm adjustable lateral locking point 2 latchbolts. 	3	1	92	24	40	3,490	1	1	4A210	40	0			
	<ul style="list-style-type: none"> 9 to 15 mm adjustable "automatic reset" sensor. 	3	1	92	24	45	3,550	1	1	4A210	45	0			
	<ul style="list-style-type: none"> 2 hooks in hardened steel. 														
	<ul style="list-style-type: none"> ON REQUEST - CISA MOTOR item 1.E0000.00.0 - Hold open device item 1.06120.00.0 - Top extension bolt kit for doors up to 3000 mm item 1.06444.87.0 - Cylinder protective rose item 1.06460.05.0 - Drill resistant plates for grade 7 pr EN 15685:19 item 1.06436.12/13.0 														
<ul style="list-style-type: none"> MATCHING ADJUSTABLE METAL STRIKERS Central lock item.: Lateral locking points (2pcs) item 															
1.06463.05.0	1.06465.05.0														
1.06463.16.0	1.06465.06.0														
1.06463.67/68.0	1.06465.57/58.0														
1.06463.82.0	1.06465.72.0														
1.06463.83.0	1.06465.73.0														
1.06463.84.0	1.06465.74.0														
1.06463.85.0	1.06465.75.0														
1.06461.07.0	1.06461.12.0														
1.06461.17.0	1.06461.22.0														
1.06461.30.0	1.06461.34.0														
1.06461.35.0	1.06461.39.0														

Type	Description	Locking points	Throws	Centre Distance	Faceplate	Backset	Unit weight 	Pieces 	ITEM			
									Type	Dim.	Hand	Fin.
	<ul style="list-style-type: none"> • Hold open device for 4A000 series Multitop MATIC locks, 2 different modes: <ul style="list-style-type: none"> - hold open (withdrawn latchbolts and deadbolts); - semi-automatic function (only with withdrawn deadbolts).. 						0,020	12	1	06120	00	0
	<ul style="list-style-type: none"> • Top extension bolt kit for doors up to 3000 mm. • U-shaped adjustable faceplate 24 x 5 mm in STAINLESS steel, 700 mm high. • For series items: 4A100, 4A110 	1	24				0,900	1	1	06444	86	0
	<ul style="list-style-type: none"> • Top extension bolt kit for doors up to 3000 mm. • U-shaped adjustable faceplate 24 x 7 mm in STAINLESS steel, 700 mm high. • For series items: 4A200, 4A210 	1	24				0,900	1	1	06444	87	0
	<ul style="list-style-type: none"> • Top extension bolt kit for doors up to 3000 mm. • "Flat" adjustable faceplate 24 x 3 mm in STAINLESS steel, 700 mm high. • For series items: 4A000, 4A010 	1	24				0,900	1	1	06444	96	0
	<ul style="list-style-type: none"> • Lock protective plate MULTITOP MATIC, series 4A000, to increase drill resistance (grade 7 prEN 15685: 19). 						0,100	6	1	06436	12	0
	<ul style="list-style-type: none"> • Protective plate for lateral locking points, MULTITOP MATIC, series 4A000, to increase drill resistance (grade 7 prEN 15685: 19). 						0,100	6	1	06436	13	0



Technical features:

- Gear-operated system
- Adjustable central lock deadlocking latchbolt.
- Adjustable "automatic reset" sensor.
- Case in zinc-plated pressure die-cast metal
- Zinc-plated steel cover

Supplied as standard:

- Pair of nylon roses item 1.06012.01.0
- Lock and cylinder fixing screws
- Instructions sheet

On request:

- Euro profile cylinder
- Adjustable metal strikers (see special vademecum)
- Cylinder protective rose item 1.06460.05.0

Standards:

- Grade 6 Security to prEN12209:16
- Suitable for doors certified to EN 1627:2021 up to resistance class WK/RC4

Certifications:

- ICIM EN 12209:16 SRM-00136-00

Hand:
A = Non-handed

Cylinder to be ordered separately



Multitop MATIC



Type	Description	Throws	Centre Distance	Faceplate	Backset	Kg	Pieces	ITEM			
								Type	Dim.	Hand	Fin. Pers. Spec.

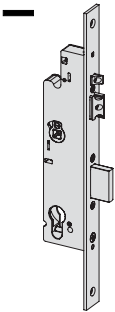

- "Flat" adjustable faceplate 24 x 3 mm. in stainless steel,
- Deadbolt and latchbolt
- 10 to 16 mm adjustable central lock deadlocking latchbolt.
- 9 to 15 mm adjustable "automatic reset" sensor.

ON REQUEST

- Cylinder protective rose item 1.06460.05.0

- Certification EN12209:16
3|X|9|0|0|G|6|7|0

MATCHING ADJUSTABLE METAL STRIKERS

- 1.06463.05.0
- 1.06463.16.0
- 1.06463.67/68.0
- 1.06463.67/68.0
- 1.06463.82.0
- 1.06463.83.0
- 1.06463.84.0
- 1.06463.85.0
- 1.06461.07.0
- 1.06461.17.0
- 1.06461.30.0
- 1.06461.35.0

1	85	24	35	0,840	1	1	4A300 35 0			
1	85	24	40	0,900	1	1	4A300 40 0			
1	85	24	45	0,960	1	1	4A300 45 0			
1	92	24	35	0,840	1	1	4A310 35 0			
1	92	24	40	0,900	1	1	4A310 40 0			
1	92	24	45	0,960	1	1	4A310 45 0			



Technical features:

- Automatic deadbolts and latch
- Lock and motor case thickness 15.5 mm
- Closed case in zinc-plated pressure die-cast metal
- Zinc-plated steel cover
- 10 to 16 mm adjustable deadlocking latchbolt
- 9 to 15 mm adjustable "automatic reset" sensor
- CE 12V DC voltage
- Absorbed current 2A
- Sound signal to indicate open or closed status (deadbolt status)
- Sound signal to indicate any installation errors

Supplied as standard:

- Pair of nylon roses item 1.06012.01.0
- Lock and cylinder fixing screws
- Instructions sheet

On request:

- Euro profile cylinder
- Adjustable metal strikers (see special vademecum)
- Cylinder protective rose item 1.06460.05.0

Certification:

- Grade 6 Security to EN 14846:08
- ICIM EN 14486:08 EST-000019-00:16 SRM-00136-00

Hand:

A = Non-handed

Cylinder to be ordered separately



Multitop MATIC

Type	Description	Throws	Centre Distance	Faceplate	Backset	Unit weight Kg	Pieces	ITEM			
								Type	Dim.	Hand	Fin.

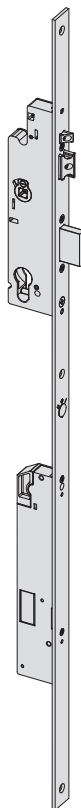

- Centre distance 85 mm
- Stainless steel faceplate 24 x 3 mm
- Deadbolt and latch bolt
- 10 to 16 mm adjustable deadlocking latchbolt
- 9 to 15 mm adjustable "automatic reset" sensor
- The CISA MOTOR, which comes with the lock, allows remote electric opening
 - CE 12V DC voltage
 - Absorbed current 2A
- SUPPLIED AS STANDARD
 - Pair of nylon roses item 1.06012.01.0
 - Lock and cylinder fixing screws
 - Power supply cable item 1.07030.40.0 (L = 4 m)
 - Instruction sheet
- ON REQUEST
 - Adjustable metal strikers items 1.06463.05/16/67/68/82/83/84/85.0, 1.06461.07/17/30/35
 - Cylinder protective rose item 1.06460.05.0
 - Nylon covers item 1.06141.79/89.0
 - Accessory to activate the semi-automatic function (deadbolts deactivated) item 1.0612000.0
- Certification EN14846:08
3|S|9|0|-|J|6|0|3

1	85	24	35	0,840	1	1	1A300 35 0
1	85	24	40	0,840	1	1	1A300 40 0
1	85	24	45	0,840	1	1	1A300 45 0

Type	Description	Throws	Centre Distance	Faceplate	Backset	Unit weight 	Pieces 	ITEM			
								Type	Dim.	Hand	Fin.

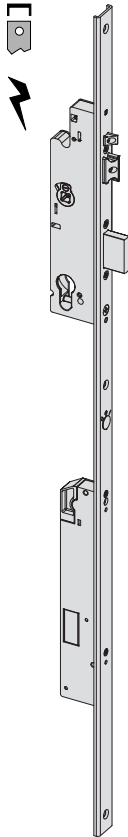

- 'U'-shaped stainless steel faceplate 24 x 5 mm
- Deadbolt and latchbolt
- 10 to 16 mm adjustable deadlocking latchbolt
- 9 to 15 mm adjustable "automatic reset" sensor
- The CISA MOTOR, which comes with the lock, allows remote electric opening
 - CE 12V DC voltage
 - Absorbed current 2A
- SUPPLIED AS STANDARD
 - Pair of nylon roses item 1.06012.01.0
 - Lock and cylinder fixing screws
 - Power supply cable item 1.07030.40.0 (L = 4 m)
 - Instruction sheet
- ON REQUEST
 - Adjustable metal strikers items 1.06463.05/16/67/68/82/83/84/85.0, 1.06461.07/17/30/35
 - Cylinder protective rose item 1.06460.05.0
 - Nylon covers item 1.06141.79/89.0
 - Accessory to activate the semi-automatic function (deadbolts deactivated) item 1.0612000.0

1	85	24	35	0,840	1	1	1A400 35 0				
1	85	24	40	0,840	1	1	1A400 40 0				



MULTITOP MATIC EXIT

Automatic locking system
fo emergency exit doors.

Multitop Matic Exit

Its **strengths** are your **advantages**.

Multitop Matic EXIT safety lock
for double-lead door installation

Multitop Matic EXIT
lock

AUTOMATIC
RESET



EASY TO INSTALL
AND ADJUST



EFFORTLESS
MOVEMENTS



CAN BE RETROFITTED
TO SIKUR EXIT



AUTOMATIC
LOCKING,
ALWAYS SECURE



EXIT IN AN
EMERGENCY
GUARANTEED
AT ALL TIMES



3 LATCHBOLTS
ALWAYS ENGAGED



Discover more



Configuration diagram for single-leaf doors

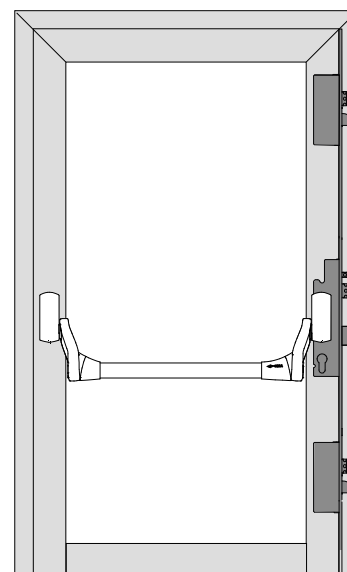
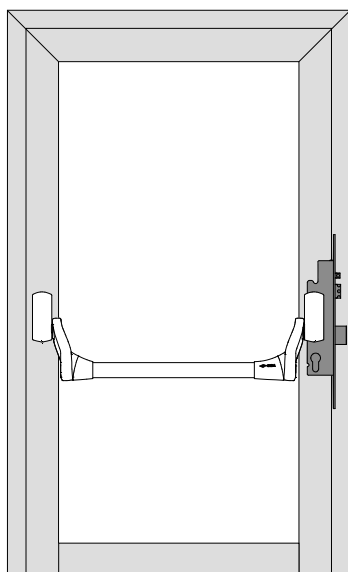

MAIN LOCK "EUROPEAN GROOVE"

ITEM	CODE	FUNCTION
------	------	----------

Lock	14P310xx0 14P330xx0	Function A Function B
Nylon roses (supplied)	-	
Main lock strikers	106463820 106463830	
Fast Touch panic exit device	15971100/010	
Fast Push panic exit device	159607100	
Fast Push bar	107007xx0	
Square spindle	107085770	
Cylinder (optional)	10Q311xx012	
Handle (optional)	107070660B1	Function B
Thumb turn on outside (optional)	107070560B1	Function A

MULTIPOINT LOCK "EUROPEAN GROOVE"

ITEM	CODE	FUNCTION
------	------	----------

Lock	14P010xx0 14P030xx0	Function A Function B
Nylon roses (supplied)	-	
Main lock strikers	106463820 106463830	
Divertor strikers	106465720 106465720	
Fast Touch panic exit device	15971100/010	
Fast Push panic exit device	159607100	
Fast Push bar	107007xx0	
Square spindle	107085-70	
Cylinder (optional)	10Q311XX012	
Handle (optional)	107070660B1	Function B
Thumb turn on outside (optional)	107070560B1	Function A

MAIN LOCK DOOR PROFILE

ITEM	CODE	FUNCTION
------	------	----------

Lock	14P310xx0 14P330xx0	Function A Function B
Nylon roses (supplied)	-	
Main lock strikers	106463840 106463850	
Fast Touch panic exit device	15971100/010	
Fast Push panic exit device	159607100	
Fast Push bar	107007xx0	
Square spindle	107085770	
Cylinder (optional)	10Q311xx012	
Handle (optional)	107070660B1	Function B
Thumb turn on outside (optional)	107070560B1	Function A

MULTIPOINT LOCK DOOR PROFILE

ITEM	CODE	FUNCTION
------	------	----------

Lock	14P110xx0 14P130xx0	Function A Function B
Nylon roses (supplied)	-	
Main lock strikers	106463840 106463850	
Divertor strikers	106465740 106465750	
Fast Touch panic exit device	15971100/010	
Fast Push panic exit device	159607100	
Fast Push bar	107007xx0	
Square spindle	107085-70	
Cylinder (optional)	10Q311XX012	
Handle (optional)	107070660B1	Function B
Thumb turn on outside (optional)	107070560B1	Function A



Configuration diagram dor double leaf doors

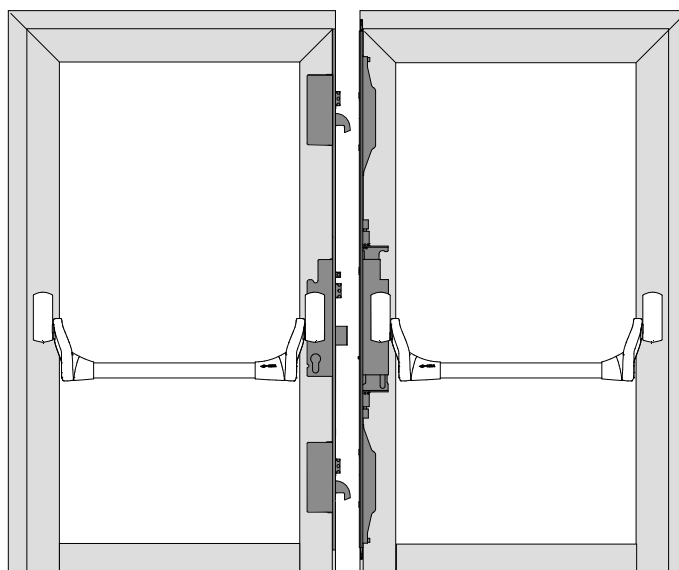
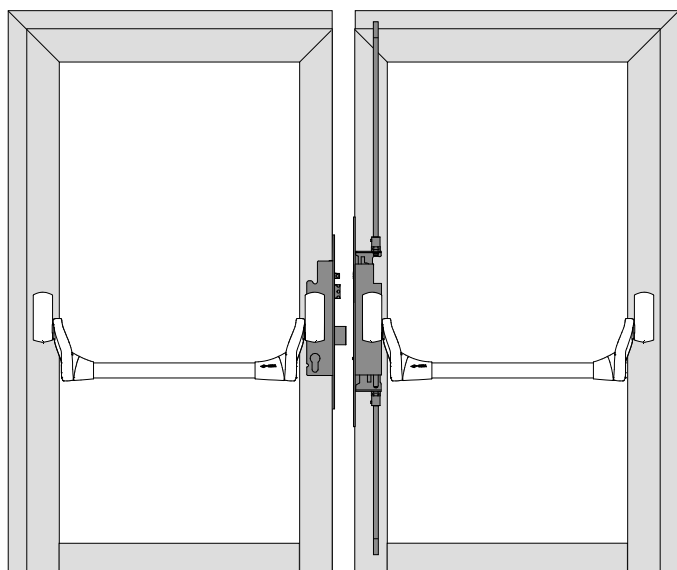

MAIN LOCK "EUROPEAN GROOVE"

ITEM	CODE	FUNCTION
Lock	14P310xx0 14P330xx0	Function A Function B
Secondary lock Nylon roses (supplied)	14D295xx0	
Teflon floor striker (supplied)		
Threaded internal rods with tip Nylon top striker	107088030 106141800	
Automatic reset	10708952/530	
Divertor strikers	106465720 106465720	
Fast Touch panic exit device	15971100/010	
Fast Push panic exit device	159607100	
Fast Push bar	107007xx0	
Square spindle	107085770	
Handle (optional)	107070660B1	Function B
Thumb turn on outside (optional)	107070560B1	Function A

MAIN LOCK DOOR PROFILE

ITEM	CODE	FUNCTION
Lock	14P310xx0 14P330xx0	Function A Function B
Secondary lock Nylon roses (supplied)	14D295xx0	
Teflon floor striker (supplied as standard)		
Threaded internal rods with tip Nylon top striker	107088030 106141800	
Automatic reset	10708952/530	
Divertor strikers	106465740 106465750	
Fast Touch panic exit device	15971100/010	
Fast Push panic exit device	159607100	
Fast Push bar	107007XX0	
Square spindle	107085770	
Handle (optional)	107070660B1	Function B
Thumb turn on outside (optional)	107070560B1	Function A

MULTIPOINT LOCK "EUROPEAN GROOVE"

ITEM	CODE	FUNCTION
Lock	14P010xx0 14P030xx0	Function A Function B
Secondary lock Rod tips (supplied)	14D395xx0	
Teflon floor striker (supplied)		
Adjustable top striker Automatic reset	106141000 107089630	
Fast Touch panic exit device	15971100/010	
Fast Push panic exit device	159607100	
Fast Push bar	107007xx0	
Square spindle	107085770	
Handle (optional)	107070660B1	Function B
Thumb turn on outside (optional)	107070560B1	Function A

MULTIPOINT LOCK DOOR PROFILE

ITEM	CODE	FUNCTION
Lock	14P110xx0 14P130xx0	Function A Function B
Secondary lock Rod tips (supplied)	14D695xx0	
Teflon floor striker (supplied)		
Adjustable top striker Automatic reset	106141000 107089630	
Fast Touch panic exit device	15971100/010	
Fast Push panic exit device	159607100	
Fast Push bar	107007xx0	
Square spindle	107085770	
Handle (optional)	107070660B1	Function B
Thumb turn on outside (optional)	107070560B1	Function A



Technical features:

- Automatic latches and deadbolts
- 3 adjustable latchbolts
- Adjustable “automatic reset” sensor
- Lateral locking point hooks in hardened steel
- Case in zinc-plated pressure die-cast metal
- Zinc-plated steel cover
- 8 mm square spindle

Supplied as standard:

- Pair of nylon roses item 1.06012.01.0
- Lock and cylinder fixing screws
- Instructions sheet

On request:

- CISA MOTOR accessory for motorised opening (item 1.E0000.00.0)
- Hold open device (item 1.06120.00.0)

- Adjustable metal strikers (see special vademecum)
- Cylinder protective rose item 1.06460.05.0
- Drill resistant plates for item 1.06436.12/13.0 for function A and item 1.06436.10/13.0 for function B

Cylinder to be ordered separately



Standards:

- Grade 6 Security to prEN15685:19 (mechanical) and EN14846:08 (mechanical + CISA MOTOR)
- Grade 7 using protective plates item 06436.12/13.0
- Suitable for doors certified to EN1627:11 up to resistance class WK/RC4
- ICIM certified for use on fire/smoke doors according to EN 1634-1 standard

Multitop MATIC EXIT

Type	Description	Function:	Locking points	Throws	Centre Distance	Faceplate	Backset	Unit weight Kg	Pieces	ITEM				
										Type	Dim.	Hand	Fin.	Pers. Spec.



- Centre distance 92 mm
- ‘U’-shaped adjustable faceplate 24 x 5 mm
- In stainless steel, height 2300 mm
 - top adjustment 350 mm
 - bottom adjustment 150 mm
- 10 to 16 mm adjustable central lock deadlocking latchbolt
- 9 to 15 mm adjustable lateral locking point 2 latchbolts
- 9 to 15 mm adjustable “automatic reset” sensor

A	3	1	92	24	35	3,430	1	1	4P110 35 0
A	3	1	92	24	40	3,490	1	1	4P110 40 0
A	3	1	92	24	45	3,550	1	1	4P110 45 0
B	3	1	92	24	35	3,430	1	1	4P130 35 0
B	3	1	92	24	40	3,490	1	1	4P130 40 0
B	3	1	92	24	45	3,550	1	1	4P130 45 0

- Centre distance 92 mm
- ‘U’-shaped adjustable faceplate 24 x 7 mm
- In stainless steel, height 2300 mm
 - top adjustment 350 mm
 - bottom adjustment 150 mm
- 10 to 16 mm adjustable central lock deadlocking latchbolt
- 9 to 15 mm adjustable lateral locking point 2 latchbolts
- 9 to 15 mm adjustable “automatic reset” sensor

A	3	1	92	24	35	3,430	1	1	4P210 35 0
A	3	1	92	24	40	3,490	1	1	4P210 40 0
A	3	1	92	24	45	3,550	1	1	4P210 45 0
B	3	1	92	24	35	3,430	1	1	4P230 35 0
B	3	1	92	24	35	3,490	1	1	4P230 40 0
B	3	1	92	24	45	3,550	1	1	4P230 45 0

- Certification prEN15685:19 3|S|9|0|0|G|6|7|0|6|7|0

FUNCTION TYPE A

Inside: panic exit device to open
 Outside: key to activate the latchbolt and deadbolt

FUNCTION TYPE B

Inside: panic exit device to open, key to activate or deactivate the outside handle
 Outside: key to activate or deactivate the outside handle to control the latchbolt

Type	Description	Function	Locking points	Throws	Centre Distance	Faceplate	Backset	Unit weight 	Pieces 	ITEM			
										Type	Dim.	Hand	Fin.

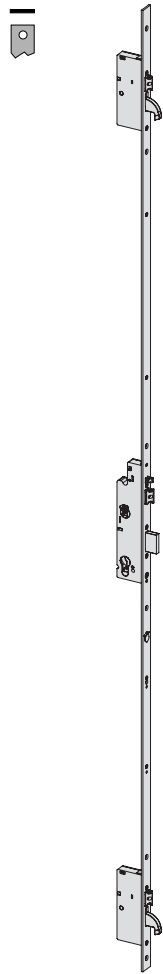

- Centre distance 92 mm
- "Flat" adjustable faceplate 24 x 3 mm
- In stainless steel, height 2300 mm
 - top adjustment 350 mm
 - bottom adjustment 150 mm
- 10 to 16 mm adjustable central lock deadlocking latchbolt
- 9 to 15 mm adjustable lateral locking point 2 latchbolts
- 9 to 15 mm adjustable "automatic reset" sensor
- 2 hooks in hardened steel

A	3	1	92	24	35	3,430	1	1	4P010 35 0				
A	3	1	92	24	40	3,490	1	1	4P010 40 0				
A	3	1	92	24	45	3,550	1	1	4P010 45 0				
B	3	1	92	24	35	3,430	1	1	4P030 35 0				
B	3	1	92	24	40	3,490	1	1	4P030 40 0				
B	3	1	92	24	45	3,550	1	1	4P030 45 0				

FUNCTION TYPE A

Inside: panic exit device to open
 Outside: key to activate the latchbolt and deadbolt

FUNCTION TYPE B

Inside: panic exit device to open, key to activate or deactivate the outside handle
 Outside: key to activate or deactivate the outside handle to control the latchbolt



Technical features:

- Automatic deadbolt
- Adjustable latchbolt
- Adjustable "automatic reset" sensor
- Lateral locking point hooks in hardened steel
- Case in zinc-plated pressure die-cast metal
- Zinc-plated steel cover
- 8 mm square spindle

Supplied as standard:

- Pair of nylon roses item 1.06012.01.0
- Lock and cylinder fixing screws
- Instructions sheet

On request:

- Adjustable metal strikers (see special vademecum)
- Cylinder protective rose item 1.06460.05.0

Standards:

- Grade 6 Security to prEN12209:16 (mechanical)
- Grade 7 using protective plates item 06436.12/13.0
- Suitable for doors certified to EN1627:11 up to resistance class WK/RC4

Cylinder to be ordered separately



Multitop MATIC EXIT

Type	Description	Function:	Locking points	Throws	Centre Distance	Faceplate	Backset	Unit weight 	Pieces 	ITEM				
										Type	Dim.	Hand	Fin.	Pers. Spec.

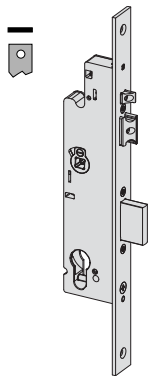

- Centre distance 92 mm
- Stainless steel faceplate 24 x 3 mm
- Deadbolt and latchbolt
- 10 to 16 mm adjustable deadlocking latchbolt
- 9 to 15 mm adjustable "automatic reset" sensor

- Certification EN12209:16
3|X|9|0|0|G|6|7|0

A	1	1	92	24	35	0,840	1	1	4P310 35 0
A	1	1	92	24	40	0,900	1	1	4P310 40 0
A	1	1	92	24	45	0,960	1	1	4P310 45 0
B	1	1	92	24	35	0,840	1	1	4P330 35 0
B	1	1	92	24	40	0,900	1	1	4P330 40 0
B	1	1	92	24	45	0,960	1	1	4P330 45 0

FUNCTION TYPE A

Inside: panic exit device to open
Outside: key to activate the latchbolt and deadbolt

FUNCTION TYPE B

Inside: panic exit device to open, key to activate or deactivate the outside handle
Outside: key to activate or deactivate the outside handle to control the latchbolt



Technical features:

- Automatic deadbolt
- Adjustable latchbolt
- Adjustable "automatic reset" sensor
- Lateral locking point hooks in hardened steel
- Case in zinc-plated pressure die-cast metal
- Zinc-plated steel cover
- CE 12V DC voltage
- Absorbed current 2A
- 8 mm square spindle

Supplied as standard:

- Pair of nylon roses item 1.06012.01.0
- Lock and cylinder fixing screws
- Power supply cable item 1.07030.40.0 (L = 4 m)
- Instructions sheet

On request:

- Adjustable metal strikers (see special vademecum)
- Cylinder protective rose item 1.06460.05.0
- Device for semiautomatic function (item 1.06120.00.0)

Standards:

- Grade 6 Security to prEN14846:08
- Grade 7 using protective plates item 06436.12/13.0
- Suitable for doors certified to EN1627:11 up to resistance class WK/RC4

Cylinder to be ordered separately



Multitop MATIC EXIT

Type	Description	Function:	Locking points	Throws	Centre Distance	Faceplate	Backset	Unit weight	Pieces	ITEM			
										Type	Dim.	Hand	Fin.

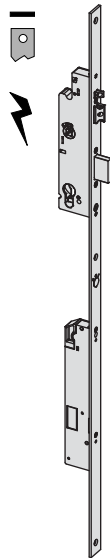

- Centre distance 92 mm
- Stainless steel faceplate 24 x 3 mm
- Deadbolt and latchbolt
- 10 to 16 mm adjustable deadlocking latchbolt
- 9 to 15 mm adjustable "automatic reset" sensor
- The CISA MOTOR, which comes with the lock, allows remote electric opening
- Certification EN14846:08 3|S|9|0|-|J|6|0|3

A	3	1	92	24	35	1,540	1	1	1	IP310 35 0
A	3	1	92	24	40	1,600	1	1	1	IP310 40 0
A	3	1	92	24	45	1,600	1	1	1	IP310 45 0
B	3	1	92	24	35	1,540	1	1	1	IP330 35 0
B	3	1	92	24	40	1,600	1	1	1	IP330 40 0



- Centre distance 92 mm
- 'U'-shaped stainless steel faceplate 24 x 5 mm
- Deadbolt and latchbolt
- 10 to 16 mm adjustable deadlocking latchbolt
- 9 to 15 mm adjustable "automatic reset" sensor
- The CISA MOTOR, which comes with the lock, allows remote electric opening

A	3	1	92	24	35	1,540	1	1	1	IP410 35 0
A	3	1	92	24	40	1,600	1	1	1	IP410 40 0
B	3	1	92	24	35	1,540	1	1	1	IP430 35 0
B	3	1	92	24	40	1,600	1	1	1	IP430 40 0

FUNCTION TYPE A

Inside: panic exit device to open
 Outside: key to activate the latchbolt and deadbolt

FUNCTION TYPE B

Inside: panic exit device to open, key to activate or deactivate the outside handle
 Outside: key to activate or deactivate the outside handle to control the latchbolt



Technical features:

- Closed case in pressure die-cast metal.
- Steel cover.
- 8 mm spindle
- Adjustable latchbolt and deadbolt feeler pin
- Stainless steel top and bottom adjustable faceplate (multipoint locks)
- Adjustable strikers integral to the faceplate

Standards:

- Grade 6 Security of the European standards prEN 15685:19 and EN12209:16
 - Suitable for doors certified to EN1627:11 up to resistance class WK/RC4.
 - System CE-certified in accordance with Regulation (EU) no. 305/2011.
- Regulatory reference documents:
- EN 1125:08 for emergency exits with a panic exit device
 - EN 179:08 for emergency exits with a handle
- Fire resistant in accordance with EN1634.

Multitop MATIC EXIT

Type	Description	Finishes:	Spindle hole	Locking points	Throws	Centre Distance	Faceplate	Backset	Unit weight	Pieces	ITEM				
											Type	Dim.	Hand	Fin.	Pers.

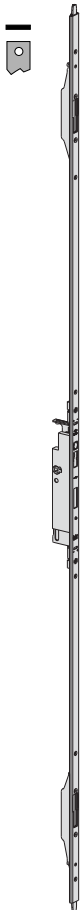

- May be combined with locks series 4P000 and 1P000
- Operation from inside with the panic exit device

• SUPPLIED AS STANDARD

- Floor striker item 1.06142.95.0
- Top/bottom rod tips for door profile item 1.06449.20.0
- Top/bottom rod tips for European groove profile item 1.06449.21.0

• ON REQUEST

- Top slotted striker item 1.06141.00.0
- Long faceplate 24x3x2600
- Automatic dogging device item 1.07089.63.0
- Floor striker item 1.07072.75.0
- Long faceplate 24x3x2600

8	2	92	24	40	3,430	1	1	4D395 40 0
8	2	92	24	60	3,430	1	1	4D395 60 0
8	2	92	24	75	3,430	1	1	4D395 75 0

Type	Description	Finishes:	Spindle hole	Locking points	Throws	Centre Distance	Faceplate	Backset	Unit weight 	Pieces 	ITEM			
											Type	Dim.	Hand	Fin.



- May be combined with locks series 4P000 and 1P000

- Operation from inside with the panic exit device

• **SUPPLIED AS STANDARD**

- Floor striker item 1.06142.95.0
- Top/bottom rod tips for door profile item 1.06449.20.0
- Top/bottom rod tips for "European groove" profile item 1.06449.21.0

• **ON REQUEST**

- Top slotted striker item 1.06141.00.0
- Long faceplate 24x3x2600
- Automatic dogging device item 1.07089.63.0
- Floor striker item 1.07072.75.0
- Long faceplate 24x6x2600

8	2	92	24	40	3,550	1	1	4D695 40 0
8	2	92	24	60	3,550	1	1	4D695 60 0



Technical features:

- Closed case in pressure die-cast metal.
- Steel cover.
- 8 mm spindle
- Adjustable latchbolt and deadbolt feeler pin

Standards:

- Grade 6 Security of the European standard 15685:19 and EN12209:16
- Suitable for doors certified to EN1627:11 up to resistance class WK/RC4.
- System CE-certified in accordance with Regulation (EU) no. 305/2011 Regulatory reference documents:
 - EN1125:08 for emergency exits with a panic exit device
 - EN 179:08 for emergency exits with a handle
- Fire resistant in accordance with EN1634

Multitop MATIC EXIT

Type	Description	Finishes:	Spindle hole	Locking points	Throws	Centre Distance	Faceplate	Backset	Unit weight	Pieces	ITEM			
											Type	Dim.	Hand	Fin.



- Short faceplate 24 x 3
- May be combined with locks series 4P000 and 1P000
- Operation from inside with the panic exit device
- SUPPLIED AS STANDARD
- Nylon spacers item 1.06141.88.
- Floor striker item 1.06142.95.0
- ON REQUEST
- Threaded internal extension bolt rods item 1.07088.03.0
- Top slotted striker item 1.06141.00.0
- Top nylon striker item 1.06141.80.0
- Automatic dogging device item 1.07089.52/53.0

8	2	92	24	40	0,840	1	1	4D295 40 0
8	2	92	24	60	0,840	1	1	4D295 60 0
8	2	92	24	75	0,840	1	1	4D295 75 0

Type	Description	For series/item	Unit weight	Pieces	ITEM				
					Type	Dim.	Hand	Fin.	Pers.
	<ul style="list-style-type: none"> • Top slotted striker in stainless steel 	4D295 4D395 4D695	-	1	1	06141	00	0	
	<ul style="list-style-type: none"> • Teflon-coated slotted floor striker 	4D295 4D395 4D695	-	1	1	06142	95	0	
	<ul style="list-style-type: none"> • Set of top/bottom rod toothed tips for door profile 	4D695	0,057	12	1	06449	20	0	
	<ul style="list-style-type: none"> • Set of top/bottom rod toothed tips for "European groove" profile 	4D395	0,057	12	1	06449	21	0	
	<ul style="list-style-type: none"> • ALIGNED automatic dogging device • For safety locks with internal extension bolt rods • May be combined with extension bolts set item 1.07088.03.0 	4D295	-	1	1	07089	53	0	
	<ul style="list-style-type: none"> • Automatic dogging device • For safety locks with internal extension bolt rods 	4D395 4D695	-	1	1	07089	63	0	



Technical features:

- Case thickness 15.5 mm
- CE 12V DC voltage
- Absorbed current 2A
- Sound signal to indicate open or closed status (deadbolt status)
- Sound signal to indicate any installation error
- If the "handle lock" function is activated, the motor is automatically switched off
- In the event of a power failure, it is still possible to open the door with the keys

Supplied as standard:

- Power supply cable item 1.07030.40.0 (L=4 m)
- 2 fixing screws
- Instructions sheet

On request:

- Signal light to indicate open or closed status (item 1.07126.01/02.0)
- Service cable. (item 07030.40.0)
- Power supply (item 07060.10.0)

Certifications:

- EN 14846:2008
- | 3 | S | 9 | 0 | . | J | 6 | 0 | 3 |

MotoreCISA

Type	Description	For series/item	Kg	Pieces	ITEM					
					Type	Dim.	Hand	Fin.	Pers.	Spec.
	<ul style="list-style-type: none"> • CISA MOTOR for installation on all multipoint Multitop • MATIC locks. • It allows remote electric opening <ul style="list-style-type: none"> - 12V DC voltage - Absorbed current 2A 	4A010, 4A100, 4A110, 4A200, 4A210, 4P010, 4P030, 4P110, 4P130, 4P210, 4P230	0,400	1	1	E0000	00	0		
	<ul style="list-style-type: none"> • Power supply cable (L=4 m). 		0,600	12	1	07030	40	0		
	<ul style="list-style-type: none"> • Power supply cable (L=10 m). 		0,600	12	1	07030	42	0		
	<ul style="list-style-type: none"> • Service cable USB programming cable to set the time in which the motor must remain active for opening 		0,600	1	1	07030	41	0		
	<ul style="list-style-type: none"> • Power supply: <ul style="list-style-type: none"> - Input: 110÷240 Vac - 50/60 Hz - 0.7 A - Output: 12 Vdc - 2.5 A - Output Class 2 - UL Listed Certificated 		0,500	1	1	07060	10	0		
	<ul style="list-style-type: none"> • Red LED 		0,005	6	1	07126	01	0		
	<ul style="list-style-type: none"> • Green LED 		0,005	6	1	07126	02	0		



Technical features:

- Case thickness 15.5 mm
- Gear-operated system
- Off-phase prevention system
- Zinc-plated die-cast alloy case
- Zinc-plated steel case cover
- Latch interchangeable with nickel-plated roller and deadbolt
- Reversible latch
- Pre-set for additional locking points

Supplied as standard:

- Pair of nylon roses item 1.06012.01.0
- Pair of under-faceplate nylon spacers item 1.06141.65.0
- Threaded pins for fixing of extension bolts
- Lock and cylinder fixing screws
- Instruction sheet

On request:

- Special striker plates (see Vademecum)
- "Modular" roller assembly item 1.06000.00.0
- Cylinder protective rose item 1.06460.05.0
- Mechanical control button item 1.06110.15.0
- Threaded bushing for extension bolt item 1.06290.06.0

Certification:

- This lock series is certified according to the European standard EN 12209:16
 - Security class 6 (1000 Kg side thrust and 600 Kg front thrust resistance)
- Suitable for doors certified to EN 1627:2021 up to WK/RC 4 resistance class

Hand:
0 = Non-handed

Cylinder to be ordered separately



Multitop PRO RC

Type	Description	Locking points Throws	Centre Distance	Faceplate	Backset	Unit weight Kg	Pieces	ITEM				
								Type	Dim.	Hand	Fin.	Pers. Spec.



- Stainless steel faceplate 22x3 mm
- Deadbolt and latch
- 11 to 17 mm adjustable latch
- ON REQUEST:
 - Internal ragged extension bolts item 1.06441.00.0
 - Internal straight extension bolts item 1.06441.10.0
 - Pair of external bolt connectors item 1.06442.00.0
 - Extension bolts operated by internal rods item 1.06443.31.0
 - Extension bolts operated by external rods item 1.06443.36.0

2	85	22	25	0,720	12	1	49225	25	0	00	RC
2	85	22	30	0,780	12	1	49225	30	0	00	RC
2	85	22	35	0,840	12	1	49225	35	0	00	RC
2	85	22	40	0,900	12	1	49225	40	0	00	RC
2	92	22	25	0,720	12	1	49228	25	0	00	RC
2	92	22	30	0,780	12	1	49228	30	0	00	RC
2	92	22	35	0,840	12	1	49228	35	0	00	RC
2	92	22	40	0,900	12	1	49228	40	0	00	RC

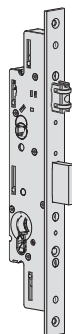

- Stainless steel faceplate 22x3 mm
- Deadbolt and roller
- Adjustable roller from 2,5 to 16,5 mm
- ON REQUEST:
 - Internal ragged extension bolts item 1.06441.00.0
 - Internal straight extension bolts item 1.06441.10.0
 - Pair of external bolt connectors item 1.06442.00.0
 - Extension bolts operated by internal rods item 1.06443.31.0
 - Extension bolts operated by external rods item 1.06443.36.0
 - Inserts for strike plates for locks 49250 series:
 - item 1.06141.70.0 for item 1.06463.16/17/34/35.0
 - item 1.06141.71.0 for item 1.06463.05/31/32/33.0
 - item 1.06141.86.0 for item 1.06461.30/35.0

2	22	25	0,720	12	1	49250	25	0	00	RC
2	22	30	0,780	12	1	49250	30	0	00	RC
2	22	35	0,840	12	1	49250	35	0	00	RC
2	22	40	0,900	12	1	49250	40	0	00	RC

• ADJUSTABLE METAL STRIKER

- for central lock:
 - 1.06463.05.0
 - 1.06463.16.0
 - 1.06463.17.0
 - 1.06463.31.0
 - 1.06463.32.0
 - 1.06463.33.0
 - 1.06463.34.0
 - 1.06463.35.0
 - 1.06461.07.0
 - 1.06461.17.0
 - 1.06461.30.0
 - 1.06461.35.0
- for divertor (pc.2)
 - 1.06465.05.0
 - 1.06465.06.0
 - 1.06465.07.0
 - 1.06465.21.0
 - 1.06465.22.0
 - 1.06465.23.0
 - 1.06465.24.0
 - 1.06465.25.0
 - 1.06461.12.0
 - 1.06461.22.0
 - 1.06461.34.0
 - 1.06461.39.0

Certification EN 14846:08

| 3 | X | 9 | 0 | 0 | M | 6 / 7 | 0 | 2 |



Multitop PRO

Technical features:

- Gear-operated system
- Case thickness 15.5 mm
- Off-phase prevention system
- Zinc-plated die-cast alloy case
- Zinc-plated steel case cover
- Latch interchangeable with nickel-plated roller and deadbolt
- Reversible latch or latch/piston
- Pre-set for additional locking points

Supplied as standard:

- Pair of nylon roses item 1.06012.01.0
- Pair of under-faceplate nylon spacers item 1.06141.65.0
- Threaded pins for fixing of extension bolts
- Lock and cylinder fixing screws
- Instruction sheet

On request:

- Special striker plates (see Vademecum)
- "Modular" roller assembly item 1.06000.00.0
- Cylinder protective rose item 1.06460.05.0
- Mechanical control button item 1.06110.15.0
- Threaded bushing for extension bolt item 1.06290.06.0

Certification:

- This lock series is certified according to the European standard EN 12209:16 (mechanical) e EN 14846:08 (electric) - Security class 6 (1000 Kg side thrust and 600 Kg front thrust resistance)
- Suitable for doors certified to EN 1627:2021 up to WK/RC 4 resistance class

Hand:
0 = Non-handed

Cylinder to be ordered separately



Type	Description	Throws	Centre Distance	Faceplate	Backset	Unit weight Kg	Pieces	ITEM			
								Type	Dim.	Hand	Spec.

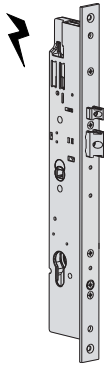

- Stainless steel faceplate 22x3 mm
- Deadbolt and latchbolt
- Adjustable latch and deadbolt from 10.5 to 16.5 mm. "deadlocking"
- CE 12V ac voltage
- Absorbed current 3.1 A

Certification EN 14846:08
| 3 | X | 9 | 0 | 0 | M | - | 0 | 2 |

85	22	25	0,980	1	1	19205 25 0
85	22	30	1,040	1	1	19205 30 0
85	22	35	1,100	1	1	19205 35 0
85	22	40	1,160	1	1	19205 40 0

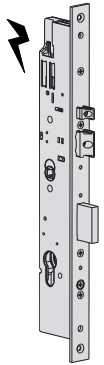

- Stainless steel faceplate 22x3 mm
- Deadbolt and latchbolt
- Adjustable latch and deadbolt from 10.5 to 16.5 mm. "deadlocking"
- CE 12V ac voltage
- Absorbed current 3.1 A

Certification EN 14846:08
| 3 | X | 9 | 0 | 0 | M | 6 | 0 | 2 |

2	85	22	25	1,010	1	1	19225 25 0
2	85	22	30	1,070	1	1	19225 30 0
2	85	22	35	1,000	1	1	19225 35 0
2	85	22	40	1,190	1	1	19225 40 0

- ON REQUEST:**
- Internal ragged extension bolts item 1.06441.00.0
 - Internal straight extension bolts item 1.06441.10.0
 - Internal extension bolts item 1.06441.20.0
 - Pair of external bolt connectors item 1.06442.00.0
 - Extension bolts operated by internal rods item 1.06443.31.0
 - Extension bolts operated by external rods item 1.06443.36.0
 - Internal extension rods hook side deadbolts item 1.06443.41.0
 - External extension rods hook side deadbolts item 1.06443.46.0

• ADJUSTABLE METAL STRIKER

- for central lock:
 - 1.06463.05.0
 - 1.06463.16.0
 - 1.06463.17.0
 - 1.06463.31.0
 - 1.06463.32.0
 - 1.06463.33.0
- for divertor (pc.2)
 - 1.06465.05.0
 - 1.06465.06.0
 - 1.06465.07.0
 - 1.06465.21.0
 - 1.06465.22.0
 - 1.06465.23.0

• ADJUSTABLE METAL STRIKER

- for central lock:
 - 1.06463.34.0
 - 1.06463.35.0
 - 1.06461.07.0
 - 1.06461.17.0
 - 1.06461.30.0
 - 1.06461.35.0
- for divertor (pc.2)
 - 1.06465.24.0
 - 1.06465.25.0
 - 1.06461.12.0
 - 1.06461.22.0
 - 1.06461.34.0
 - 1.06461.39.0



Technical features:

- Closed case, thickness 15.5 mm
- Latchbolt interchangeable with roller
- Steel cover
- Top and bottom adjustable faceplate
- 11 to 17 mm adjustable latchbolt
- 2.5 to 16.5 mm adjustable roller
- Pre-set for installation of microswitch on the divertor case.
- 8 mm square spindle
- DIN holes to fix the handle plate
- Zinc-plated cases and covers
- Nickel-plated deadbolts/roller

Supplied as standard:

- Pair of nylon roses item 1.06012.01.0.
- Lock and cylinder fixing screws
- Instructions sheet

On request:

- Modular roller assembly
- Adjustable metal strikers
- Additional extension bolts for 4th and 5th locking points, item 1.06449.10/11.0
- Kit for bolt extensions up to 3000
- Cylinder protective rose item 1.06460.05.0

Standards:

- in compliance with prEN 15685:10
- Grade 6 Security - 1000 kg lateral thrust and 600 kg frontal thrust.
- Grade 7 Security - like Grade 6 with use of protective plates series 06436
- Suitable for EN1627:2011 certified doors up to resistance class WK/RC4

Hand:
0 = Non-handed

Cylinder to be ordered separately



Multitop PRO RC

Type	Description	Locking points	Throws	Centre Distance	Faceplate	Backset	Unit weight	Pieces	ITEM			
									Type	Dim.	Hand	Fin.



• CENTRE DISTANCE 85 MM

- "Flat" adjustable faceplate 24 x 3 mm, in BLACK PAINTED steel, 2300 mm high
 - top adjustment 350 mm
 - bottom adjustment 150 mm
- 11 to 17 mm adjustable latchbolt
- 3 lateral deadbolts
- Nylon faceplate cover plugs

3	2	85	24	25	3,310	1	1	49526	25	0	00	RC
3	2	85	24	30	3,370	1	1	49526	30	0	00	RC
3	2	85	24	35	3,430	1	1	49526	35	0	00	RC
3	2	85	24	40	3,490	1	1	49526	40	0	00	RC

- "Flat" adjustable faceplate 24 x 3 mm in STAINLESS steel, 2300 mm high
 - top adjustment 350 mm
 - bottom adjustment 150 mm
- 11 to 17 mm adjustable latchbolt
- 3 lateral deadbolts

3	2	85	24	25	3,310	1	1	49726	25	0	00	RC
3	2	85	24	30	3,370	1	1	49726	30	0	00	RC
3	2	85	24	35	3,430	1	1	49726	35	0	00	RC
3	2	85	24	40	3,490	1	1	49726	40	0	00	RC

• CENTRE DISTANCE 92 MM

- "Flat" adjustable faceplate 24 x 3 mm in STAINLESS steel, 2300 mm high
 - top adjustment 350 mm
 - bottom adjustment 150 mm
- 11 to 17 mm adjustable latchbolt
- 3 lateral deadbolts

3	2	92	24	25	3,310	1	1	49728	25	0	00	RC
3	2	92	24	30	3,370	1	1	49728	30	0	00	RC
3	2	92	24	35	3,430	1	1	49728	35	0	00	RC
3	2	92	24	40	3,490	1	1	49728	40	0	00	RC

Type	Description	Locking points	Throws	Centre Distance	Faceplate	Backset	Unit weight 	Pieces 	ITEM					
									Type	Dim.	Hand	Fin.	Pers. Spec.	
	<ul style="list-style-type: none"> • CENTRE DISTANCE 85 MM • "U"-shaped adjustable faceplate 24 x 7 mm in BLACK PAINTED, 2300 mm high • top adjustment 350 mm • bottom adjustment 150 mm • 11 to 17 mm adjustable latchbolt • 3 lateral deadbolts • Nylon faceplate cover plugs 	3	2	85	24	25	3,310	1	1	49426	25	0	00	RC
		3	2	85	24	30	3,370	1	1	49426	30	0	00	RC
		3	2	85	24	35	3,430	1	1	49426	35	0	00	RC
		3	2	85	24	40	3,490	1	1	49426	40	0	00	RC
		3	2	85	24	25	3,310	1	1	49436	25	0	00	RC
		3	2	85	24	30	3,370	1	1	49436	30	0	00	RC
		3	2	85	24	35	3,430	1	1	49436	35	0	00	RC
		3	2	85	24	40	3,490	1	1	49436	40	0	00	RC
		3	2	85	24	25	3,310	1	1	49626	25	0	00	RC
		3	2	85	24	30	3,370	1	1	49626	30	0	00	RC
		3	2	85	24	35	3,430	1	1	49626	35	0	00	RC
		3	2	85	24	40	3,490	1	1	49626	40	0	00	RC
		3	2	85	24	25	3,310	1	1	49636	25	0	00	RC
		3	2	85	24	35	3,430	1	1	49636	30	0	00	RC
		3	2	85	24	35	3,430	1	1	49636	35	0	00	RC
		3	2	85	24	35	3,430	1	1	49636	40	0	00	RC
		3	2	92	24	25	3,310	1	1	49638	25	0	00	RC
		3	2	92	24	30	3,370	1	1	49638	30	0	00	RC
		3	2	92	24	35	3,430	1	1	49638	35	0	00	RC
		3	2	92	24	40	3,490	1	1	49638	40	0	00	RC

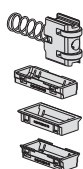

- Modular 2.5 to 15.5 mm adjustable roller assembly for lock series 49225 and 49228,
- Supplied as standard: nylon inserts item 1.06141. 70/ 70/71/86.0

0,060 12 1 06000 00 0

- ADJUSTABLE METAL STRIKER
- for central lock: for divertor (pc.2)
- 1.06463.05.0 1.06465.05.0
- 1.06463.16.0 1.06465.06.0
- 1.06463.17.0 1.06465.07.0
- 1.06463.67.0 1.06465.57.0
- 1.06463.68.0 1.06465.58.0

- ADJUSTABLE METAL STRIKER
- for central lock: for divertor (pc.2)
- 1.06463.82.0 1.06465.72.0
- 1.06463.83.0 1.06465.73.0
- 1.06463.84.0 1.06465.74.0
- 1.06463.85.0 1.06465.75.0
- 1.06461.30.0 1.06461.34.0
- 1.06461.35.0 1.06461.39.0

Certification EN 14846:08

| 3 | X | 9 | 0 | 0 | M | 6/7 | 0 | 2 |



Multitop PRO



Technical features:

- Gear-operated system
- Case 15.5 mm thick
- **Off-phase prevention system**
- Zinc-plated die-cast alloy case
- Zinc-plated steel case cover
- Latch interchangeable with nickel-plated roller and deadbolt
- 4th and 5th locking point pre-setting

Supplied as standard:

- Set of nylon roses 1.06012.01.0
- Lock and cylinder fixing screws
- Instruction sheet

On request:

- Special striker plates (see Vademecum)
- "MODULAR" roller item 1.06000.00.0
- Cylinder protective rose item 1.06460.05.0

- Mechanical control button item 1.06110.15.0
- Extension bolts for 4th and 5th locking points item 1.06449.10 - 1.06449.11
- Threaded pin for extension bolts with external rods item 1.06449.05.0

Hand:
0 = Non-handed

Cylinder to be ordered separately



Certification:

- This lock series is certified according to the European standard pr EN 15685:19 - (mechanically operated locks) and EN 14846:08 (electrically operated locks) - grade 6 Security (1,000 Kg side load and 600 Kg front thrust)
- Grade 7 Security with a drill-resistant plate series 06436
- Suitable for doors certified to EN 1627:2021 up to resistance class WK/RC 4

Type	Description	Locking points	Throws	Centre Distance	Faceplate	Backset	Unit weight	Pieces	ITEM			
									Type	Dim.	Hand	Fin.



• 85 MM CENTRE DISTANCE

- Black painted steel U-shaped adjustable faceplate 24x7 mm, 2300 mm.
- top adjustment 350 mm.
- bottom adjustment 150 mm.
- 10.5 to 16.5 adjustable latch and deadbolt. "deadlocking"
- 3 lateral deadbolts
- Faceplate cover nylon plugs
- CE 12 V ac voltage
- Absorbed current 3.1 A
- ON REQUEST:
- Top extension kit for doors up to 3000 mm high item 1.06444.47.0

3	2	85	24	25	3,520	1	1	19426	25	0
3	2	85	24	30	3,580	1	1	19426	30	0
3	2	85	24	35	3,640	1	1	19426	35	0
3	2	85	24	40	3,700	1	1	19426	40	0

- Black painted steel U-shaped adjustable faceplate 24x5 mm, 2300 mm.
- top adjustment 350 mm.
- bottom adjustment 150 mm.
- 10.5 to 16.5 adjustable latch and deadbolt. "deadlocking"
- 3 lateral deadbolts
- CE 12 V ac voltage
- Absorbed current 3.1 A
- ON REQUEST:
- Top extension kit for doors up to 3000 mm high item 1.06444.46.0

3	2	85	24	25	3,520	1	1	19436	25	0
3	2	85	24	30	3,580	1	1	19436	30	0
3	2	85	24	35	3,640	1	1	19436	35	0
3	2	85	24	40	3,700	1	1	19436	40	0

- Black painted steel U-shaped adjustable faceplate 24x7 mm, 2300 mm.
- top adjustment 350 mm.
- bottom adjustment 150 mm.
- 10.5 to 16.5 adjustable latch and deadbolt. "deadlocking"
- 3 lateral deadbolts
- CE 12 V ac voltage
- Absorbed current 3.1 A
- ON REQUEST:
- Top extension kit for doors up to 3000 mm high item 1.06444.67.0

3	2	85	24	25	3,520	1	1	19626	25	0
3	2	85	24	30	3,580	1	1	19626	30	0
3	2	85	24	35	3,640	1	1	19626	35	0
3	2	85	24	40	3,700	1	1	19626	40	0

- Black painted steel U-shaped adjustable faceplate 24x5 mm, 2300 mm.
- top adjustment 350 mm.
- bottom adjustment 150 mm.
- 10.5 to 16.5 adjustable latch and deadbolt. "deadlocking"
- 3 lateral deadbolts
- CE 12 V ac voltage
- Absorbed current 3.1 A
- ON REQUEST:
- Top extension kit for doors up to 3000 mm high item 1.06444.66.0

3	2	85	24	25	3,520	1	1	19636	25	0
3	2	85	24	30	3,580	1	1	19636	30	0
3	2	85	24	35	3,640	1	1	19636	35	0
3	2	85	24	40	3,700	1	1	19636	40	0

Type	Description	Locking points	Throws	Centre Distance	Faceplate	Backset	Unit weight Kg	Pieces	ITEM			
									Type	Dim.	Hand	Fin.



• **92 MM CENTRE DISTANCE**

- Stainless steel U-shaped adjustable faceplate 24x5 mm, 2300 mm.
- top adjustment 350 mm.
- bottom adjustment 150 mm.
- 10.5 to 16.5 adjustable latch and deadbolt. "deadlocking"
- 3 lateral deadbolts
- CE 12 V ac voltage
- Absorbed current 3.1 A
- ON REQUEST:
- Top extension kit for doors up to 3000 mm high item 1.06444.66.0

3	2	92	24	25	3,520	3	1	19638	25	0
3	2	92	24	30	3,580	3	1	19638	30	0
3	2	92	24	35	3,640	3	1	19638	35	0
3	2	92	24	40	3,700	3	1	19638	40	0

• **ADJUSTABLE METAL STRIKER**

- | | |
|---------------------|---------------------|
| • for central lock: | for divertor (pc.2) |
| 1.06463.05.0 | 1.06465.05.0 |
| 1.06463.16.0 | 1.06465.06.0 |
| 1.06463.17.0 | 1.06465.07.0 |
| 1.06463.31.0 | 1.06465.21.0 |
| 1.06463.32.0 | 1.06465.22.0 |
| 1.06463.33.0 | 1.06465.23.0 |
| 1.06463.34.0 | 1.06465.24.0 |
| 1.06463.35.0 | 1.06465.25.0 |
| 1.06461.07.0 | 1.06461.12.0 |
| 1.06461.17.0 | 1.06461.22.0 |
| 1.06461.30.0 | 1.06461.34.0 |
| 1.06461.35.0 | 1.06461.39.0 |

EN 14846:08 Certification

| 3 | X | 9 | 0 | 0 | M | 6/7 | 0 | 2 |

Type	Description	Locking points	Throws	Centre Distance	Faceplate	Backset	Unit weight Kg	Pieces	ITEM			
									Type	Dim.	Hand	Fin.



• 85 MM CENTRE DISTANCE

- Black painted steel U-shaped adjustable faceplate 24x3 mm, 2300 mm.
top adjustment 350 mm.
bottom adjustment 150 mm.
- 10.5 to 16.5 adjustable latch and deadbolt. "deadlocking"
- 3 lateral deadbolts
- Faceplate cover nylon plugs
- CE 12V ac voltage
- Absorbed current 3.1A
- ON REQUEST:
- Top extension kit for doors up to 3000 mm high item 1.06444.56.0

3	2	85	24	25	3,520	1	1	19526 25 0
3	2	85	24	30	3,580	1	1	19526 30 0
3	2	85	24	35	3,640	1	1	19526 35 0
3	2	85	24	40	3,700	1	1	19526 40 0

- Stainless steel flat adjustable faceplate 24x3 mm, 2300 mm.
top adjustment 350 mm.
bottom adjustment 150 mm.
- 10.5 to 16.5 adjustable latch and deadbolt. "deadlocking"
- 3 lateral deadbolts
- CE 12V ac voltage
- Absorbed current 3.1A
- ON REQUEST:
- Top extension kit for doors up to 3000 mm high item 1.06444.76.0

3	2	85	24	25	3,520	1	1	19726 25 0
3	2	85	24	30	3,580	1	1	19726 30 0
3	2	85	24	35	3,640	1	1	19726 35 0
3	2	85	24	40	3,700	1	1	19726 40 0

92 MM CENTRE DISTANCE

- Stainless steel flat adjustable faceplate 24x3 mm, 2300 mm.
top adjustment 350 mm.
bottom adjustment 150 mm.
- 10.5 to 16.5 adjustable latch and deadbolt. "deadlocking"
- 3 lateral deadbolts
- CE 12V ac voltage
- Absorbed current 3.1A
- ON REQUEST:
- Top extension kit for doors up to 3000 mm high item 1.06444.76.0

3	2	92	24	25	3,520	3	1	19728 25 0
3	2	92	24	30	3,580	3	1	19728 30 0
3	2	92	24	35	3,640	3	1	19728 35 0
3	2	92	24	40	3,700	3	1	19728 40 0

• ADJUSTABLE METAL STRIKER

- for central lock: for divertor (pc.2)
- 1.06463.05.0 1.06465.05.0
- 1.06463.16.0 1.06465.06.0
- 1.06463.17.0 1.06465.07.0
- 1.06463.31.0 1.06465.21.0
- 1.06463.32.0 1.06465.22.0
- 1.06463.33.0 1.06465.23.0
- 1.06463.34.0 1.06465.24.0
- 1.06463.35.0 1.06465.25.0
- 1.06461.07.0 1.06461.12.0
- 1.06461.17.0 1.06461.22.0
- 1.06461.30.0 1.06461.34.0
- 1.06461.35.0 1.06461.39.0

EN 14846:08 Certification

| 3 | X | 9 | 0 | 0 | M | 6/7 | 0 | 2 |

Type	Description	Locking points	Throws	Centre Distance	Faceplate	Backset	Unit weight Kg	Pieces	ITEM				
									Type	Dim.	Hand	Fin.	Pers.

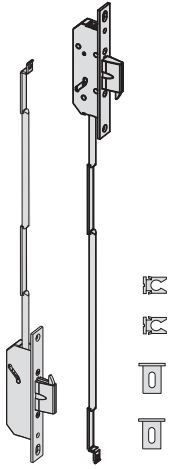

- Pair of lateral extension bolts operated by internal rods
- Horizontally sliding deadbolts with hardened steel inserts and hook bolt
- STAINLESS STEEL faceplate 22x3 mm
- Pre-set for 4th and 5th locking points
- Closed case
- SUPPLIED AS STANDARD:
 - Set of rods dia. 8 mm.
 - Set of faceplate spacers item 1.06141.65.0
 - Rod guide item 1.06224.00.0 (2 pcs)
- ON REQUEST:
 - Special strike plates (see Vademecum)
 - Internal straight extension bolts item 1.06441.10.0 for 4th and 5th locking points
 - Threaded pin item 1.06449.05.0 for fixing 4th and 5th locking point rods

1,000 1 1 06443 31 0

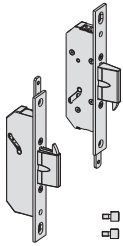

- Pair of lateral extension bolts operated by external rods
- Horizontally sliding deadbolts with hardened steel inserts and hook bolt
- STAINLESS STEEL faceplate 22x3 mm
- Pre-set for 4th and 5th locking points
- Closed case
- SUPPLIED AS STANDARD:
 - Set of external bolt connectors
 - Set of threaded pins
- ON REQUEST:
 - Special strike plates (see Vademecum)
 - Threaded pin item 1.06449.05.0 for fixing 4th and 5th locking point external extension bolts
 - External bolt connectors item 1.06442.00.0

0,766 1 1 06443 36 0

Type	Description	Locking points	Throws	Centre Distance	Faceplate	Backset	Unit weight 	Pieces 	ITEM			
									Type	Dim.	Hand	Fin.
	<ul style="list-style-type: none"> • Top extension kit for doors up to 3000 mm high • BLACK PAINTED STEEL U-shaped adjustable faceplate 24x5 mm, 700 mm 	19436, 49436	2	24	0,900	1	1 06444 46 0					
	<ul style="list-style-type: none"> • Top extension kit for doors up to 3000 mm high • BLACK PAINTED STEEL U-shaped adjustable faceplate 24x7 mm, 700 mm 	19426, 49426	2	24	0,900	1	1 06444 47 0					
	<ul style="list-style-type: none"> • Top extension kit for doors up to 3000 mm high • STAINLESS STEEL U-shaped adjustable faceplate 24x5 mm, 700 mm 	19636, 19638, 49636, 49638	2	24	0,900	1	1 06444 66 0					
	<ul style="list-style-type: none"> • Top extension kit for doors up to 3000 mm high • STAINLESS STEEL U-shaped adjustable faceplate 24x7 mm, 700 mm 	19626, 49626	2	24	0,900	1	1 06444 67 0					
	<ul style="list-style-type: none"> • Top extension kit for doors up to 3000 mm high • BLACK PAINTED STEEL flat adjustable faceplate 24x3 mm, 700 mm 	19526, 49526	2	24	0,900	1	1 06444 56 0					
	<ul style="list-style-type: none"> • Top extension kit for doors up to 3000 mm high • STAINLESS STEEL flat adjustable faceplate 24x3 mm, 700 mm 	19726, 19728, 49726, 49728	2	24	0,900	1	1 06444 76 0					
	<ul style="list-style-type: none"> • Threaded pin for fixing additional extension bolts for 4th and 5th locking points 					0,002	50	1 06449 05 0				

Type	Description	Locking points	Throws	Centre Distance	Faceplate	Backset	Unit weight Kg	Pieces	ITEM				
									Type	Dim.	Hand	Fin.	Pers.

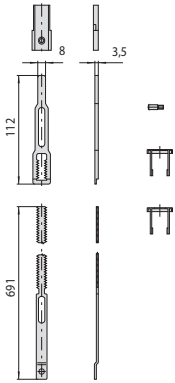

• Additional TOP extension bolt for installation with locks with 24x7 mm U-shaped faceplate for 19000 and 49000 series

0,187 6 1 06449 10 0

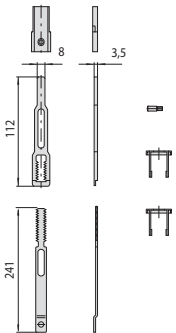

• Additional FLOOR extension bolt for installation with locks with 24x7 mm U-shaped faceplate for 19000 and 49000 series

0,135 6 1 06449 11 0



Technical features:

- Closed case, thickness 15.5 mm
- Latchbolt interchangeable with roller
- Steel cover
- Top and bottom adjustable faceplate
- 11 to 17 mm adjustable latchbolt
- 2.5 to 16.5 mm adjustable roller
- Pre-set for installation of microswitch on the divertor case.
- 8 mm square spindle
- DIN holes to fix the handle plate
- Stainless steel faceplate
- Zinc-plated cases and covers
- Nickel-plated deadbolts/roller

Supplied as standard:

- Pair of nylon roses item 1.06012.01.0.
- Lock and cylinder fixing screws
- Instructions sheet

On request:

- Modular roller assembly
- Euro profile cylinder
- Adjustable metal strikers
- Cylinder protective rose item 1.06460.05.0

Certifications:

- in compliance with prEN 15685:10
- Grade 6 Security - 1000 kg lateral thrust and 600 kg frontal thrust.
- Grade 7 Security - like Grade 6 with use of protective plates series 06436
- Suitable for EN1627:2011 certified doors up to resistance class WK/RC4.

Hand:
0 = Non-handed

Cylinder to be ordered separately



Type	Description	Locking points	Throws	Centre Distance	Faceplate	Backset	Unit weight Kg	Pieces	ITEM			
									Type	Dim.	Hand	Fin.

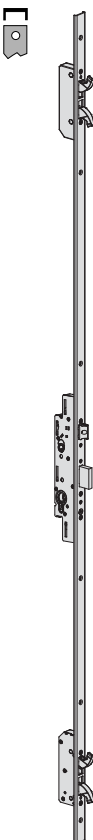

- **CENTRE DISTANCE 85 MM**
- "U"-shaped adjustable faceplate 24 x 5 mm in STAINLESS steel, 2300 mm high
 - top adjustment 350 mm
 - bottom adjustment 150 mm
- 11 to 17 mm adjustable latchbolt
- 4 hooks with hardened steel inserts.

3	2	85	24	25	3,310	1	1	1	49656	25	0	00	RC
3	2	85	24	30	3,370	1	1	1	49656	30	0	00	RC
3	2	85	24	35	3,430	1	1	1	49656	35	0	00	RC
3	2	85	24	40	3,490	1	1	1	49656	40	0	00	RC

- **CENTRE DISTANCE 92 MM**
- "U"-shaped adjustable faceplate 24 x 5 mm in STAINLESS steel, 2300 mm high
 - top adjustment 350 mm
 - bottom adjustment 150 mm
- 11 to 17 mm adjustable latchbolt
- 4 hooks with hardened steel inserts

3	2	92	24	25	3,310	1	1	1	49658	25	0	00	RC
3	2	92	24	30	3,370	1	1	1	49658	30	0	00	RC
3	2	92	24	35	3,430	1	1	1	49658	35	0	00	RC
3	2	92	24	40	3,490	1	1	1	49658	40	0	00	RC

Type	Description	Locking points	Throws	Centre Distance	Faceplate	Backset	Unit weight 	Pieces 	ITEM				
									Type	Dim.	Hand	Fin.	Pers. Spec.



• **CENTRE DISTANCE 85 MM**

- "Flat" adjustable faceplate 24 x 3 mm. in STAINLESS steel,, height 2300 mm.
- top adjustment 350 mm
- bottom adjustment 150 mm
- 11 to 17 mm adjustable latchbolt
- 4 hooks with hardened steel inserts.

3	2	85	24	25	3,310	1	1	49746	25	0	00	RC
3	2	85	24	30	3,370	1	1	49746	30	0	00	RC
3	2	85	24	35	3,430	1	1	49746	35	0	00	RC
3	2	85	24	40	3,490	1	1	49746	40	0	00	RC

• **CENTRE DISTANCE 92 MM**

- "Flat" adjustable faceplate 24 x 3 mm. in STAINLESS steel,, height 2300 mm.
- top adjustment 350 mm
- bottom adjustment 150 mm
- 11 to 17 mm adjustable latchbolt
- 4 hooks with hardened steel inserts.

3	2	92	24	25	3,310	1	1	49748	25	0	00	RC
3	2	92	24	30	3,370	1	1	49748	30	0	00	RC
3	2	92	24	35	3,430	1	1	49748	35	0	00	RC
3	2	92	24	40	3,490	1	1	49748	40	0	00	RC

• **ADJUSTABLE METAL STRIKER**

- | | |
|---------------------|---------------------|
| • for central lock: | for divertor (pc.2) |
| 1.06463.05.0 | 1.06465.05.0 |
| 1.06463.16.0 | 1.06465.06.0 |
| 1.06463.17.0 | 1.06465.07.0 |
| 1.06463.31.0 | 1.06465.21.0 |
| 1.06463.32.0 | 1.06465.22.0 |
| 1.06463.33.0 | 1.06465.23.0 |
| 1.06463.34.0 | 1.06465.24.0 |
| 1.06463.35.0 | 1.06465.25.0 |
| 1.06461.07.0 | 1.06461.12.0 |
| 1.06461.17.0 | 1.06461.22.0 |
| 1.06461.30.0 | 1.06461.34.0 |
| 1.06461.35.0 | 1.06461.39.0 |

Certification EN 14846:08

| 3 | X | 9 | 0 | 0 | M | 6/7 | 0 | 2 |



Technical features:

- Operated by gear mechanism
- Case thickness 15.5 mm
- Closed case
- Latchbolt interchangeable with roller
- Case in pressure die-cast metal
- Steel cover
- Top and bottom adjustable faceplate
- 11 to 17 mm adjustable latchbolt
- 2.5 to 15.5 mm adjustable roller
- 10.5 to 16.5 mm adjustable latchbolt and deadbolt (electric versions)
- Latchbolt with anti-burglary device (electric versions)
- 10 mm thick hooks with 25 mm protrusion
- Protective plate for grade 7 item 1.06436.10/11.0
- Microswitch can be installed on the divertor case
- 8 mm square spindle

- DIN holes to fix handle plate
- CE 12V AC (electric versions)

Supplied as standard:

- Pair of nylon protective roses item 1.06012.01.0
- Lock and cylinder fixing screws
- Instruction sheet

On request:

- Modular roller assembly item 1.06000.00.0
- Adjustable metal strikes (see special Vademecum)
- Cylinder protective rose item 1.06460.05.0
- Button item 1.06110.15.0 (electric locks)
- Pair of electric contacts item 1.06511.00.0

Certifications:

- European Standard pr EN 15685:19 (mechanical) and EN 14846:08 (electric)
- Grade 6 Security
- Grade 7 Security using protective plates for the lock and divertors series 06436
- Suitable for EN 1627:2021 certified doors up to resistance class WK/RC4

MultitopMAX

Type	Description	Locking points	Throws	Centre Distance	Faceplate	Backset	Unit weight	Pieces	ITEM			
									Type	Dim. Hand	Fin.	Pers. Spec.

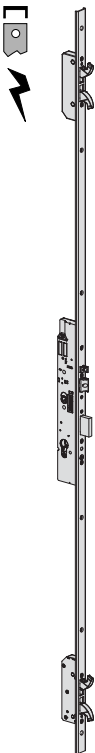

- CENTRE DISTANCE 85 MM
- 'U'-shaped adjustable faceplate 24 x 5 mm.
In stainless steel, height 2300 mm.
- top adjustment 350 mm.
- bottom adjustment 150 mm.
- 10.5 to 16.5 mm adjustable deadlocking latchbolt and deadbolt.
- 4 hooks with hardened STEEL INSERTS.
- CE 12V AC voltage
- Certification EN 14846:08

3	2	85	24	25	3,520	1	1	19656 25 0
3	2	85	24	30	3,580	1	1	19656 30 0
3	2	85	24	35	3,640	1	1	19656 35 0
3	2	85	24	40	3,700	1	1	19656 40 0

| 3 | X | 9 | 0 | 0 | M | 6/7 | 0 | 2 |

- ADJUSTABLE METAL STRIKER
 - Central cylinder item: divertor (pc.2) item
- | | |
|--------------|--------------|
| 1.06463.05.0 | 1.06465.05.0 |
| 1.06463.16.0 | 1.06465.06.0 |
| 1.06463.17.0 | 1.06465.07.0 |
| 1.06463.31.0 | 1.06465.21.0 |
| 1.06463.32.0 | 1.06465.22.0 |
| 1.06463.33.0 | 1.06465.23.0 |
| 1.06463.34.0 | 1.06465.24.0 |
| 1.06463.35.0 | 1.06465.25.0 |
| 1.06461.07.0 | 1.06461.12.0 |
| 1.06461.17.0 | 1.06461.22.0 |
| 1.06461.30.0 | 1.06461.34.0 |
| 1.06461.35.0 | 1.06461.39.0 |

Type	Description	Locking points Throws	Centre Distance	Faceplate	Backset	Unit weight Kg	Pieces	ITEM			
								Type	Dim.	Hand	Fin. Pers. Spec.

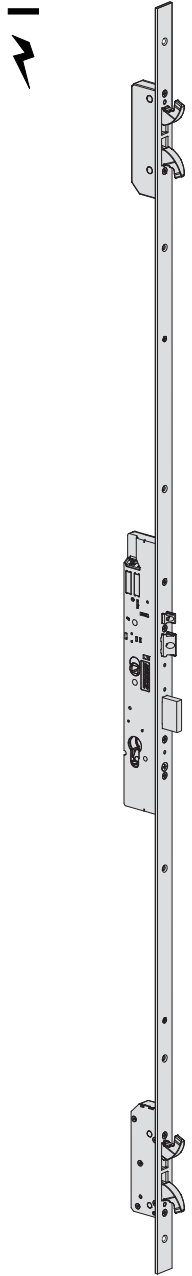

- CENTRE DISTANCE 85 MM
- Stainless steel "flat" adjustable faceplate 24 x 3 mm, height 2300 mm.
 - top adjustment 350 mm.
 - bottom adjustment 150 mm.
- 10.5 to 16.5 mm adjustable deadlocking latchbolt and deadbolt.
- 4 hooks with hardened STEEL INSERTS.
- 12V AC voltage
- Absorbed current 3.1 A

3	2	85	24	25	3,520	1	1	19746	25	0
3	2	85	24	30	3,580	1	1	19746	30	0
3	2	85	24	35	3,640	1	1	19746	35	0
3	2	85	24	40	3,700	1	1	19746	40	0

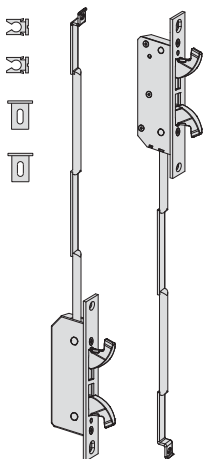

Certification EN 14846:08

| 3 | X | 9 | 0 | 0 | M | 6/7 | 0 | 2 |

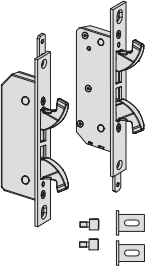
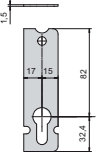
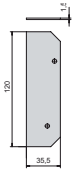

- Pair of lateral locking points operated by internal rods
- 4 hooks with hardened STEEL INSERTS.
- Stainless steel faceplate 22 x 3 mm
- Closed case
- SUPPLIED AS STANDARD:
 - Pair of rods diameter 8 mm.
 - Pair of faceplate spacers item 1.06141.65.0
 - Rod guide item 1.06224.00.0 (2 pcs)
- ON REQUEST:
 - Special strikes (see Vademecum)

1,000	1	1	06443	41	0
• ADJUSTABLE METAL STRIKER					
• Central cylinder item: divertor (pc.2) item					
1.06463.05.0					1.06465.05.0
1.06463.16.0					1.06465.06.0
1.06463.17.0					1.06465.07.0
1.06463.31.0					1.06465.21.0
1.06463.32.0					1.06465.22.0
1.06463.33.0					1.06465.23.0
1.06463.34.0					1.06465.24.0
1.06463.35.0					1.06465.25.0
1.06461.07.0					1.06461.12.0
1.06461.17.0					1.06461.22.0
1.06461.30.0					1.06461.34.0
1.06461.35.0					1.06461.39.0

Type	Description	Locking points	Throws	Centre Distance	Faceplate	Backset	Unit weight Kg	Pieces	ITEM			
									Type	Dim.	Hand	Fin.
	<ul style="list-style-type: none"> • Pair of lateral locking points operated by external rods • 4 hooks with hardened STEEL INSERTS • Stainless steel faceplate 22 x 3 mm • Closed case • SUPPLIED AS STANDARD: <ul style="list-style-type: none"> - Pair of external bolt controls - Pair of faceplate spacers item 1.06141.65.0 - Pair of threaded pins • ON REQUEST: <ul style="list-style-type: none"> Special strikes (see Vademecum) 						0,766	1	1	06443	46	0
	<ul style="list-style-type: none"> • Lock protective plate to increase drill resistance (grade 7 prEN 15685 : 19) for 19000 and 49000 series 						0,100	6	1	06436	10	0
	<ul style="list-style-type: none"> • Divertors protective plate to increase drill resistance (grade 7 prEN 15685 : 19) for series 19000 and 49000 						0,100	6	1	06436	11	0
	<ul style="list-style-type: none"> • Microswitch to be used with divertors of locks 19000 and 49000 series 						0,020	1	1	06195	08	0



3 SCROCCHI

Technical features:

- Case thickness 15.5 mm
- Closed case
- Steel case and cover
- Top and bottom adjustable faceplate
- Three 11-mm thick latchbolts
- 8-mm thick deadbolts with 20 mm protrusion
- 8 mm square spindle
- DIN holes to fix handle plate

Supplied as standard:

- Pair of nylon protective roses item 1.06012.01.0
- Cylinder and rose fixing screws
- Instruction sheet
- Nylon faceplate cover plugs

On request:

- Adjustable metal strikes (see special Vademecum)

Finishes:

- Zinc-plated cases and covers
- Zinc-plated steel faceplate with corrosion resistance up to 480 hours
- Zinc-plated latchbolt and deadbolts

Standards:

- Grade 3 Security in compliance with pr EN15685:19.

Cylinder to be ordered separately



Type	Description	Locking points	Throws	Centre Distance	Faceplate	Backset	Unit weight	Pieces	ITEM			
									Type	Dim.	Hand	Fin.

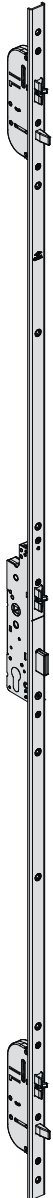

- 3 LATCHBOLTS
- 'U'-shaped adjustable faceplate 24 x 6 mm.
In ZINC-PLATED steel, height 2300 mm.
- top adjustment 350 mm.
- bottom adjustment 150 mm.
- 3 lateral latchbolts

3	2	92	24	35	3,800	1	1	48816 35 0
3	2	92	24	40	3,820	1	1	48816 40 0

- ADJUSTABLE METAL STRIKER
 - for central lock (pc.1) + for divertor (pc.2)
- | item | Profile |
|----------------|--------------------------------|
| 1.06461.03.1/2 | "steel" profile |
| 1.06461.04.1/2 | for divertor |
| 1.06461.27.1/2 | "R" type profile (overlapping) |
| 1.06461.43.0 | "European groove" profile |

Type	Description	Locking points	Throws	Centre Distance	Faceplate	Backset	Unit weight 	Pieces 	ITEM														
									Type	Dim.	Hand	Fin.	Pers.	Spec.									
	<ul style="list-style-type: none"> • 3 LATCHBOLTS 	3	2	92	24	35	3,800	1	1	48916	35	0											
	<ul style="list-style-type: none"> • "Flat" adjustable faceplate 24 x 3 mm. In ZINC-PLATED steel, height 2300 mm. <ul style="list-style-type: none"> - top adjustment 350 mm. - bottom adjustment 150 mm. • 3 lateral latchbolts 	3	2	92	24	40	3,820	1	1	48916	40	0											
	<ul style="list-style-type: none"> • ADJUSTABLE METAL STRIKER • for central lock (pc.1) + for divertor (pc.2) 																						
	<table border="0"> <tr> <td>item</td> <td>Profile</td> </tr> <tr> <td>1.06461.03.1/2</td> <td>"steel" profile</td> </tr> <tr> <td>1.06461.04.1/2</td> <td>for divertor</td> </tr> <tr> <td>1.06461.27.1/2</td> <td>"R" type profile (overlapping)</td> </tr> <tr> <td>1.0646143.0</td> <td>"European groove" profile</td> </tr> </table>	item	Profile	1.06461.03.1/2	"steel" profile	1.06461.04.1/2	for divertor	1.06461.27.1/2	"R" type profile (overlapping)	1.0646143.0	"European groove" profile												
item	Profile																						
1.06461.03.1/2	"steel" profile																						
1.06461.04.1/2	for divertor																						
1.06461.27.1/2	"R" type profile (overlapping)																						
1.0646143.0	"European groove" profile																						

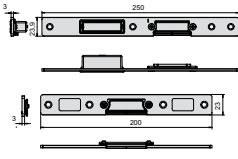
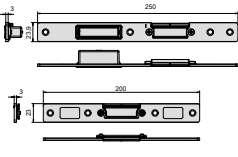
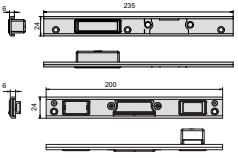
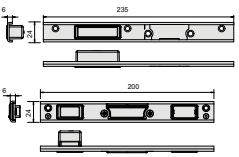
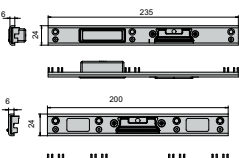
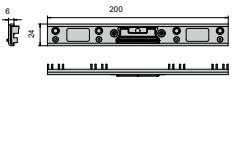
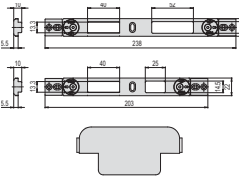

Type	Description	For locks series	Unit weight Kg	Pieces	ITEM				
					Type	Dim.	Hand	Fin.	Pers. Spec.
	<ul style="list-style-type: none"> • Zinc-plated steel strike kit 24 x 3 mm RH for "steel" profile • SUPPLIED AS STANDARD - Strike for central lock 1 pc - Strike for divertors 2 pcs 	48816, 48916	0,310	6	1	06461	03	1	
	<ul style="list-style-type: none"> • Zinc-plated steel strike kit 24 x 3 mm LH for "steel" profile • SUPPLIED AS STANDARD - Strike for central lock 1 pc - Strike for divertors 2 pcs 	48816, 48916	0,310	6	1	06461	03	2	
	<ul style="list-style-type: none"> • Zinc-plated steel 'U'-shaped strike kit 24 x 6 mm RH for "door" profile • SUPPLIED AS STANDARD: - Strike for central lock 1 pc - Strike for divertors 2 pcs 	48816, 48916	0,310	6	1	06461	04	1	
	<ul style="list-style-type: none"> • Zinc-plated steel 'U'-shaped strike kit 24 x 6 mm LH for "door" profile • SUPPLIED AS STANDARD: - Strike for central lock 1 pc - Strike for divertors 2 pcs 	48816, 48916	0,310	6	1	06461	04	2	
	<ul style="list-style-type: none"> • Zinc-plated steel strike kit RH for "R" type profile (overlapping) • SUPPLIED AS STANDARD: - Strike for central lock 1 pc - Strike for divertors 2 pcs 	48816, 48916	0,310	6	1	06461	27	1	
	<ul style="list-style-type: none"> • Zinc-plated steel strike kit LH for "R" type profile (overlapping) • SUPPLIED AS STANDARD: - Strike for central lock 1 pc - Strike for divertors 2 pcs 	48816, 48916	0,310	6	1	06461	27	2	
	<ul style="list-style-type: none"> • REPLACING ITEM 1.06461.23.0 • Reversible strike kit for "European groove" profile • SUPPLIED AS STANDARD - Strike for central lock 1 pc - Strike for divertors 2 pcs - Stainless steel - Lateral adjustment 2.5 mm - Nylon cover 	48816, 48916	0,310	6	1	06461	43	0	



Technical features:

- Zinc-plated steel case
- Nickel-plated latch, roller and deadbolt
- Latch or reversible latch/bolt (where this is provided for)
- Voltage 12 V ac
- Current absorption 3,1A

Supplied as standard:

- Pair of nylon roses item 1.06012.01.0
- Lock and cylinder fixing screws
- Instruction sheet

On request:

- Special striker plates (see Vademecum)
- Cylinder with pin key series 02400
- Cylinder protective rose item 1.06460.00.0
- Mechanical control button item 1.06110.15.0

Certification:

- This lock series is certified according to the European standard pr EN 15685:19 (mechanical) e EN14846:08 (electric)
- Security class 4 (700 Kg side thrust and 500 Kg front thrust resistance)

Hand:

0 = Non-handed

Cylinder to be ordered separately



Type	Description	Locking points	Throws	Centre Distance	Faceplate	Backset	Unit weight	Pieces	ITEM			
									Type	Dim.	Hand	Fin.

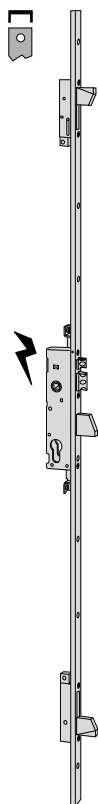

- Black painted steel adjustable U-shaped faceplate 24 x 7 mm, 2,600 mm.
upper adjustment 650 mm.
lower adjustment 150 mm.
- 10.5 to 16.5 adjustable latch bolt and bolt
- 3 lateral deadbolts
- Faceplate cover nylon plugs
- 12 V ca

3	1	85	24	25	3,500	1	1	16425	25	0
3	1	85	24	30	3,500	1	1	16425	30	0
3	1	85	24	35	3,500	1	1	16425	35	0

- Stainless steel adjustable U-shaped faceplate 24 x 7 mm., 2.300 mm.
upper adjustment 350 mm.
lower adjustment 150 mm.
- 10.5 to 16.5 mm. adjustable latch and piston
- 3 lateral deadbolts
- 12 V ca CE

3	1	85	24	25	3,780	1	1	16625	25	0
3	1	85	24	30	3,800	1	1	16625	30	0
3	1	85	24	35	3,820	1	1	16625	35	0

Certification EN 14846:08

| 3 | X | 8 | A | 0 | F | 4 | 0 | 0 |

Type	Description	Locking points	Throws	Centre Distance	Faceplate	Backset	Unit weight 	Pieces 	ITEM				
									Type	Dim.	Hand	Fin.	Pers. Spec.

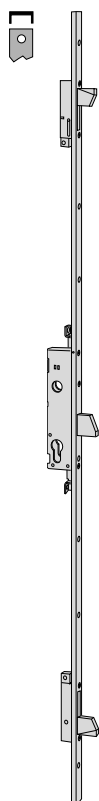

- Black lacquered steel adjustable U-shaped faceplate
24 x 7 mm., 2.600 mm.
upper adjustment 650 mm.
lower adjustment 150 mm.
- 3 lateral deadbolts
- Nylon faceplate cover plugs

Certification pr EN 15685:19

| 3 | C | 8 | A | 0 | F | 4 | 0 | 0 |

3	1	24	25	3,600	1	1	46420 25 0
3	1	24	30	3,620	1	1	46420 30 0
3	1	24	35	3,640	1	1	46420 35 0

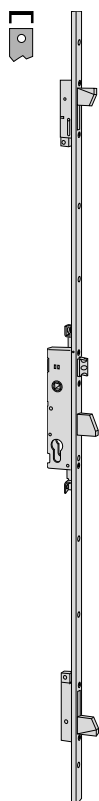

- Black lacquered steel adjustable U-shaped faceplate
24 x 7 mm., 2.600 mm.
upper adjustment 650 mm.
lower adjustment 150 mm.
- 11 to 17 mm. adjustable latch and piston
- 3 lateral deadbolts
- Nylon faceplate cover plugs

- Stainless steel adjustable U-shaped faceplate
24 x 7 mm., 2.300 mm.
upper adjustment 350 mm.
lower adjustment 150 mm.
- 11 to 17 mm. adjustable latch
- 3 lateral deadbolts

Certification pr EN 15685:19

| 3 | C | 8 | A | 0 | F | 4 | 0 | 0 |

3	1	85	24	25	3,500	1	1	46425 25 0
3	1	85	24	30	3,500	1	1	46425 30 0
3	1	85	24	35	3,500	1	1	46425 35 0

3	1	85	24	25	3,000	1	1	46625 25 0
3	1	85	24	30	3,000	1	1	46625 30 0
3	1	85	24	35	3,640	1	1	46625 35 0

Type	Description	Locking points	Throws	Centre Distance	Faceplate	Backset	Unit weight Kg	Pieces	ITEM			
									Type	Dim.	Hand	Fin.

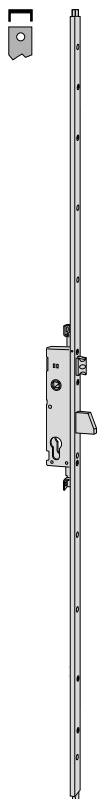

- Black lacquered steel adjustable U-shaped faceplate
24 x 7 mm., 2.600 mm.
upper adjustment 650 mm.
lower adjustment 150 mm.
- 11 to 17 mm. adjustable latch and piston
- 1 lateral deadbolt
- Vertical extension bolts
- Nylon faceplate cover plugs

1	1	85	24	25	3,500	1	1	46445	25	0
1	1	85	24	30	3,500	1	1	46445	30	0
1	1	85	24	35	3,240	1	1	46445	35	0

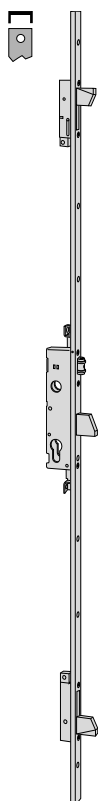

- Black lacquered steel adjustable U-shaped faceplate
24 x 7 mm., 2.600 mm.
upper adjustment 650 mm.
lower adjustment 150 mm.
- 2.5 to 16.5 mm. adjustable roller
- 3 lateral deadbolts
- Nylon faceplate cover plugs

3	1	24	25	3,600	1	1	46450	25	0
3	1	24	30	3,500	1	1	46450	30	0
3	1	24	35	3,640	1	1	46450	35	0

- Stainless steel adjustable U-shaped faceplate
24 x 7 mm., 2.300 mm.
upper adjustment 350 mm.
lower adjustment 150 mm.
- 2.5 to 16.5 mm. adjustable roller
- 3 lateral deadbolts

3	1	24	25	3,600	1	1	46650	25	0
3	1	24	30	3,620	1	1	46650	30	0
3	1	24	35	3,640	1	1	46650	35	0

Certification pr EN 15685:19

| 3 | C | 8 | A | 0 | F | 4 | 0 | 0 |

Type	Description	Locking points Throws	Centre Distance	Faceplate	Backset	Unit weight Kg	Pieces	ITEM			
								Type	Dim.	Hand	Fin.

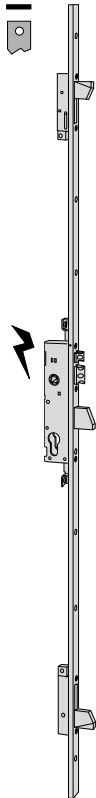

- Black lacquered steel adjustable flat faceplate 24 x 3 mm., 2.600 mm.
upper adjustment 650 mm.
lower adjustment 150 mm.
- 10.5 to 16.5 mm. adjustable latch and piston
- 3 lateral deadbolts
- Nylon faceplate cover plug

3	1	85	24	25	3,500	1	1	16525	25	0
3	1	85	24	30	3,500	1	1	16525	30	0
3	1	85	24	35	3,500	1	1	16525	35	0

- Stainless steel adjustable flat faceplate 24 x 3 mm., 2.300 mm.
upper adjustment 350 mm.
lower adjustment 150 mm.
- 10.5 to 16.5 mm. adjustable latch and piston
- 3 lateral deadbolts

3	1	85	24	25	3,780	1	1	16725	25	0
3	1	85	24	30	3,800	1	1	16725	30	0
3	1	85	24	35	3,820	1	1	16725	35	0

Certification EN 14846:08

| 3 | X | 8 | A | 0 | F | 4 | 0 | 0 |

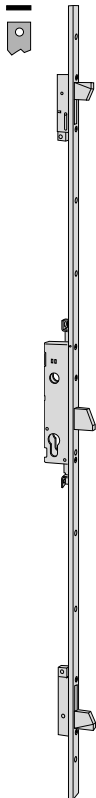

- Black lacquered steel adjustable flat faceplate 24 x 3 mm., 2.600 mm.
upper adjustment 650 mm.
lower adjustment 150 mm.
- 3 lateral deadbolts
- Nylon faceplate cover plugs

3	1	24	25	3,600	1	1	46520	25	0
3	1	24	30	3,620	1	1	46520	30	0
3	1	24	35	3,640	1	1	46520	35	0

Certification pr EN 15685:19

| 3 | C | 8 | A | 0 | F | 4 | 0 | 0 |

Type	Description	Locking points	Throws	Centre Distance	Faceplate	Backset	Unit weight Kg	Pieces	ITEM			
									Type	Dim.	Hand	Fin.

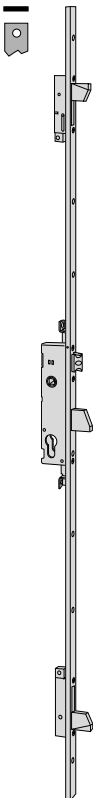

- Black lacquered steel adjustable flat faceplate
24 x 3 mm., 2.600 mm.
upper adjustment 650 mm.
lower adjustment 150 mm.
- 11 to 17 mm. adjustable latch
- 3 lateral deadbolts
- Nylon faceplate cover plugs

3	1	85	24	25	3,600	1	1	46525	25	0
3	1	85	24	30	3,500	1	1	46525	30	0
3	1	85	24	35	3,500	1	1	46525	35	0

- Stainless steel adjustable flat faceplate
24 x 3 mm., 2.300 mm.
upper adjustment 350 mm.
lower adjustment 150 mm.
- 11 to 17 mm. adjustable latch
- 3 lateral deadbolts

3	1	85	24	25	3,600	1	1	46725	25	0
3	1	85	24	30	3,620	1	1	46725	30	0
3	1	85	24	35	3,640	1	1	46725	35	0

Certification pr EN 15685:19

| 3 | X | 8 | A | 0 | F | 4 | 0 | 0 |

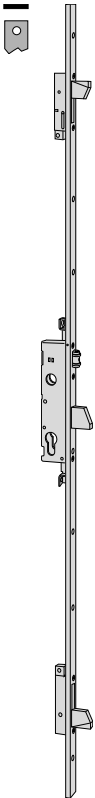

- Black lacquered steel adjustable flat faceplate
24 x 3 mm., 2.600 mm.
upper adjustment 650 mm.
lower adjustment 150 mm.
- 2.5 to 16.5 mm. adjustable roller
- 3 lateral deadbolts
- Nylon faceplate cover plugs

3	1	24	25	3,500	1	1	46550	25	0
3	1	24	30	3,500	1	1	46550	30	0
3	1	24	35	3,500	1	1	46550	35	0

- Stainless steel adjustable flat faceplate
24 x 3 mm., 2.300 mm.
upper adjustment 350 mm.
lower adjustment 150 mm.
- 2.5 to 16.5 mm. adjustable roller
- 3 lateral deadbolts

3	1	24	25	3,600	1	1	46750	25	0
3	1	24	30	3,620	1	1	46750	30	0
3	1	24	35	3,640	1	1	46750	35	0

Certification pr EN 15685:19

| 3 | C | 8 | A | 0 | F | 4 | 0 | 0 |



Technical features:

- Zinc-plated steel case.
- Stainless steel faceplate
- Can be fitted with additional locking points
- Spindle for operating the deadbolt and reloading pins, which can be locked by key

Hand:

0 = Non-handed

Cylinder to be ordered separately



Supplied as standard:

- Set of nylon roses item 1.06012.01.0
- Set of faceplate spacers item 1.06141.65.0
- Threaded pins for fixing the extension bolts
- Lock and cylinder fixing screws
- Instruction sheet

On request:

- Specific striker (see Vademecum)
- Cylinder protective rose item 1.06460.00.0

Type	Description	Throws	Centre Distance	Faceplate	Backset	Unit weight 	Pieces 	ITEM				
								Type	Dim.	Hand	Fin.	Pers. Spec.

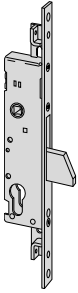

- Nickel-plated deadbolt
- ON REQUEST:
Cross-key cylinder item 1.02400.10.0
Internal ragged extension bolts item 1.06441.00.0
Internal straight extension bolts item 1.06441.10.0
External bolt connectors item 1.06442.00.0
extension bolts operated by internal rods item 1.06443.00.0
extension bolts operated by external rods item 1.06443.05.0
Internal extension rods hook side deadbolts item 1.06443.41.0
External extension rods hook side deadbolts item 1.06443.46.0

1	85	22	25	0,620	1	1	46200 25 0
1	85	22	30	0,640	1	1	46200 30 0
1	85	22	35	0,610	1	1	46200 35 0

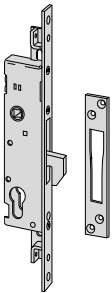

- Nickel-plated hook
- Stainless steel striker item 1.06459.01.0
- ON REQUEST:
Cross-key cylinder item 1.02400.10.0
Internal ragged extension bolts item 1.06441.00.0
Internal straight extension bolts item 1.06441.10.0
External bolt connectors item 1.06442.00.0
extension bolts operated by internal rods item 1.06443.00.0
extension bolts operated by external rods item 1.06443.05.0
Internal extension rods hook side deadbolts item 1.06443.41.0
External extension rods hook side deadbolts item 1.06443.46.0

1	85	22	25	0,650	1	1	46265 25 0
1	85	22	30	0,670	1	1	46265 30 0
1	85	22	35	0,693	1	1	46265 35 0



- No frontal closure
- ON REQUEST:
Cross-key cylinder item 1.02400.10.0
Internal ragged extension bolts item 1.06441.00.0
Internal straight extension bolts item 1.06441.10.0
External bolt connectors item 1.06442.00.0
extension bolts operated by internal rods item 1.06443.00.0
extension bolts operated by external rods item 1.06443.05.0
Internal extension rods hook side deadbolts item 1.06443.41.0
External extension rods hook side deadbolts item 1.06443.46.0

85	22	25	0,570	1	1	46275 25 0
85	22	30	0,540	1	1	46275 30 0
85	22	35	0,560	1	1	46275 35 0



Technical features:

- Zinc-plated steel case
- Stainless steel faceplate
- Nickel-plated latch, roller, bolt and hook bolt
- Latch or reversible latch/bolt (if this is provided for)
- Current absorption 3,1A
- Voltage 12 V ac CE

Supplied as standard:

- Set of faceplate spacers item 1.06141.65.0
- Lock and cylinder fixing screws
- Instruction sheet

On request:

- Special striker plates (see Vademecum)
- Cylinder protective rose item 1.06460.00.0
- Cylinder with pin key series 02400
- Mechanical control button item 1.06110.10.0
- Threaded bushing item 1.06290.05 for extension bolt

Certification:

- This lock series is certified according to the European standard EN 12209:16 - Security class 3 (500 Kg side thrust and 400 Kg front thrust resistance)
- Suitable for doors certified to EN1627:2021 up to WK/RC 2 resistance class

Hand:
0 = Non-handed

Cylinder to be ordered separately 

Type	Description	Throws	Centre Distance	Faceplate	Backset	Unit weight 		ITEM			
								Type	Dim.	Hand	Fin.

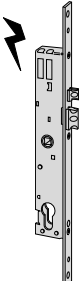

- Only latch
- 10.5 to 16.5 mm. adjustable latch and piston
- Set of nylon roses item 1.06012.01.0

Certification EN 12209:16

| 3 | X | 8 | 0 | 0 | F | - | H |

85	22	25	0,764	1	1	16205	25	0
85	22	30	0,788	1	1	16205	30	0
85	22	35	0,833	1	1	16205	35	0

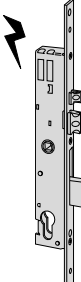

- deadbolt and latch
- 10.5 to 16.5 mm. adjustable latch and piston
- Set of nylon roses item 1.06012.01.0

1	85	22	25	0,798	1	1	16215	25	0
1	85	22	30	0,843	1	1	16215	30	0
1	85	22	35	0,883	1	1	16215	35	0

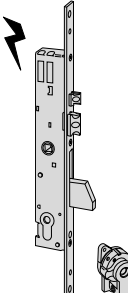

- Cross-key cylinder with 3 keys
- deadbolt and latch
- 10.5 to 16.5 mm. adjustable latch and piston
- Set of nylon roses item 1.06002.00.0

1	85	22	25	0,907	1	1	16217	25	0
1	85	22	30	0,953	1	1	16217	30	0
1	85	22	35	0,988	1	1	16217	35	0

Type	Description	Throws	Centre Distance	Faceplate	Backset	Unit weight Kg	Pieces	ITEM			
								Type	Dim.	Hand	Fin.

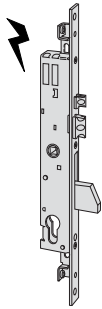

- Deadbolt and latch
- 10.5 to 16.5 mm. adjustable latch and piston
- Set of nylon roses item 1.06012.01.0
- Pre-set for additional locking points
- Threaded pivots for fixing extension bolts
- ON REQUEST:
Internal ragged extension bolts item 1.06441.00.0
Internal straight extension bolts item 1.06441.10.0
Internal extension bolts item 1.06441.20.0
Pair of external bolt connectors item 1.06442.00.0
extension bolts operated by internal rods item 1.06443.00.0
extension bolts operated by external rods item 1.06443.05.0

1	85	22	25	0,863	1	1	16225	25	0
1	85	22	30	0,908	1	1	16225	30	0
1	85	22	35	0,953	1	1	16225	35	0

Certification EN 12209:16 (For 16215 - 16225)

| 3 | X | 8 | 0 | 0 | F | 3 |

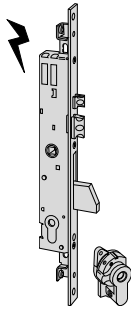

- Cross-key cylinder with 3 keys
- deadbolt and latch
- 10.5 to 16.5 mm. adjustable latch and piston
- Pre-set for additional locking points
- Set of nylon roses item 1.06002.00.0
- Threaded pivots for fixing extension bolts
- ON REQUEST:
Internal ragged extension bolts item 1.06441.00.0
Internal straight extension bolts item 1.06441.10.0
Internal extension bolts item 1.06441.20.0
External bolt connectors item 1.06442.00.0
extension bolts operated by internal rods item 1.06443.00.0
extension bolts operated by external rods item 1.06443.05.0

1	85	22	25	0,953	1	1	16227	25	0
1	85	22	30	1,014	1	1	16227	30	0
1	85	22	35	1,059	1	1	16227	35	0

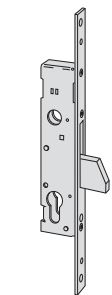

- deadbolt only
- Set of nylon roses item 1.06012.01.0
- AS ABOVE
- U-shaped faceplate 24x5 mm
- Pair of spacers 3 and 5 mm

1	22	25	0,575	12	1	46210	25	0
1	22	30	0,605	12	1	46210	30	0
1	22	35	0,560	12	1	46210	35	0

1	24	25	0,545	12	1	46213	25	0
1	24	30	0,575	12	1	46213	30	0
1	24	35	0,560	12	1	46213	35	0

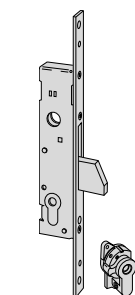

- Cross-key cylinder with 3 keys
- deadbolt only
- Set of nylon roses item 1.06002.00.0

1	22	25	0,650	12	1	46212	25	0
1	22	30	0,670	12	1	46212	30	0
1	22	35	0,690	12	1	46212	35	0

Type	Description	Throws	Centre Distance	Faceplate	Backset	Unit weight Kg	Pieces	ITEM				
								Type	Dim.	Hand	Fin.	Pers. Spec.

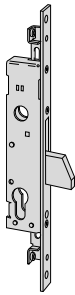

- deadbolt only
- Pre-set for additional locking points
- Set of nylon roses item 1.06012.01.0
- Threaded pivots for fixing extension bolts
- ON REQUEST:
Internal ragged extension bolts item 1.06441.00.0
Internal straight extension bolts item 1.06441.10.0
Internal extension bolts item 1.06441.20.0
External bolt connectors item 1.06442.00.0
extension bolts operated by internal rods item 1.06443.00.0
extension bolts operated by external rods item 1.06443.05.0
Internal extension rods hook side deadbolts item 1.06443.41.0
External extension rods hook side deadbolts item 1.06443.46.0

1	22	25	0,630	12	1	46220	25	0				
1	22	30	0,650	12	1	46220	30	0				
1	22	35	0,680	12	1	46220	35	0				

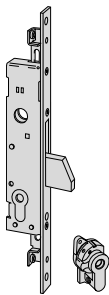

- Cross-key cylinder with 3 keys
- deadbolt only
- Pre-set for additional locking points
- Set of nylon roses item 1.06002.00.0
- Threaded pivots for fixing extension bolts
- ON REQUEST:
Internal ragged extension bolts item 1.06441.00.0
Internal straight extension bolts item 1.06441.10.0
Internal extension bolts item 1.06441.20.0
External bolt connectors item 1.06442.00.0
extension bolts operated by internal rods item 1.06443.00.0
extension bolts operated by external rods item 1.06443.05.0
Internal extension rods hook side deadbolts item 1.06443.41.0
External extension rods hook side deadbolts item 1.06443.46.0

1	22	25	0,695	12	1	46222	25	0				
1	22	30	0,690	12	1	46222	30	0				
1	22	35	0,710	12	1	46222	35	0				

Certification EN 12209:16 (for 46210 - 46213 - 46220 - 46240 - 46260 - 46270)

| 3 | C | 8 | 0 | 0 | F | 3 | H |

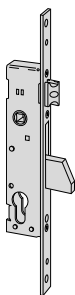

- deadbolt and latch
- 11 to 17 mm. adjustable latch
- Set of nylon roses item 1.06012.01.0
- ON REQUEST: (SERIES 46215):
Stainless steel faceplate 25x3 mm with aligned fixing holes (pers. VV)
- AS ABOVE
- U-shaped faceplate 24x5 mm
- Pair of spacers 3 and 5 mm

1	85	22	25	0,640	12	1	46215	25	0			
1	85	22	30	0,604	12	1	46215	30	0			
1	85	22	35	0,690	12	1	46215	35	0			
1	92	22	25	0,610	12	1	46219	25	0			
1	92	22	30	0,646	12	1	46219	30	0			
1	92	22	35	0,670	12	1	46219	35	0			
1	92	24	25	0,610	12	1	46218	25	0			
1	92	24	30	0,630	12	1	46218	30	0			
1	92	24	35	0,660	12	1	46218	35	0			

Type	Description	Throws	Centre Distance	Faceplate	Backset	Unit weight Kg	Pieces	ITEM			
								Type	Dim.	Hand	Fin.

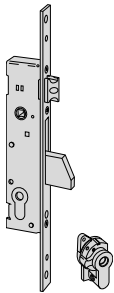

- Cross-key cylinder with 3 keys
- deadbolt and latch
- 11 to 17 mm. adjustable latch
- Set of nylon roses item 1.06002.00.0

1	85	22	25	0,730	12	1	46217	25	0
1	85	22	30	0,740	12	1	46217	30	0
1	85	22	35	0,770	12	1	46217	35	0

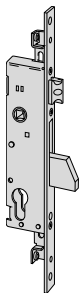

- Deadbolt and latch
- 11 to 17 mm. adjustable latch bolt
- Pre-set for additional locking points
- Set of nylon roses item 1.06012.01.0
- Threaded pivots for fixing extension bolts
- ON REQUEST:
Internal cranked extension bolts item 1.06441.00.0
Internal straight extension bolts item 1.06441.10.0
Internal extension bolts item 1.06441.20.0
External bolt connectors item 1.06442.00.0
extension bolts operated by internal rods item 1.06443.00.0
extension bolts operated by external rods item 1.06443.05.0
Internal extension rods hook side deadbolts item 1.06443.41.0
External extension rods hook side deadbolts item 1.06443.46.0
Stainless steel faceplate 25x3 mm with aligned fixing holes (pers. V V)

1	85	22	25	0,680	12	1	46225	25	0
1	85	22	30	0,725	12	1	46225	30	0
1	85	22	35	0,730	12	1	46225	35	0

Certification EN 12209:16 (for 46215 - 46218 - 46219 - 46225)

| 3 | X | 8 | 0 | 0 | F | 3 | H |

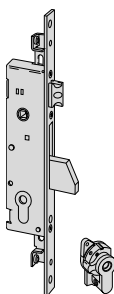

- Cross-key cylinder with 3 keys
- deadbolt and latch
- 11 to 17 mm. adjustable latch
- Pre-set for additional locking points
- Set of nylon roses item 1.06002.00.0
- Threaded pivots for fixing extension bolts
- ON REQUEST:
Internal ragged extension bolts item 1.06441.00.0
Internal straight extension bolts item 1.06441.10.0
External bolt connectors item 1.06442.00.0
extension bolts operated by internal rods item 1.06443.00.0
extension bolts operated by external rods item 1.06443.05.0
Internal extension rods hook side deadbolts item 1.06443.41.0
External extension rods hook side deadbolts item 1.06443.46.0

1	85	22	25	0,750	12	1	46227	25	0
1	85	22	30	0,790	12	1	46227	30	0
1	85	22	35	0,790	12	1	46227	35	0

Type	Description	Throws	Centre Distance	Faceplate	Backset	Unit weight 	Pieces 	ITEM				
								Type	Dim.	Hand	Fin.	Pers. Spec.

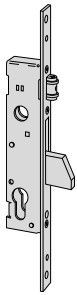

- deadbolt and roller
- 2.5 to 16.5 mm. adjustable roller
- Set of nylon roses item 1.06012.01.0
- ON REQUEST:
Stainless steel faceplate 25x3 mm with aligned fixing holes (pers. V V)
- AS ABOVE
- U-shaped faceplate 24x5 mm
- Pair of spacers 3 and 5 mm

1	22	25	0,600	12	1	46230	25	0			
1	22	30	0,640	12	1	46230	30	0			
1	22	35	0,665	12	1	46230	35	0			
1	24	25	0,600	12	1	46233	25	0			
1	24	30	0,610	12	1	46233	30	0			
1	24	35	0,635	12	1	46233	35	0			

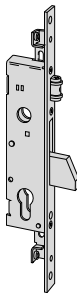

- deadbolt and roller
- 2.5 to 16.5 mm. adjustable roller
- Pre-set for additional locking points
- Set of nylon roses item 1.06012.01.0
- Threaded pivots for fixing extension bolts
- ON REQUEST:
Internal ragged extension bolts item 1.06441.00.0
Internal straight extension bolts item 1.06441.10.0
Internal extension bolts item 1.06441.20.0
External bolt connectors item 1.06442.00.0
extension bolts operated by internal rods item 1.06443.00.0
extension bolts operated by external rods item 1.06443.05.0

1	22	25	0,660	12	1	46250	25	0			
1	22	30	0,690	12	1	46250	30	0			
1	22	35	0,715	12	1	46250	35	0			

Certification EN 12209:16
(For 46230 - 46233 - 46250)

| 3 | C | 8 | 0 | 0 | F | 3 | H |

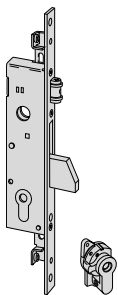

- Cross-key cylinder with 3 keys
- deadbolt and latch
- 2.5 to 16.5 mm. adjustable roller
- Pre-set for additional locking points
- Set of nylon roses item 1.06002.00.0
- Threaded pivots for fixing extension bolts
- ON REQUEST:
Internal ragged extension bolts item 1.06441.00.0
Internal straight extension bolts item 1.06441.10.0
External bolt connectors item 1.06442.00.0
extension bolts operated by internal rods item 1.06443.00.0
extension bolts operated by external rods item 1.06443.05.0

1	22	25	0,730	12	1	46252	25	0			
1	22	30	0,760	12	1	46252	30	0			
1	22	35	0,790	12	1	46252	35	0			

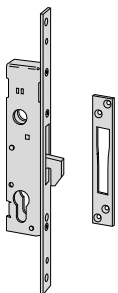

- Laminar steel hook
- Set of nylon roses item 1.06012.01.0
- Zinc plated steel strikier item 1.06459.01.0

1	22	25	0,610	12	1	46240	25	0			
1	22	30	0,640	12	1	46240	30	0			
1	22	35	0,660	12	1	46240	35	0			

Type	Description	Throws	Centre Distance	Faceplate Backset	Unit weight Kg	Pieces	ITEM			
							Type	Dim. Hand	Fin.	Pers. Spec.

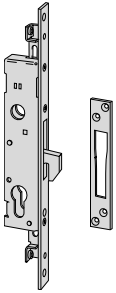

- Laminar steel hook
- Pre-set for additional locking points
- Set of nylon roses item 1.06012.01.0
- Threaded pivots for fixing extension bolts
- Zinc plated steel striker item 1.06459.01.0
- ON REQUEST:
 - Internal ragged extension bolts item 1.06441.00.0
 - Internal straight extension bolts item 1.06441.10.0
 - External bolt connectors item 1.06442.00.0
 - Internal extension rods hook side deadbolts item 1.06443.41.0
 - External extension rods hook side deadbolts item 1.06443.46.0

1	22	25	0,655	12	1	46260 25 0
1	22	30	0,650	12	1	46260 30 0
1	22	35	0,740	12	1	46260 35 0

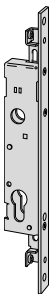

- No frontal closure
- Pre-set for additional locking points
- Set of nylon roses item 1.06012.01.0
- Threaded pivots for fixing extension bolts
- ON REQUEST:
 - Internal ragged extension bolts item 1.06441.00.0
 - Internal straight extension bolts item 1.06441.10.0
 - External bolt connectors item 1.06442.00.0
 - Internal extension rods hook side deadbolts item 1.06443.41.0
 - External extension rods hook side deadbolts item 1.06443.46.0

	22	25	0,580	12	1	46270 25 0
	22	30	0,580	12	1	46270 30 0
	22	35	0,605	12	1	46270 35 0



Technical features:

- Galvanized steel case, height 64 mm
- Stainless steel faceplate
- Nickel-plated adjustable latchbolt, 11 to 17 mm
- Nickel-plated 3-throw deadbolt, 11 mm
- Square spindle, 8 mm
- Cylinder fixing via lock internal screw

Supplied as standard:

- Threaded pins for additional lock fixing
- Pair of nylon roses item 1.06012.01.0
- Pair of below-faceplate nylon spacers item 1.06141.65.0
- Rose and lock fixing screws
- Instruction sheets

Cylinder to be ordered separately

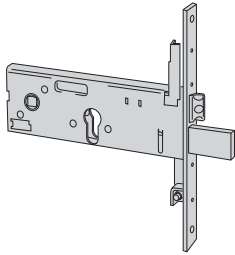

Type	Description	Throws	Centre Distance	Faceplate	Backset	Unit weight 	Pieces 	ITEM			
								Type	Dim.	Hand	Fin.

	<ul style="list-style-type: none"> • Stainless steel faceplate 32x3 mm • Reversible latch and deadbolt • ON REQUEST: Adjustable metal strikers (see vademecum) "MODULAR" roller assembly item 1.06168-00-0 Internal cranked extension bolts item 1.06441.00.0 Internal straight extension bolts item 1.06441.10.0 Pair of external bolt connectors item 1.06442.00.0 extension bolts operated by internal rods item 1.06443.00/21.0 extension bolts operated by external rods item 1.06443.05/26.0 Internal extension rods hook side deadbolts item 1.06443.41.0 External extension rods hook side deadbolts item 1.06443.46.0 Cylinder protective rose item 1.06460-05/50/51/60 Rose for locks series 57300 item 1.06141-56-0 or item 1.06473.00.0 	3	67	22	90	0,995	12	1	56357	90	0
		3	67	22	100	0,995	12	1	56357	10	0

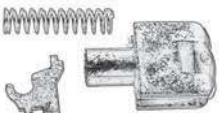
	<ul style="list-style-type: none"> • "MODULAR" roller assembly for locks series 56357 					0,040	12	1	06168	00	0
---	--	--	--	--	--	-------	----	---	-------	----	---



Technical features:

- Case height 82 mm
- Zinc-plated case
- Zinc-plated faceplate
- Nickel-plated steel deadbolt
- Nickel-plated, reversible latch and roller
- Drill resistant protection plate

- Nylon faceplate spacer
- Lock fixing screws
- Instruction sheet

On request:

- Specific striker (see Vademecum)

Hand:

0 = Non-handed

Supplied as standard:

- 3 keys item 1.00100.00.0 or item 1.00102.00.0
- Set of nylon key guide escutcheons item 1.06123.03.0
- Set of escutcheon fixing screws:
length 60 mm for the version with key item 1.00100.00.0
length 75 mm for the version with key item 1.00102.00.0

Type	Description	Key item	Throws	Centre Distance	Faceplate	Backset	Unit weight 	Pieces 	ITEM				
									Type	Dim.	Hand	Fin.	Pers.

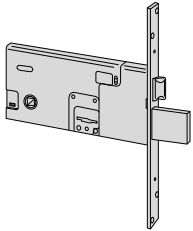

- Deadbolt and latch



4 67 25 70 1,150 12 1 57312 73 0

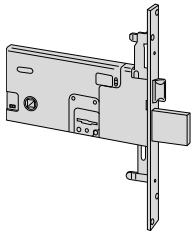

- Deadbolt and latch
- Pre-set for additional locking points
- ON REQUEST:
Internal ragged extension bolts item 1.06451.00.0
Internal straight extension bolts item 1.06451.10.0
External bolt connectors item 1.06452.05.0
extension bolts operated by internal rods item 1.06453.05.0



4 67 25 70 1,226 12 1 57317 73 0



4 67 25 70 1,230 12 1 57317 71 0

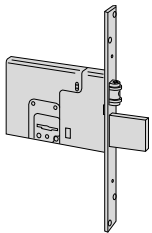

- Deadbolt and roller
- 2 to 14.5 mm. adjustable roller



4 25 70 1,025 12 1 57320 73 0

Type	Description	Key item	Throws	Centre Distance	Faceplate	Backset	Unit weight 	Pieces 	ITEM			
									Type	Dim.	Hand	Fin.
	<ul style="list-style-type: none"> • Deadbolt and roller • 2 to 14.5 mm. adjustable roller • Pre-set for additional locking points • ON REQUEST: Internal ragged extension bolts item 1.06451.00.0 Internal straight extension bolts item 1.06451.10.0 External bolt connectors item 1.06452.05.0 extension bolts operated by internal rods item 1.06453.05.0 	 1 00100 00 1	4	25	70	1,080	12	1	57325	73	0	
		 1 00102 00 1	4	25	70	1,100	12	1	57325	71	0	
	<ul style="list-style-type: none"> • Deadbolt only • Pre-set for additional locking points • ON REQUEST: Internal ragged extension bolts item 1.06451.00.0 Internal straight extension bolts item 1.06451.10.0 External bolt connectors item 1.06452.05.0 extension bolts operated by internal rods item 1.06453.05.0 	 1 00100 00 1	4	25	70	1,140	12	1	57335	73	0	



Technical features:

- Case height 78 mm
- Zinc-plated case
- Stainless steel faceplate
- Nickel-plated steel deadbolt
- Nickel-plated roller and reversible latch
- Drill resistant protection plate
- Electrical and mechanical versions are interchangeable
- Current absorption 1,7 A
- Voltage 12 V ac CE

Supplied as standard:







- 3 keys item 1.00100.00.0 or item 1.00102.00.0
- Set of nylon key guide escutcheons item 1.06123.03.0

- Rose fastening screws: length 60 mm for the version with key item 1.00100.00.0 length 75 mm for the version with key item 1.00102.00.0
- Set of nylon faceplate spacers item 1.06141.65.0
- Threaded extension bolts connectors
- Lock fixing screws
- Instruction sheet

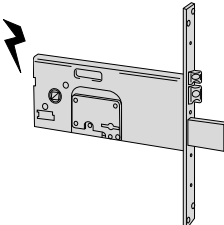
On request:

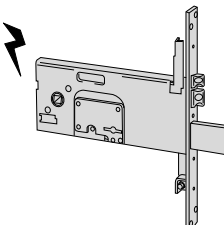
- Specific striker
- Mechanical control button item 1.06110.15.0

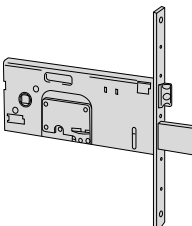
Hand:
0 = Non-handed

Type	Description	Key item	Throws	Centre Distance	Faceplate Backset	Unit weight Kg	Pieces	ITEM				
								Type	Dim.	Hand	Fin. Pers. Spec.	
	<ul style="list-style-type: none"> • Deadbolt and latch • 12 to 18 mm. adjustable latch and piston • Dead-locking latch • Hold-open latch 	 1 00100 00 1	4	67	22	90	1,330	1	1	17352	90	0
			4	67	22	100	1,385	1	1	17352	10	0
	<ul style="list-style-type: none"> • Deadbolt and latch • 12 to 18 mm. adjustable latch and piston • Dead-locking latch • Hold-open latch • Pre-set for additional locking points • Threaded pivots for fixing extension bolts • ON REQUEST: Internal ragged extension bolts item 1.06441.00.0 Internal straight extension bolts item 1.06441.10.0 External bolt connectors item 1.06442.00.0 extension bolts operated by internal rods item 1.06443.00.0 extension bolts operated by external rods item 1.06443.05.0 	 1 00100 00 1	4	67	22	90	1,400	1	1	17357	90	0
			4	67	22	100	1,463	1	1	17357	10	0
			4	67	22	90	1,410	1	1	17357	91	0
			4	67	22	100	1,450	1	1	17357	11	0
	<ul style="list-style-type: none"> • Deadbolt and latch • 11 to 17 mm. adjustable latch 	 1 00100 00 1	4	67	22	90	1,210	12	1	57352	90	0
			4	67	22	100	1,316	12	1	57352	10	0

Type	Description	Key item	Throws	Centre Distance	Faceplate	Backset	Unit weight 	Pieces 	ITEM					
									Type	Dim.	Hand	Fin.	Pers. Spec.	
	<ul style="list-style-type: none"> • Deadbolt and latch • 11 to 17 mm. adjustable latch • Pre-set for additional locking points • Threaded pivots for fixing extension bolts • ON REQUEST: Internal ragged extension bolts item 1.06441.00.0 Internal straight extension bolts item 1.06441.10.0 External bolt connectors item 1.06442.00.0 extension bolts operated by internal rods item 1.06443.00.0 extension bolts operated by external rods item 1.06443.05.0 	 1 00100 00 1	4	67	22	90	1,275	12	1	57357	90	0		
			4	67	22	100	1,340	12	1	57357	10	0		
	<ul style="list-style-type: none"> • Deadbolt and roller • 2 to 14.5 mm. adjustable roller 	 1 00102 00 1	4	67	22	90	1,305	12	1	57357	91	0		
			4	67	22	100	1,355	12	1	57357	11	0		
	<ul style="list-style-type: none"> • Deadbolt and roller • 2 to 14.5 mm. adjustable roller • Pre-set for additional locking points • Threaded pivots for fixing extension bolts • ON REQUEST: Internal ragged extension bolts item 1.06441.00.0 Internal straight extension bolts item 1.06441.10.0 External bolt connectors item 1.06442.00.0 extension bolts operated by internal rods item 1.06443.00.0 extension bolts operated by external rods item 1.06443.05.0 	 1 00100 00 1	4	22	90	1,225	12	1	57365	90	0			
			4	22	100	1,250	12	1	57365	10	0			
	<ul style="list-style-type: none"> • Deadbolt only 	 1 00100 00 1	4	22	90	1,129	12	1	57370	90	0			
			4	22	100	1,168	12	1	57370	10	0			

Type	Description	Key item	Throws	Centre Distance	Faceplate Backset	Unit weight Kg	Pieces	ITEM			
								Type	Dim.	Hand	Fin. Pers. Spec.
	<ul style="list-style-type: none"> • Deadbolt only • Pre-set for additional locking points • Threaded pivots for fixing extension bolts • ON REQUEST: <ul style="list-style-type: none"> Internal ragged extension bolts item 1.06441.00.0 Internal straight extension bolts item 1.06441.10.0 External bolt connectors item 1.06442.00.0 extension bolts operated by internal rods item 1.06443.00.0 extension bolts operated by external rods item 1.06443.05.0 	 1 00100 00 1	4	22	90	1,185	12	1	57375	90	0
			4	22	100	1,250	12	1	57375	10	0

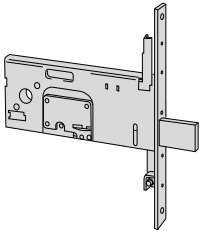

Type	Description	For series/item	Unit weight 	Pieces 	ITEM			
					Type	Dim.	Hand	Fin.
	<ul style="list-style-type: none"> • Zinc plated cranked internal extension bolts • SUPPLIED AS STANDARD: Set of 8 mm. diameter rods Hardened steel tip 8 mm. item 1.06291.06.0 (2 pcs) Floor striker item 1.06086.01.0 Joining pin item 1.06291.20.0 Guide rods item 1.06224.00.0 (2 pcs) Noise proof bushes item 1.06147.00.0 	16225, 16227, 17357, 19225, 46200, 46220, 46222, 46225, 46227, 46250, 46252, 46260, 46265, 46270, 46275, 49225, 49228, 49250, 56357, 57357, 57365, 57375, 56378	0,610	12	1	06441	00	0
	<ul style="list-style-type: none"> • Zinc plated straight internal extension bolts • SUPPLIED AS STANDARD: Set of 8 mm. diameter rods Hardened steel tip 8 mm. item 1.06291.06.0 (2 pcs) Floor striker item 1.06086.01.0 Joining pin item 1.06291.20.0 Guide rods item 1.06224.00.0 (2 pcs) Noise proof bushes item 1.06147.00.0 	16225, 16227, 17357, 19225, 46200, 46220, 46222, 46225, 46227, 46250, 46252, 46260, 46265, 46270, 49225, 49228, 49250, 57357, 57365, 57375, 56378	0,566	12	1	06441	10	0
	<ul style="list-style-type: none"> • Zinc plated straight internal extension bolts with screws • SUPPLIED AS STANDARD: Set of 8 mm. diameter rods Hardened steel tip 8 mm. item 1.06291.06.0 (2 pcs) Floor striker item 1.06086.01.0 Set of threaded bushes (M8) item 1.06290.05.0 Joining pin item 1.06291.20.0 Guide rods item 1.06224.00.0 (2 pcs) Noise proof bushes item 1.06147.00.0 	16225, 16227, 17357, 46220, 46222, 46225, 46227, 46250, 46252, 46260, 46270, 56378, 57357, 57365, 57375	0,630	12	1	06441	20	0

Type	Description	For series/item	Unit weight Pieces	ITEM				
				Type	Dim.	Hand	Fin.	Pers. Spec.
	<ul style="list-style-type: none"> • Set of controls for external extension bolts 	16225, 16227, 17357, 19225, 46200, 46220, 46222, 46225, 46227, 46250, 46252, 46260, 46275, 49225, 49228, 49250, 56357, 57357, 57365, 57375	0,020	12	1	06442	00	0
	<ul style="list-style-type: none"> • Set of lateral extension bolts operated by internal rods • Swing bolts • 22 x 3 mm. stainless steel faceplate • SUPPLIED AS STANDARD: Set of rods diameter 8 mm. Set of faceplate spacers item 1.06141.65.0 Guide rods item 1.06224.00.0 (2 pcs) • Pin connector item 1.06291.20.0 • ON REQUEST: Special striker (see Vademecum) Personalised internal extension bolts item 1.06449.00.0 	16225, 16227, 17357, 46200, 46220, 46222, 46250, 46252, 46260, 46265, 46270, 46275, 56357, 57357, 57365, 57375, 56378	0,854	1	1	06443	00	0
	<ul style="list-style-type: none"> • Set of lateral extension bolts operated by external rods • Swing bolts • 22 x 3 mm. stainless steel faceplate • SUPPLIED AS STANDARD: set of external bolt connectors Set of threaded rods • ON REQUEST: Special striker (see Vademecum) 	16225, 16227, 17357, 46200, 46220, 46222, 46225, 46227, 46250, 46252, 46260, 46265, 46270, 46275, 56357, 57357, 57365, 57375, 56378	0,513	1	1	06443	05	0

Type	Description	For series/item	Unit weight Kg	Pieces	ITEM			
					Type	Dim.	Hand	Fin.

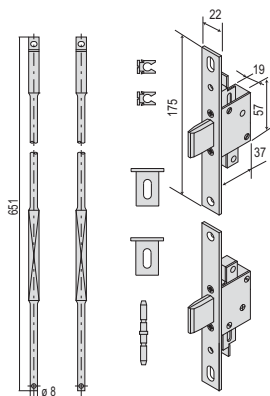

- Pair of lateral extension bolts operated by internal rods
- Horizontally sliding deadbolts with hardened steel inserts and hook bolt
- STAINLESS STEEL faceplate 22x3 mm
- Pre-set for 4th and 5th locking points
- SUPPLIED AS STANDARD:
 - Set of rods dia. 8 mm.
 - Set of faceplate spacers item 1.06141.65.0
 - Rod guide item 1.06224.00.0 (2 pcs)
 - Joining pin item 1.06291.20.0
- ON REQUEST:
 - Special strike plates (see Vademecum)
 - Internal straight extension bolts item 1.06441.10.0 for 4th and 5th locking points
 - Threaded pin for bolt extension rods fixing item 1.06449.05.0
 - Custom internal bolt extension rods item 1.06449.00.0

56357, 56378 1,060 1 1 06443 21 0

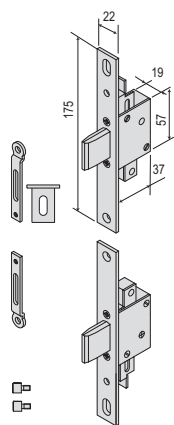

- Pair of lateral extension bolts operated by external rods
- Horizontally sliding deadbolts with hardened steel inserts and hook bolt
- STAINLESS STEEL faceplate 22x3 mm
- Pre-set for 4th and 5th locking points
- SUPPLIED AS STANDARD:
 - Set of external bolt connectors
 - Set of threaded pins
- ON REQUEST:
 - Special strike plates (see Vademecum)
 - Threaded pin item 1.06449.05.0 for fixing 4th and 5th locking point external extension bolts

56357, 56378 0,766 1 1 06443 26 0

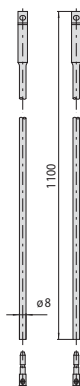

- Internal extension bolts for personalising lateral locking point distance
- SUPPLIED AS STANDARD:
 - Set of rods diameter 8 mm.
 - Set of pins for fixing rods to lateral extension bolts

1 06443 00 0, 0,495 12 1 06449 00 0
 1 06443 21 0,
 1 06443 31 0,
 1 06443 41 0

Type	Description	For series/item	Unit weight Pieces	ITEM				
				Type	Dim.	Hand	Fin.	Pers. Spec.
	<ul style="list-style-type: none"> • Zinc-plated cranked internal extension bolts • SUPPLIED AS STANDARD: Set of 8 mm diameter bolts Set of 8 mm diameter tips item 1.06291.06.0 (2 pcs) Floor striker item 1.06086.01.0 Joining pin item 1.06291.20.0 Set of rod guide clips item 1.06224.00.0 (2 pcs) Noise-proof bushings item 1.06147.00.0 	57317, 57325, 57335	0,620	12	1	06451	00	0
	<ul style="list-style-type: none"> • Zinc plated internal straight extension bolts • SUPPLIED AS STANDARD: Set of rods diameter 8 mm. Hardened steel tip diameter 8 mm. item 1.06291.06.0 (2 pcs) Floor striker item 1.06086.01.0 Joining pin item 1.06291.20.0 Guide rods item 1.06224.00.0 (2 pcs) Noise proof bushes item 1.06147.00.0 	57317, 57325, 57335	0,575	12	1	06451	10	0
	<ul style="list-style-type: none"> • Set of controls for external extension bolts 	57317, 57325, 57335	0,034	12	1	06452	05	0
	<ul style="list-style-type: none"> • Set of lateral extension bolts operated by internal rods • Swing bolts • 25 x 3 mm. stainless steel faceplate • SUPPLIED AS STANDARD: Set of rods diameter 8 mm. Guide rods item 1.06224.00.0 (2 pcs) • ON REQUEST: Special striker (see Vademecum) Personalised internal rod extension bolts item 1.06419.10.0 	57317, 57325, 57335	0,865	1	1	06453	05	0

Type	Description	For series/item	Unit weight 	Pieces 	ITEM			
					Type	Dim.	Hand	Fin.

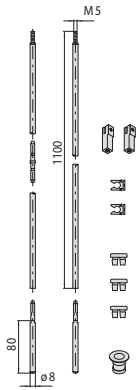

- Set of zinc plated internal extension bolts with screws
- SUPPLIED AS STANDARD:
 - Set of rods diameter 8 mm.
 - Hardened steel tip diameter 8 mm.
 - item 1.06291.06.0 (2 pcs)
 - Floor striker item 1.06086.01.0
 - Joining pin item 1.06291.20.0
 - Guide rods item 1.06224.00.0 (2 pcs)
 - Noise proof bushes item 1.06147.00.0
 - Set of threaded bushes item 1.06290.00.0

57317, 57325, 57335, 0,604 12 1 07088 00 0



Technical features:

- Zinc-plated closed case
- High resistance zinc-plated or stainless steel faceplate (fin.20)
- Nickel-plated roller, latchbolt and deadbolt
- 10 to 15 mm adjustable reversible latchbolt
- 2.5 to 14 mm adjustable roller
- 9.5 mm thick steel deadbolt
- Case enclosed to stop dirt and dust entering

Supplied as standard:

- Cylinder fixing screws

On request:

- Euro profile cylinder
- Special strikers (see Vademecum)

Standards:

- This lock series is fully tested to 12209:2016
- Grade 3 - Category of use (For use by the public where there is little incentive to exercise care and where there is a high chance of misuse, e.g. doors in public buildings) 3 S 7 0 0 F 2 0

Hand:
0 = Non-handed

Cylinder to be ordered separately



Type	Description	Throws	Centre Distance	Faceplate	Backset	Unit weight Kg	Pieces	ITEM				
								Type	Dim.	Hand	Fin.	Pers.



REPLACES 44650 SERIES

- 10 to 15 mm adjustable latchbolt only (20 mm backset adjustable 11 to 14 mm)
- Zinc-plated faceplate

1	22	21	0,355	12	1	44651 20 0
1	22	25	0,373	12	1	44651 25 0
1	22	30	0,390	12	1	44651 30 0
1	22	35	0,425	12	1	44651 35 0

- 10 to 15 mm adjustable latchbolt only (20 mm backset adjustable 11 to 14 mm)
- Stainless steel faceplate

1	22	21	0,355	12	1	44651 20 0 20
1	22	25	0,373	12	1	44651 25 0 20
1	22	30	0,390	12	1	44651 30 0 20
1	22	35	0,425	12	1	44651 35 0 20

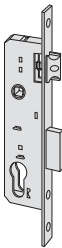

REPLACES 44660 SERIES

- Deadbolt and 10 to 15 mm adjustable latchbolt (20 mm backset adjustable 11 to 14 mm)
- Zinc-plated faceplate

1	85	22	20	0,407	12	1 44661 20 0
1	85	22	25	0,431	12	1 44661 25 0
1	85	22	30	0,470	12	1 44661 30 0
1	85	22	35	0,505	12	1 44661 35 0

- Deadbolt and 10 to 15 mm adjustable latchbolt (20 mm backset adjustable 11 to 14 mm)
- Stainless steel faceplate

1	85	22	20	0,407	12	1 44661 20 0 20
1	85	22	25	0,431	12	1 44661 25 0 20
1	85	22	30	0,470	12	1 44661 30 0 20
1	85	22	35	0,505	12	1 44661 35 0 20



REPLACES 44665 SERIES

- Deadbolt and 10 to 15 mm adjustable latchbolt (20 mm backset adjustable 11 to 14 mm)
- Zinc-plated faceplate

2	85	22	20	0,420	12	1 44666 20 0
2	85	22	25	0,446	12	1 44666 25 0
2	85	22	30	0,486	12	1 44666 30 0
2	85	22	35	0,518	12	1 44666 35 0

Type	Description	Throws	Centre Distance	Faceplate	Backset	Unit weight Kg	Pieces	ITEM			
								Type	Dim.	Hand	Fin.
	<p>REPLACES 44670 SERIES</p> <ul style="list-style-type: none"> • Deadbolt and 2.5 to 14 mm adjustable roller • Zinc-plated faceplate 	1	22	20	0,368	12	1	44671	20	0	
		1	22	25	0,400	12	1	44671	25	0	
		1	22	30	0,450	12	1	44671	30	0	
		1	22	35	0,463	12	1	44671	35	0	
	<ul style="list-style-type: none"> • Deadbolt and 2.5 to 14 mm adjustable roller • Stainless steelfaceplate 	1	22	20	0,368	12	1	44671	20	0	20
		1	22	21	0,400	12	1	44671	25	0	20
		1	22	30	0,450	12	1	44671	30	0	20
		1	22	35	0,463	12	1	44671	35	0	20
	<p>REPLACES 44680 SERIES</p> <ul style="list-style-type: none"> • Deadbolt only • Zinc-plated faceplate 	1	22	20	0,334	12	1	44681	20	0	
		1	22	25	0,357	12	1	44681	25	0	
		1	22	30	0,396	12	1	44681	30	0	
		1	22	35	0,435	12	1	44681	35	0	
	<ul style="list-style-type: none"> • Deadbolt and 2.5 to 14 mm adjustable roller • Stainless steelfaceplate 	1	22	20	0,334	12	1	44681	20	0	20
		1	22	25	0,357	12	1	44681	25	0	20
		1	22	30	0,396	12	1	44681	30	0	20
		1	22	35	0,435	12	1	44681	35	0	20
	<ul style="list-style-type: none"> • Zinc-plated steel faceplate • Laminated steel hook bolt • Zinc-plated steel flat strike plate item.1.07028.00.0 	1	20	30	0,315	1	1	45110	30	0	
		1	20	35	0,325	1	1	45110	35	0	
		1	20	40	0,330	1	1	45110	40	0	
		1	20	45	0,365	1	1	45110	45	0	
		1	20	50	0,370	1	1	45110	50	0	
		1	20	60	0,405	1	1	45110	60	0	
			<ul style="list-style-type: none"> • Brass faceplate • Laminated steel hook bolt • Brass flat strike plate item 1.07028.10.0 • ON REQUEST: Fin. 12 (nickel-plated) 	1	20	30	0,315	1	1	45100	30
1	20			35	0,325	1	1	45100	35	0	
1	20			40	0,330	1	1	45100	40	0	
1	20			45	0,365	1	1	45100	45	0	
1	20			50	0,370	1	1	45100	50	0	
1	20			60	0,405	1	1	45100	60	0	



Technical features:

- Zinc-plated case
- Zinc-plated faceplate
- Brass latch, roller and bolt
- Current absorption 1,4 A
- Voltage 12 V ac CE

Hand:

0 = Non-handed

1 = R.H. inwards

2 = L.H. inwards

Supplied as standard:

- Cylinder fixing screws
- Instruction sheet (if this is provided for)

Cylinder to be ordered separately





On request:

- Specific striker (see Vademecum)

Type	Description	Throws	Centre Distance	Faceplate Backset	Unit weight Kg	Pieces	ITEM				
							Type	Dim.	Hand	Fin.	Pers. Spec.
	• Dead-locking latch	16	15	0,360	1	1	14020	15	1		
		16	15	0,355	1	1	14020	15	2		
		16	18	0,371	1	1	14020	18	1		
		16	18	0,365	1	1	14020	18	2		
	• Dead-locking latch	20	15	0,381	1	1	14021	15	1		
		20	15	0,381	1	1	14021	15	2		
		20	18	0,394	1	1	14021	18	1		
		20	18	0,394	1	1	14021	18	2		
	• Nickel-plated faceplate • Nickel-plated deadbolt only • Nickel-plated steel flat striker item 1.07027.00.0	1	20	16	0,265	1	1	44210	16	0	
	• Case height 85 mm. • Cylinder activated non-handed latch	16	15	0,140	1	1	44217	15	0		
	• Case height 85 mm. • Cylinder activated non-handed latch	20	15	0,150	1	1	44218	15	0		

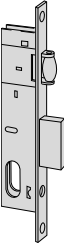
Type	Description	Throws	Centre Distance	Faceplate	Backset	Unit weight 	Pieces 	ITEM						
								Type	Dim.	Hand	Fin.	Pers. Spec.		
	<ul style="list-style-type: none"> • 4.5 mm. extra protruding deadbolt and non-handed latch • Latch can be activated by key 	1	69	14	25	0,365	1	1	44219	25	0			
		1	69	14	30	0,410	1	1	44219	30	0			
	<ul style="list-style-type: none"> • deadbolt and non-handed latch • Latch can be activated by key except for locks with E=15 and 18 	1	69	16	15	0,290	1	1	44220	15	0			
		1	69	16	18	0,310	1	1	44220	18	0			
		1	69	16	25	0,350	1	1	44220	25	0			
		1	69	16	30	0,390	1	1	44220	30	0			
		1	69	16	35	0,425	1	1	44220	35	0			
	<ul style="list-style-type: none"> • deadbolt and non-handed latch • Latch can be activated by key 	1	69	14	35	0,450	1	1	44220	35	0	00	EN	
	<ul style="list-style-type: none"> • deadbolt and non-handed latch • Latch can be activated by key except for locks with E=15 and 18 	1	69	20	15	0,305	1	1	44221	15	0			
		1	69	20	18	0,328	1	1	44221	18	0			
		1	69	20	25	0,360	1	1	44221	25	0			
		1	69	20	30	0,405	1	1	44221	30	0			
		1	69	20	35	0,430	1	1	44221	35	0			
		<ul style="list-style-type: none"> • 4.5 mm. extra protruding deadbolt and non-handed latch • Latch can be activated by key except for locks with E=25 	2	69	14	25	0,390	1	1	44224	25	0		
2			69	14	30	0,434	1	1	44224	30	0			
<ul style="list-style-type: none"> • deadbolt and non-handed latch • Latch can be activated by key except for locks with E=15-18-25 		2	69	16	15	0,318	1	1	44225	15	0			
		2	69	16	18	0,335	1	1	44225	18	0			
		2	69	16	25	0,374	1	1	44225	25	0			
		2	69	16	30	0,416	1	1	44225	30	0			
		2	69	16	35	0,454	1	1	44225	35	0			
<ul style="list-style-type: none"> • ABITHAL PROFILE ROUND VERSION • deadbolt and non-handed latch • Latch can be activated by key 		2	69	14	35	0,450	1	1	44225	35	0	00	EN	
<ul style="list-style-type: none"> • deadbolt and non-handed latch • Latch can be activated by key except for locks with E=15-18-25 		2	69	20	15	0,336	1	1	44226	15	0			
		2	69	20	18	0,355	1	1	44226	18	0			
		2	69	20	25	0,385	1	1	44226	25	0			
		2	69	20	30	0,433	1	1	44226	30	0			
		2	69	20	35	0,465	1	1	44226	35	0			
		<ul style="list-style-type: none"> • Case height 85 mm. • Handle activated non-handed latch 				16	15	0,170	1	1	44227	15	0	
	<ul style="list-style-type: none"> • Case height 85 mm. • Handle activated non-handed latch 				20	15	0,180	1	1	44228	15	0		
	<ul style="list-style-type: none"> • Adjustable deadbolt and roller 	1	16	15	0,265	1	1	44230	15	0				
		1	16	18	0,292	1	1	44230	18	0				
		1	16	25	0,340	1	1	44230	25	0				
		1	16	30	0,375	1	1	44230	30	0				
		1	16	35	0,408	1	1	44230	35	0				
	<ul style="list-style-type: none"> • Adjustable deadbolt and roller 	1	20	15	0,293	1	1	44231	15	0				
		1	20	18	0,313	1	1	44231	18	0				
		1	20	25	0,359	1	1	44231	25	0				
		1	20	30	0,391	1	1	44231	30	0				
		1	20	35	0,426	1	1	44231	35	0				

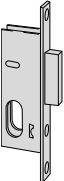
Type	Description	Throws	Centre Distance	Faceplate Backset	Unit weight Kg	Pieces	ITEM				
							Type	Dim. Hand	Fin.	Pers. Spec.	
	<ul style="list-style-type: none"> Adjustable deadbolt and roller 	2	16	15	0,300	1	1	44235	15	0	
		2	16	18	0,320	1	1	44235	18	0	
		2	16	25	0,366	1	1	44235	25	0	
		2	16	30	0,398	1	1	44235	30	0	
		2	16	35	0,434	1	1	44235	35	0	
	<ul style="list-style-type: none"> Adjustable deadbolt and roller 	2	20	18	0,340	1	1	44236	18	0	
		2	20	25	0,415	1	1	44236	25	0	
		2	20	30	0,419	1	1	44236	30	0	
		2	20	35	0,454	1	1	44236	35	0	
			<ul style="list-style-type: none"> Case height 70 mm. Adjustable roller 	16	15	0,135	1	1	44237	15	0
20	15			0,145	1	1	44238	15	0		
	<ul style="list-style-type: none"> deadbolt only 		1	16	15	0,180	1	1	44240	15	0
			1	16	18	0,199	1	1	44240	18	0
		1	16	25	0,234	1	1	44240	25	0	
		1	16	30	0,261	1	1	44240	30	0	
		1	16	35	0,290	1	1	44240	35	0	
	<ul style="list-style-type: none"> deadbolt only 	1	20	15	0,195	1	1	44241	15	0	
		1	20	18	0,211	1	1	44241	18	0	
		1	20	25	0,246	1	1	44241	25	0	
		1	20	30	0,273	1	1	44241	30	0	
		1	20	35	0,300	1	1	44241	35	0	

Type	Description	Throws	Centre Distance	Faceplate	Backset	Unit weight 	Pieces 	ITEM			
								Type	Dim.	Hand	Fin.
	• deadbolt only	2	16	15	0,210	1	1	44245	15	0	
		2	16	18	0,225	1	1	44245	18	0	
		2	16	25	0,256	1	1	44245	25	0	
		2	16	30	0,286	1	1	44245	30	0	
		2	16	35	0,315	1	1	44245	35	0	
	• deadbolt only	2	20	15	0,220	1	1	44246	15	0	
		2	20	18	0,239	1	1	44246	18	0	
		2	20	25	0,274	1	1	44246	25	0	
		2	20	30	0,300	1	1	44246	30	0	
		2	20	35	0,329	1	1	44246	35	0	
	• Nickel-plated laminar steel • Zinc plated steel flat striker item 1.07028.00.0	1	20	16	0,255	1	1	45010	16	0	
	• Nickel-plated laminated steel hook with throw • Nickel-plated steel guide pin • Zinc plated steel flat striker item 1.07028.05.0	1	20	16	0,260	1	1	45012	16	0	
	• Nickel-plated laminated steel hook with latch bolt • Dead locking latch • Nickel-plated steel guide pin • Zinc plated steel flat striker item 1.07028.05.0	1	20	16	0,260	1	1	45027	16	0	



Technical features:

- Zinc-plated case
- Zinc-plated faceplate
- Brass latch, roller and deadbolt
- Latch or reversible latch/bolt (where this is provided for)
- Electrical and mechanical versions are interchangeable
- Current absorption 3,1 A
- Voltage 12 V ac

Supplied as standard:

- Cylinder fixing screws
- Instruction sheet

On request:

- Specific striker (see Vademecum)
- Mechanical control button item 1.06110.10.0 (electrical versions)

Hand:

0 = Non-handed

Cylinder to be ordered separately



Type	Description	Throws	Centre Distance	Faceplate	Backset	Unit weight Kg	Pieces	ITEM				
								Type	Dim.	Hand	Fin.	Pers. Spec.
	<ul style="list-style-type: none"> • Case height 77 mm. • Dead-locking latch only • Hold-open latch 	67	16	70	0,560	1	1	14350	70	0		
		67	16	80	0,595	1	1	14350	80	0		
		67	16	90	0,627	1	1	14350	90	0		
	<ul style="list-style-type: none"> • Case height 77 mm. • Dead-locking latch only • Hold-open latch 	67	20	70	0,580	1	1	14351	70	0		
		67	20	80	0,633	1	1	14351	80	0		
		67	20	90	0,643	1	1	14351	90	0		
	<ul style="list-style-type: none"> • Case height 77 mm. • Dead-locking latch only • Hold-open latch • 4.5 mm. extra protruding latch and pin 	67	14,7	70	0,576	1	1	14352	70	0		
		67	14,7	80	0,608	1	1	14352	80	0		
		<ul style="list-style-type: none"> • Case height 77 mm. • Dead-locking latch only • Hold-open latch 	67	16	70	0,562	1	1	14450	70	0	
67			16	80	0,594	1	1	14450	80	0		
67			16	90	0,629	1	1	14450	90	0		
<ul style="list-style-type: none"> • Case height 77 mm. • Dead-locking latch only • Hold-open latch 		67	20	70	0,580	1	1	14451	70	0		
		67	20	80	0,608	1	1	14451	80	0		
		67	20	90	0,645	1	1	14451	90	0		
<ul style="list-style-type: none"> • Case height 77 mm. • Dead-locking latch only • Hold-open latch • 4.5 mm. extra protruding latch and pin 		67	14,7	70	0,577	1	1	14452	70	0		
		67	14,7	80	0,609	1	1	14452	80	0		
		<ul style="list-style-type: none"> • Case height 77 mm. • Dead-locking latch and deadbolt 	2	67	16	70	0,612	1	1	14460	70	0
	2		67	16	80	0,656	1	1	14460	80	0	
	2		67	16	90	0,709	1	1	14460	90	0	
	<ul style="list-style-type: none"> • Case height 77 mm. • Dead-locking latch and deadbolt 	2	67	20	70	0,627	1	1	14461	70	0	
		2	67	20	80	0,665	1	1	14461	80	0	
		2	67	20	90	0,722	1	1	14461	90	0	
	<ul style="list-style-type: none"> • Case height 77 mm. • Dead-locking latch and deadbolt • 4.5 mm. extra protruding latch, pin and deadbolt 	2	67	14,7	70	0,624	1	1	14462	70	0	
		2	67	14,7	80	0,670	1	1	14462	80	0	
			2	67	14,7	90	0,721	1	1	14462	90	0

Type	Description	Throws	Centre Distance	Faceplate	Backset	Unit weight Kg	Pieces	ITEM				
								Type	Dim.	Hand	Fin.	Pers. Spec.
	<ul style="list-style-type: none"> • Case height 64 mm. • Dead-locking latch only • Hold-open latch 	67	16	70	0,547	1	1	14510	70	0		
		67	16	80	0,580	1	1	14510	80	0		
		67	16	90	0,600	1	1	14510	90	0		
	<ul style="list-style-type: none"> • Case height 64 mm. • Dead-locking latch only • Hold-open latch 	67	20	70	0,564	1	1	14511	70	0		
		67	20	80	0,580	1	1	14511	80	0		
		67	20	90	0,600	1	1	14511	90	0		
	<ul style="list-style-type: none"> • Case height 64 mm. • Dead-locking latch only • Hold-open latch • 4.5 mm. extra protruding latch and pin 	67	14,7	70	0,554	1	1	14512	70	0		
		67	14,7	80	0,580	1	1	14512	80	0		
		67	14,7	90	0,600	1	1	14512	90	0		
		<ul style="list-style-type: none"> • Case height 44 mm. • Latch with incorporated deadbolt 	1	67	16	60	0,400	12	1	44150	60	0
			2	67	16	70	0,415	12	1	44150	70	0
			2	67	16	80	0,445	12	1	44150	80	0
2			67	16	90	0,470	12	1	44150	90	0	
<ul style="list-style-type: none"> • Case height 44 mm. • Latch with incorporated deadbolt 		1	67	20	60	0,423	12	1	44151	60	0	
		2	67	20	70	0,445	12	1	44151	70	0	
		2	67	20	80	0,460	12	1	44151	80	0	
		2	67	20	90	0,490	12	1	44151	90	0	
<ul style="list-style-type: none"> • Case height 44 mm. • 4.5 mm. extra protruding latch with incorporated deadbolt 		2	67	14,7	70	0,438	12	1	44152	70	0	
		2	67	14,7	80	0,455	12	1	44152	80	0	
		2	67	14,7	90	0,475	12	1	44152	90	0	
			<ul style="list-style-type: none"> • Case height 64 mm. • Latch with incorporated deadbolt 	1	67	16	60	0,521	12	1	44155	60
2	67			16	70	0,550	12	1	44155	70	0	
2	67			16	80	0,570	12	1	44155	80	0	
2	67			16	90	0,590	12	1	44155	90	0	
<ul style="list-style-type: none"> • Case height 64 mm. • Latch with incorporated deadbolt 	1		67	20	60	0,531	12	1	44156	60	0	
	2		67	20	70	0,576	12	1	44156	70	0	
	2		67	20	80	0,590	12	1	44156	80	0	
	2		67	20	90	0,610	12	1	44156	90	0	
	<ul style="list-style-type: none"> • Case height 44 mm. • Adjustable roller with incorporated deadbolt 		1	16	60	0,384	12	1	44160	60	0	
			2	16	70	0,413	12	1	44160	70	0	
			2	16	80	0,450	12	1	44160	80	0	
			2	16	90	0,470	12	1	44160	90	0	
	<ul style="list-style-type: none"> • Case height 44 mm. • Adjustable roller with incorporated deadbolt 	1	20	60	0,404	12	1	44161	60	0		
		2	20	70	0,420	12	1	44161	70	0		
		2	20	80	0,450	12	1	44161	80	0		
		2	20	90	0,470	12	1	44161	90	0		
		<ul style="list-style-type: none"> • Case height 77 mm. • deadbolt only 	2	16	70	0,521	1	1	44350	70	0	
			2	20	70	0,529	1	1	44351	70	0	

Type	Description	Throws	Centre Distance	Faceplate	Backset	Unit weight Kg	Pieces	ITEM				
								Type	Dim.	Hand	Fin.	Pers. Spec.
	<ul style="list-style-type: none"> • Case height 77 mm. • deadbolt only 	2	16	70	0,516	1	1	44450	70	0		
		2	20	70	0,533	1	1	44451	70	0		
	<ul style="list-style-type: none"> • Case height 77 mm. • deadbolt and latch • Latch bolt is withdrawn by the handle 	2	67	16	70	0,590	1	1	44360	70	0	
		2	67	16	80	0,598	1	1	44360	80	0	
		2	67	16	90	0,621	1	1	44360	90	0	
	<ul style="list-style-type: none"> • Case height 77 mm. • deadbolt and latch • Latch bolt is withdrawn by the handle 	2	67	20	70	0,585	1	1	44361	70	0	
		2	67	20	80	0,609	1	1	44361	80	0	
		2	67	20	90	0,641	1	1	44361	90	0	
	<ul style="list-style-type: none"> • Case height 77 mm. • 4.5 mm. extra protruding deadbolt and latch • Latch bolt is withdrawn by the handle 	2	67	14,7	70	0,582	1	1	44362	70	0	
		2	67	14,7	80	0,613	1	1	44362	80	0	
		2	67	14,7	90	0,642	1	1	44362	90	0	
	<ul style="list-style-type: none"> • Case height 77 mm. • deadbolt and latch 	2	67	16	70	0,568	1	1	44460	70	0	
		2	67	16	80	0,590	1	1	44460	80	0	
		2	67	16	90	0,628	1	1	44460	90	0	
	<ul style="list-style-type: none"> • Case height 77 mm. • deadbolt and latch 	2	67	20	70	0,583	1	1	44461	70	0	
		2	67	20	80	0,611	1	1	44461	80	0	
		2	67	20	90	0,630	1	1	44461	90	0	
	<ul style="list-style-type: none"> • Case height 77 mm. • 4.5 mm. extra protruding deadbolt and latch 	2	67	14,7	70	0,587	1	1	44462	70	0	
		2	67	14,7	80	0,605	1	1	44462	80	0	
		2	67	14,7	90	0,639	1	1	44462	90	0	
	<ul style="list-style-type: none"> • Case height 77 mm. • Adjustable deadbolt and roller 	2	16	70	0,576	1	1	44370	70	0		
		2	16	80	0,579	1	1	44370	80	0		
		2	16	90	0,610	1	1	44370	90	0		
	<ul style="list-style-type: none"> • Case height 77 mm. • Adjustable deadbolt and roller 	2	20	70	0,568	1	1	44371	70	0		
		2	20	80	0,590	1	1	44371	80	0		
		2	20	90	0,624	1	1	44371	90	0		
	<ul style="list-style-type: none"> • Case height 77 mm. • Adjustable deadbolt and roller 	2	16	70	0,542	1	1	44470	70	0		
		2	16	80	0,583	1	1	44470	80	0		
		2	16	90	0,607	1	1	44470	90	0		
	<ul style="list-style-type: none"> • Case height 77 mm. • Adjustable deadbolt and roller 	2	20	70	0,559	1	1	44471	70	0		
		2	20	80	0,601	1	1	44471	80	0		
		2	20	90	0,620	1	1	44471	90	0		



Technical features:

- Case height 82 mm
- Zinc-plated case
- Zinc-plated faceplate
- Brass latch, roller and bolt
- Electrical versions are interchangeable with item 44115/6 and item 44145/6
- Current absorption 1,3 A
- Voltage 12 V ac

Hand:

0 = Non-handed

1 = R.H. inwards

2 = L.H. inwards

Cylinder to be ordered separately



Supplied as standard:

- Cylinder fixing screws
- Instruction sheet (if this is provided for)

On request:

- Specific striker (see Vademecum)
- Mechanical control button item 1.06110.10.0

Type	Description	Throws	Centre Distance	Faceplate	Backset	Unit weight 	Pieces 	ITEM					
								Type	Dim.	Hand	Fin.	Pers.	Spec.
	• Dead-locking latch	48	16	58	0,530	12	1	14010	60	1			
		48	16	58	0,530	12	1	14010	60	2			
		48	20	58	0,550	12	1	14011	60	1			
		48	20	58	0,565	12	1	14011	60	2			
	• Dead-locking latch • Hold-open latch	48	16	58	0,556	12	1	14012	60	1			
		48	16	58	0,556	12	1	14012	60	2			
	• Dead-locking latch • Low impact piston spring • Hold-open latch	48	16	58	0,557	12	1	14017	60	1			
		48	16	58	0,557	12	1	14017	60	2			
		• Deadbolt only	2	16	58	0,485	12	1	44110	60	0		
			2	20	58	0,485	12	1	44111	60	0		
		• Deadbolt only • Interchangeable with 14010 series	2	16	58	0,475	12	1	44115	60	0		
			2	20	58	0,485	12	1	44116	60	0		
	• Deadbolt and non-handed latch	2	48	16	58	0,553	12	1	44120	60	0		
		2	48	20	58	0,570	12	1	44121	60	0		

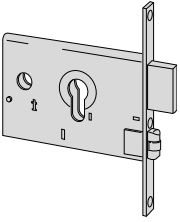
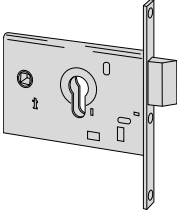
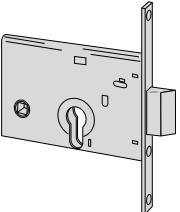
Type	Description	Throws	Centre Distance	Faceplate Backset	Unit weight Kg	Pieces	ITEM				
							Type	Dim.	Hand	Fin.	Pers. Spec.
 <ul style="list-style-type: none"> • Deadbolt and adjustable roller 		2	16	58	0,517	12	1	44130	60	0	
		2	20	58	0,530	12	1	44131	60	0	
 <ul style="list-style-type: none"> • Non-handed latch-bolt • Latch-bolt with incorporated deadbolt 		1	48	16	58	0,500	12	1	44140	60	0
		1	48	20	58	0,510	12	1	44141	60	0
 <ul style="list-style-type: none"> • Non-handed latch-bolt • Latch-bolt with incorporated deadbolt • Interchangeable with series 14010 		1	48	16	58	0,500	12	1	44145	60	0
		1	48	20	58	0,515	12	1	44146	60	0

Technical features:

- Rated voltage 12-24V ac and 12-24V dc
- Long lipped ZAL stainless alloy casing
- Steel or stainless steel interchangeable faceplates

Supplied as standard:

- Faceplate fixing screws
- Faceplate spacer (series 05020, 05021, 05005.00.0.20)

On request:

- Booster module item 1.07022.00.0

Hand:
0 = Non-handed

1 = R.H. inwards

L.H. outwards

2 = L.H. inwards

R.H. outwards

Type	Description	Faceplate	Unit weight 	Pieces 	ITEM				
					Type	Dim.	Hand	Fin.	Pers. Spec.

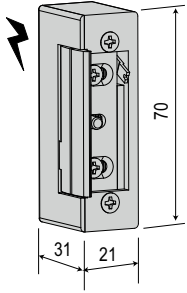

- Electric striker casing
- Voltage 12V ac - Current absorption 0,7 A
- Hold open catch mechanism
- Hold open device

- Electric striker casing
- Voltage 12V ac - Current absorption 0,7A
- Hold open catch mechanism

- Electric striker casing
- Voltage 12V ac/dc - Current absorption 0,7A
- Hold open device

- Electric striker casing
- Voltage 12V ac/dc - Current absorption 0,7A

- Electric striker casing
- Voltage 24V ac - Current absorption 0,4A
- Hold open catch mechanism
- Hold open device

- Electric striker casing
- Voltage 24V ac - Current absorption 0,4A
- Hold open catch mechanism

- Electric striker casing
- Voltage 24V ac/dc - Current absorption 0,4A
- Hold open device

- Electric striker casing
- Voltage 24V ac/dc - Current absorption 0,4A

- Electric striker casing
- Live coils: opening is only obtained if power supply is cut
- Voltage 12V dc - Current absorption 0,20A

- Electric striker casing
- Live coils: opening is only obtained if power supply is cut
- Voltage 24V dc - Current absorption 0,12A

0,185	12	1	15100 00 0	
0,185	12	1	15101 00 0	
0,170	12	1	15102 00 0	
0,185	12	1	15110 00 0	
0,185	12	1	15120 00 0	
0,185	12	1	15121 00 0	
0,185	12	1	15122 00 0	
0,185	12	1	15130 00 0	
0,185	12	1	15140 00 0	
0,185	12	1	15150 00 0	

Type	Description	Faceplate	Unit weight Kg	Pieces	ITEM				
					Type	Dim.	Hand	Fin.	Pers.
	<ul style="list-style-type: none"> • Electric striker casing • Voltage 12V ac - Current absorption 0,7A • Inside hold open catch mechanism • Hold open device 		0,185	12	1	15160	00	0	
	<ul style="list-style-type: none"> • Electric striker casing • Voltage 12V dc - Current absorption 0,25A 		0,185	12	1	15170	00	0	

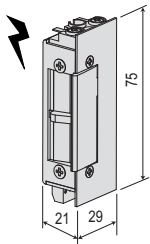

- Electric strike body
- 1 microswitch for latch position
- Adjustable long lip
- Voltage 10/24V AC/DC
- Absorbed current 0.24 A at 10 V DC

0,280 12 1 15200 00 0

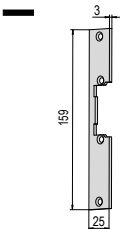

- Square corner steel flat faceplate compatible with latch only locks
- FINISHES
 - gold fin. 06
 - silver fin. 07
 - nickel-plated fin. 12
 - brass lacquered fin. 38
 - satin-finished stainless steel fin. 20

25 0,070 6 1 05005 00 0 06
 25 0,070 6 1 05005 00 0 07
 25 0,070 6 1 05005 00 0 12
 25 0,070 6 1 05005 00 0 20
 25 0,070 6 1 05005 00 0 38

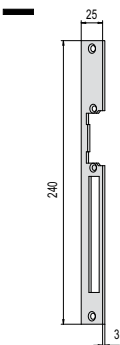

- Square corner steel flat faceplate
- For use with latch locks 44600, 46000, 49000, 57300 series
- SUPPLIED AS STANDARD
 spacer of nylon item 1.06141.84.0 (2 pair 3mm)

25 0,098 6 1 05020 00 0

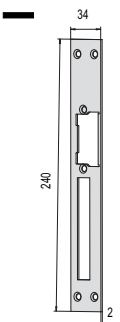

- Square corner steel flat faceplate
- For use with latch locks 44600, 46000, 49000, 57300 series
- SUPPLIED AS STANDARD
 spacer of nylon item 1.06141.85.0 (2 pair 3 mm)

34 0,085 6 1 05021 00 1
 34 0,085 6 1 05021 00 2



Technical features:

- The adjustment mechanism with cam has no protrusions (CISA patent)
- Highly precise lateral adjustment of 2.5 mm using the graduated scale
- The thickness of the "Door" version can be easily adjusted from 4.5 to 10 mm.
- nylon cover to conceal the deadbolt hole on the profile

Finish:

- painted black and stainless steel



Type	Description	For series/item	Kg	Pieces	ITEM			
					Type	Dim.	Hand	Fin.

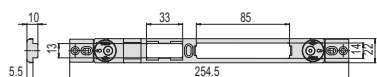

- **REPLACES ITEM 1.06463.22.0**
- Painted black
- Lateral adjustment 2.5 mm
- Nylon cover
- For roller locks use
- Nylon insert ITEM 1.06141.71.0

16000 0,140 12 1 06463 72 0
46000

- **REPLACES ITEM 1.06463.23.0**
- Stainless steel
- Lateral adjustment 2.5 mm
- Nylon cover
- For roller locks use
- Nylon insert ITEM 1.06141.71.0

0,129 12 1 06463 73 0

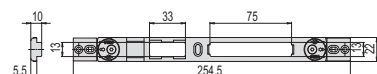

- **Replaces ITEM 1.06463.32.0**
- Painted black
- Lateral adjustment 2.5 mm
- Nylon cover
- For roller locks use nylon insert ITEM 1.06141.71.0

19000, 49000 0,145 12 1 06463 82 0
43200, 43700
43800, 4A000
4A010, 4A100
4A120, 4A200
4A210

- **REPLACES ITEM 1.06463.33.0**
- Stainless steel
- Lateral adjustment 2.5 mm
- Nylon cover
- For roller locks use nylon insert ITEM 1.06141.71.0

19000, 49000 0,141 12 1 06463 83 0
43200, 43700
43800, 4A000
4A010, 4A100
4A120, 4A200
4A210

Type	Description	For series/item	Unit weight Kg	Pieces	ITEM				
					Type	Dim.	Hand	Fin.	Pers. Spec.
	<ul style="list-style-type: none"> • Replaces ITEM 1.06465.22.0 • Painted black • Lateral adjustment 2.5 mm • Nylon cover • For roller locks use nylon insert ITEM 1.06141.71.0 	1.06443.00.21/31	0,112	12	1	06465	72	0	
		1.06443.00.0.26/36							
		1.06443.00.0							
		1 06443.05.0							
		17300, 56300							
		57300, 43200							
		43700, 43800							
		19000, 49000							
		16000, 46000							
		4A000, 4A010							
		4A110, 4A120							
		4A200, 4A210							
	<ul style="list-style-type: none"> • Replaces ITEM 1.06465.23.0 • Stainless steel • Lateral adjustment 2.5 mm • Nylon cover • For roller locks use nylon insert ITEM 1.06141.71.0 	1.06443.00.21/31	0,112	12	1	06465	73	0	
		1.06443.00.0.26/36							
		1.06443.00.0							
		1 06443.05.0							
		17300, 56300							
		57300, 43200							
		43700, 43800							
		19000, 49000							
		16000, 46000							
		4A000, 4A010							
		4A110, 4A120							
		4A200, 4A210							
	<ul style="list-style-type: none"> • Replaces ITEM 1.06465.42.0 • Painted black • Lateral adjustment 2.5 mm 	mid-rail locks:	0,104	12	1	06465	52	0	
		deadbolt only or electric latch only							
	<ul style="list-style-type: none"> • REPLACES ITEM 1.06461.23.0 • Striker kit • for "European groove" profile and supplied as standard: • Striker for central lock (1 pc) • Striker for divertors (2 pcs) • Stainless steel • Lateral adjustment 2.5 mm • Nylon cover 	mid-rail locks:	0,104	12	1	06461	43	0	
		deadbolt only or electric latch only							
	<ul style="list-style-type: none"> • REPLACES ITEM 1.06463.07.0 e 1.06463.21.0 • Painted black • Lateral adjustment 2.5 mm • Nylon cover • For roller locks use nylon insert ITEM 1.06141.70.0 	16000	0,213	12	1	06463	57	0	
		46000							
		16000							
		46000							
		16000							
		46000							
		16000							
		46000							
		16000							
		46000							
		16000							
		46000							

Type	Description	For series/item	Unit weight	Pieces	ITEM			
					Type	Dim.	Hand	Fin.

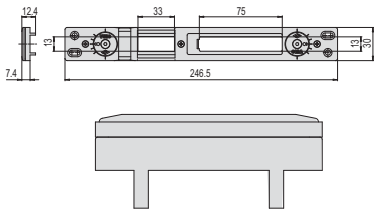

- **REPLACES ITEM 1.06463.17.0 e 1.06463.31.0**
- Painted black
- Lateral adjustment 2.5 mm
- Nylon cover
- For roller locks use nylon insert ITEM 1.06141.70.0

19000, 49000	0,160	12	1	06463 67 0
43200, 43700				
43800, 4A000				
4A010, 4A100				
4A120, 4A200				
4A210				

- **REPLACES ITEM 1.06463.31.0.12**
- Stainless steel
- Lateral adjustment 2.5 mm
- Nylon cover
- For roller locks use nylon insert ITEM 1.06141.70.0

19000, 49000	0,160	12	1	06463 68 0
43200, 43700				
43800, 4A000				
4A010, 4A100				
4A120, 4A200				
4A210				

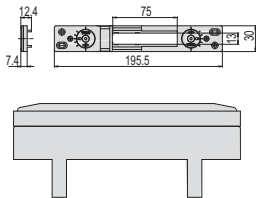

- **REPLACES ITEM 1.06465.07.0 e 1.06465.21.0**
- Painted black
- Lateral adjustment 2.5 mm
- Nylon cover
- For roller locks use nylon insert ITEM 1.06141.70.0

1.06443.00.21/31	0,183	12	1	06465 57 0
1.06443.00.0.26/36				
1.06443.00.0				
1 06443.05.0				
17300, 56300				
57300, 43200				
43700, 43800				
19000, 49000				
16000, 46000				
4A000, 4A010				
4A110, 4A120				
4A200, 4A210				

- **REPLACES ITEM 1.06465.21.0.12**
- Stainless steel
- Lateral adjustment 2.5 mm
- Nylon cover
- For roller locks use nylon insert ITEM 1.06141.70.0

1.06443.00.21/31	0,117	12	1	06465 58 0
1.06443.00.0.26/36				
1.06443.00.0				
1 06443.05.0				
1 06443.05.0				
17300, 56300				
57300, 43200				
43700, 43800				
19000, 49000				
16000, 46000				
4A000, 4A010				
4A110, 4A120				
4A200, 4A210				

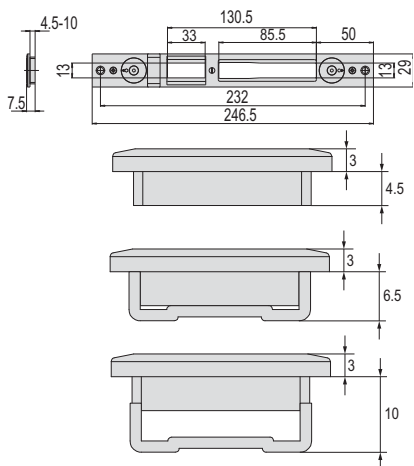

- **REPLACES ITEM 1.06463.24.0**
- Painted black
- Lateral adjustment 2.5 mm
- Nylon cover
- For roller locks use nylon insert ITEM 1.06141.70.0

16000	0,150	12	1	06463 74 0
46000				

- **REPLACES ITEM 1.06463.25.0**
- Stainless steel
- Lateral adjustment 2.5 mm
- Nylon cover
- For roller locks use nylon insert ITEM 1.06141.70.0

16000	0,150	12	1	06463 75 0
46000				

Type	Description	For series/item	Unit weight Pieces	ITEM				
				Type	Dim.	Hand	Fin.	Pers. Spec.
	<ul style="list-style-type: none"> • REPLACES ITEM 1.06463.34.0 • Painted black • Lateral adjustment 2.5 mm • Nylon cover • For roller locks use nylon insert ITEM 1.06141.70.0 	19000, 49000 43200, 43700 43800, 4A000 4A010, 4A100 4A120, 4A200 4A210	0,187	12	1	06463	84	0
	<ul style="list-style-type: none"> • REPLACES ITEM 1.06463.35.0 • Stainless steel • Lateral adjustment 2.5 mm • Nylon cover • For roller locks use nylon insert ITEM 1.06141.70.0 	19000, 49000 43200, 43700 43800, 4A000 4A010, 4A100 4A120, 4A200 4A210	0,158	12	1	06463	85	0
	<ul style="list-style-type: none"> • REPLACES ITEM 1.06465.24.0 • Painted black • Lateral adjustment 2.5 mm • Nylon cover • For roller locks use nylon insert ITEM 1.06141.70.0 	1.06443.00.21/31 1.06443.00.0.26/36 1.06443.00.0 1 06443.05.0 17300, 56300 57300, 43200 43700, 43800 19000, 49000 16000, 46000 4A000, 4A010 4A110, 4A120 4A200, 4A210	0,166	12	1	06465	74	0
	<ul style="list-style-type: none"> • REPLACES ITEM 1.06465.25.0 • Stainless steel • Lateral adjustment 2.5 mm • Nylon cover • For roller locks use nylon insert ITEM 1.06141.70.0 	1.06443.00.21/31 1.06443.00.0.26/36 1.06443.00.0 1 06443.05.0 17300, 56300 57300, 43200 43700, 43800 19000, 49000 16000, 46000 4A000, 4A010 4A110, 4A120 4A200, 4A210	0,125	12	1	06465	75	0

Type	Description	For series/item	Unit weight 	Pieces 	ITEM				
					Type	Dim.	Hand	Fin.	Pers. Spec.

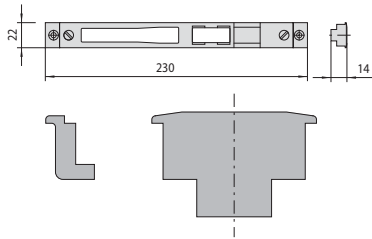

- Lateral adjustment 2,5 mm
- For roller locks use nylon insert item 1.06141.71.0

16205, 16215, 16225, 16425, 16525, 16625, 16725, 46200, 46210, 46215, 46220, 46225, 46230, 46250, 46420, 46425, 46435, 46445, 46450, 46520, 46525, 46550, 46625, 46650, 46725, 46750	0,173	12	1	06463 05 0
--	-------	----	---	-------------------

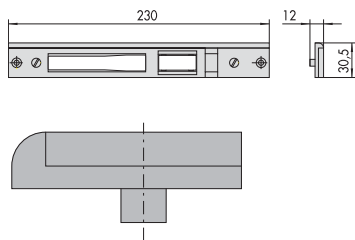

- Lateral adjustment 2,5 mm
- For roller locks use nylon insert item 1.06141.70.0

16205, 16215, 16225, 16425, 16525, 16625, 16725, 46200, 46210, 46215, 46220, 46225, 46230, 46250, 46420, 46425, 46435, 46445, 46450, 46520, 46525, 46550, 46625, 46650, 46725, 46750	0,166	12	1	06463 06 0
--	-------	----	---	-------------------

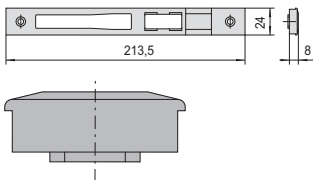

- For roller locks use nylon insert item 1.06141.71.0

16205, 16215, 16225, 16425, 16525, 16625, 16725, 46200, 46210, 46215, 46220, 46225, 46230, 46250, 46420, 46425, 46435, 46445, 46450, 46520, 46525, 46550, 46625, 46650, 46725, 46750	0,150	12	1	06463 09 0
--	-------	----	---	-------------------

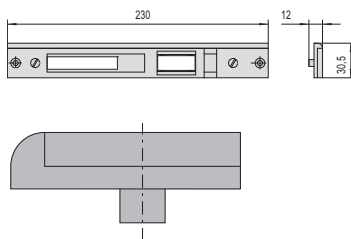

- Lateral adjustment 2,5 mm
- For roller locks use nylon insert item 1.06141.70.0

18128, 18129, 18225, 18229, 18426, 18526, 48128, 48129, 48153, 48154, 48225, 48229, 48250, 48254, 48426, 48451, 48526, 48551, 48626, 48726	0,180	12	1	06463 16 0
---	-------	----	---	-------------------

Type	Description	For series/item	Unit weight Kg	Pieces	ITEM			
					Type	Dim.	Hand	Fin.
	<ul style="list-style-type: none"> For roller locks use nylon insert item 1.06141.71.0 	1 06443 00 0,	0,053	12	1	06465	02	0
		1 06443 05 0, 1 06453 05 0, 46200,46210, 46220,46420, 46520,48123, 48220,48224, 48420,48520, 56357,57330, 57335,57370, 57375						
	<ul style="list-style-type: none"> For roller locks use nylon insert item 1.06141.71.0 	1 06443 00 0,	0,108	12	1	06465	03	0
		1 06443 05 0, 1 06443 31 0, 1 06443 36 0, 1 06443 41 0, 1 06443 46 0, 1 06453 05 0, 17352,17357, 19000,43700, 43800,46200, 46210,46220, 46420,46520, 49000,56357, 57312,57317, 57320,57325, 57330,57335, 57352,57357, 57360,57365, 57370,57375						
	<ul style="list-style-type: none"> Lateral adjustment 2,5 mm For roller locks use nylon insert item 1.06141.71.0 	1 06443 00 0,	0,125	12	1	06465	05	0
		1 06443 05 0, 1 06443 31 0, 1 06443 36 0, 1 06443 41 0, 1 06443 46 0, 1 06453 05 0, 17352,17357, 46200,46210, 46220,46420, 46520,56357, 57312,57317, 57320,57325, 57330,57335, 57352,57357, 57360,57365, 57370,57375						

Type	Description	For series/item	Unit weight 	Pieces 	ITEM			
					Type	Dim.	Hand	Fin.

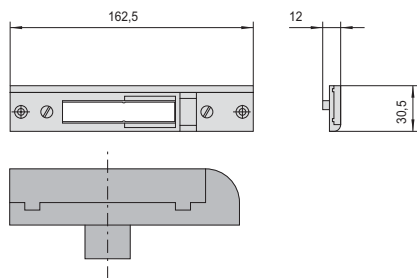

- Lateral adjustment 2,5 mm
- For roller locks use nylon insert item 1.06141.70.0

1 06443 00 0,	0,122	12	1 06465 06 0
1 06443 05 0,			
1 06443 31 0,			
1 06443 36 0,			
1 06443 41 0,			
1 06443 46 0,			
1 06453 05 0,			
17352,17357,			
46200,46210,			
46220,46420,			
46520,57312,			
57317,57320,			
57325,57330,			
57335,57352,			
57357,57360,			
57365,57370,			
57375			

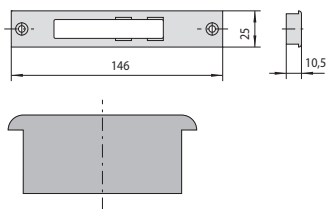

- For roller locks use nylon insert item 1.06141.70.0
- TO BE DISCONTINUED**

1 06443 00 0,	0,099	12	1 06465 08 0
1 06443 05 0,			
1 06453 05 0,			
46200,46210,			
46220,46420,			
46520			

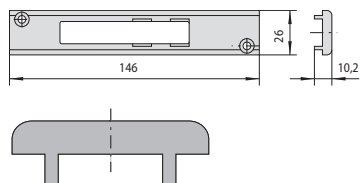

- For roller locks use nylon insert item 1.06141.70.0
- TO BE DISCONTINUED**

1 06443 00 0,	0,115	12	1 06465 10 0
1 06443 05 0,			
1 06453 05 0,			
46200,46210,			
46220,46420,			
46520			

Type	Description	For series/item	Unit weight Kg	Pieces	ITEM				
					Type	Dim.	Hand	Fin.	Pers. Spec.
	• Black nylon rose	02400	0,001	100	1	06002	00	0	
	• Set of black nylon roses for European profile cylinders		0,004	100	1	06012	01	0	
	• Set of black nylon roses for oval cylinders		0,004	100	1	06027	01	0	
	• Nickel-plated steel screw	1 06119 00 0, 1 06123 00 1, 1 06123 03 0, 1 06123 04 0, 1 06142 00 0, 1 06142 02 0	0,006	50	1	06048	02	0	
	• Nickel-plated steel screw	1 06119 00 0, 1 06123 00 1, 1 06123 03 0, 1 06123 04 0, 1 06142 00 0, 1 06142 02 0	0,008	50	1	06048	03	0	
	• Zinc plated steel flat striker	44220, 44221, 44225, 44226	0,050	25	1	06077	16	0	
	• Zinc plated steel flat striker	44220, 44221, 44225, 44226	0,070	25	1	06077	20	0	
	• Zinc plated steel flat striker	44230, 44231, 44235, 44236	0,052	25	1	06078	16	0	
	• Zinc plated steel flat striker	44230, 44231, 44235, 44236	0,070	25	1	06078	20	0	
	• Zinc plated steel flat striker	44240, 44241, 44245, 44246	0,030	25	1	06079	16	0	
	• Zinc plated steel flat striker	44240, 44241, 44245, 44246	0,045	25	1	06079	20	0	
	• Zinc plated steel flat striker	44360, 44361, 44460, 44461	0,037	25	1	06079	77	0	

Type	Description	For series/item	Unit weight Kg	Pieces	ITEM				
					Type	Dim.	Hand	Fin.	Pers.
	<ul style="list-style-type: none"> • Zinc plated steel flat striker 	44237, 44238	0,025	25	1	06080	16	0	
	<ul style="list-style-type: none"> • Zinc plated steel flat striker 	44237, 44238	0,034	25	1	06080	20	0	
	<ul style="list-style-type: none"> • Brass floor striker diameter 11 mm. • USED FOR: extension bolts with 10 mm. diameter rods 	1 06415 00 0, 1 06441 15 0, 1 07088 03 0, 1 07088 04 0, 43090, 43190, 43690, 46445, 52526, 53131, 53137, 53151, 53157, 56255, 57015, 57019, 57020, 57024, 57033, 57055, 57215, 57217, 57255, 57259, 57265, 57296, 57831, 57837, 57851, 57857	0,016	12	1	06086	00	0	
	<ul style="list-style-type: none"> • Brass floor striker, diameter 9 mm. • USED FOR: Internal extension bolts with 8 mm. diameter rods 	1 06441 00 0, 1 06441 10 0, 1 06441 20 0, 1 06451 00 0, 1 06451 10 0, 1 07088 00 0	0,013	12	1	06086	01	0	
	<ul style="list-style-type: none"> • Brass floor striker with spring dust-cover, diameter 12 mm. • USED FOR: Internal extension bolts with 8 and 10 mm. diameter rods multi-point locks series 46445 extension boltextension boltfor Multitop item 1.06449.11.0 	1 06415 00 0, 1 06441 00 0, 1 06441 10 0, 1 06441 15 0, 1 06441 20 0, 1 06451 00 0, 1 06451 10 0, 1 07088 00 0, 1 07088 03 0, 43090, 43190, 43690, 46445, 52526, 53131, 53137, 53151, 53157, 56255, 57015, 57019, 57020, 57024, 57033, 57055, 57215, 57217, 57255, 57259, 57265, 57296, 57831, 57837, 57851, 57857	0,020	12	1	06086	02	0	
	<ul style="list-style-type: none"> • Nylon push-button for electric locks with hold-open device (except series 14020 and 14021) 		0,020	12	1	06110	15	0	

Type	Description	For series/item	Unit weight Kg	Pieces	ITEM				
					Type	Dim.	Hand	Fin.	Pers. Spec.
	<ul style="list-style-type: none"> • Set of chrome-plated brass key guides 	17352, 17357, 57312, 57317, 57320, 57325, 57330, 57335, 57352, 57357, 57360, 57365, 57370, 57375	0,038	5	1	06123	00	1	
	<ul style="list-style-type: none"> • Set of nylon key guides 	17352, 17357, 57312, 57317, 57320, 57325, 57330, 57335, 57352, 57357, 57360, 57365, 57370, 57375	0,035	5	1	06123	03	0	
	<ul style="list-style-type: none"> • Set of nylon faceplate spacers (8 mm.) for Alpha and Esedra Doors Shops profiles • Fitting both mid-rail horizontal locks and narrow frame upright locks 		0,010	25	1	06141	52	0	
	<ul style="list-style-type: none"> • Set of nylon faceplate spacers (2 mm.) 	44200, 44600	0,002	25	1	06141	53	0	
	<ul style="list-style-type: none"> • Nylon roller insert for striker of locks series 44600 		0,003	25	1	06141	55	0	
	<ul style="list-style-type: none"> • Nylon roller insert for striker of locks series 57300 	1 56357 10 0, 1 56357 90 0, 1 56358 90 0	0,004	12	1	06141	56	0	
	<ul style="list-style-type: none"> • Nylon faceplate spacer (2.5 mm.) for mid-rail locks with 16 and 20 mm. faceplate 		0,011	25	1	06141	57	0	
	<ul style="list-style-type: none"> • Nylon faceplate spacer (5 mm.) for locks with 16 and 20 mm. faceplate 		0,016	25	1	06141	63	0	
	<ul style="list-style-type: none"> • Set of nylon faceplate spacers (5 mm.) for locks and upright locks 		0,003	25	1	06141	65	0	
	<ul style="list-style-type: none"> • Nylon faceplate spacer (3 mm.) for locks with 16 and 20 mm. faceplate 		0,010	25	1	06141	66	0	
	<ul style="list-style-type: none"> • Nylon faceplate spacer (5 mm.) for locks with 16 and 20 mm. faceplate 		0,010	25	1	06141	67	0	

Type	Description	For series/item	Unit weight Pieces	ITEM			
				Type	Dim.	Hand	Fin.
	<ul style="list-style-type: none"> • Set of nylon faceplate spacers (3 mm.) 	16200, 17000, 19200, 46200, 49200, 56357, 57000	0,005 25	1	06141	68	0
	<ul style="list-style-type: none"> • Set of nylon faceplate spacers (2 mm.) 	16200, 17000, 19200, 46200, 49200, 56357, 57000	0,001 25	1	06141	69	0
	<ul style="list-style-type: none"> • Nylon roller insert 	1 06463 06 0, 1 06463 07 0, 1 06463 16 0, 1 06463 17 0, 1 06463 24 0, 1 06463 34 0, 1 06465 06 0, 1 06465 07 0, 1 06465 08 0, 1 06465 09 0, 1 06465 10 0, 1 06465 24 0	0,004 12	1	06141	70	0
	<ul style="list-style-type: none"> • Nylon roller insert 	1 06463 05 0, 1 06463 08 0, 1 06463 09 0, 1 06463 15 0, 1 06463 18 0, 1 06463 19 0, 1 06463 21 0, 1 06463 22 0, 1 06463 23 0, 1 06463 31 0, 1 06463 32 0, 1 06463 33 0, 1 06465 02 0, 1 06465 03 0, 1 06465 05 0, 1 06465 21 0, 1 06465 22 0, 1 06465 23 0	0,003 12	1	06141	71	0
	<ul style="list-style-type: none"> • Nylon cover for DOUBLE-LEAF Ekip 50 door profil 	1 06463 05 0, 1 06463 15 0, 1 06465 05 0	0,010 12	1	06141	74	0
	<ul style="list-style-type: none"> • Nylon roller insert 	1 06141 40 0, 1 06141 41 0, 1 06141 42 0, 1 06141 43 0, 1 06141 44 0, 1 06141 46 0	0,002 12	1	06141	75	0

Type	Description	For series/item	Unit weight Kg	Pieces	ITEM			
					Type	Dim.	Hand	Fin.
	<ul style="list-style-type: none"> Nylon roller insert 	1 06285 30 0, 1 06285 32 0, 1 06285 34 0, 1 06285 36 0, 1 06285 38 0, 1 06285 40 0, 1 06285 42 0, 1 06285 44 0	0,002	12	1	06141	76	0
	<ul style="list-style-type: none"> Pair of spacer 1,5 mm for striker for sections Domal Shops 	1 06285 36 0, 1 06463 04 0, 1 06463 14 0, 1 06465 04 0, 1 06465 08 0, 1 06465 14 0	0,005	25	1	06141	77	0
	<ul style="list-style-type: none"> Nylon faceplate spacer (3 mm.) 	16200, 18200, 46200, 48200	0,020	12	1	06141	78	0
 	<ul style="list-style-type: none"> Nylon cover for thermal cut aluminium profiles for outward opening doors (lip height from 7.5 to 10 mm) 	1 06141 40 0, 1 06285 36 0, 1 06463 04 0, 1 06463 14 0, 1 06463 24 0, 1 06463 25 0, 1 06463 34 0, 1 06463 35 0, 1 06465 04 0, 1 06465 24 0, 1 06465 25 0, 1 06465 34 0, 1 06465 35 0, 1 06465 44 0	0,019	25	1	06141	79	0
	<ul style="list-style-type: none"> Upper striker for extension bolt Black nylon 	1 07089 52 0	0,022	25	1	06141	80	0
	<ul style="list-style-type: none"> Nylon roller insert 	1 06278 06 0, 1 06278 28 0	0,002	25	1	06141	82	0

Type	Description	For series/item	Unit weight Pieces	ITEM			
				Type	Dim.	Hand	Fin.
	<ul style="list-style-type: none"> Nylon faceplate spacer (3 mm.) 	1 05020 00 0	0,012 12	1 06141 84 0			
	<ul style="list-style-type: none"> Nylon faceplate spacer (3 mm.) 	1 05021 00 1, 1 05021 00 21	0,025 25	1 06141 85 0			
	<ul style="list-style-type: none"> Nylon roller insert 	1 06232 05 0, 1 06461 25 0, 1 06461 30 0, 1 06461 35 0, 1 06461 40 0, 1 06461 45 0	0,002 12	1 06141 86 0			
	<ul style="list-style-type: none"> Set of additional spacers for cylinder protection roses for profiles wider than 65-87 mm. Spacers from 2 mm. (11 pieces) Screws M5 x 110 mm. (2 pieces) 	1 06460 05 0	0,145 1	1 06141 87 0			
 	<ul style="list-style-type: none"> Nylon cover for thermal cut aluminium profiles for outward opening doors (lip height from 3 to 7.5 mm) 	1 06463 24 0, 1 06463 25 0, 1 06463 34 0, 1 06463 35 0, 1 06465 24 0, 1 06465 25 0, 1 06465 34 0, 1 06465 35 0	0,019 25	1 06141 89 0			
	<ul style="list-style-type: none"> Spacer + long lip for electric strikes 		0,031 12	1 06141 95 0			
	<ul style="list-style-type: none"> Faceplate long lip for electric strikes 		0,047 12	1 06141 96 0			

Type	Description	For series/item	Unit weight Kg	Pieces	ITEM				
					Type	Dim.	Hand	Fin.	Pers. Spec.
	<ul style="list-style-type: none"> Noise proof bushes for bolts diameter 8,5 mm. (pc.2) diameter 10 mm. (pc.1) 	1 06441 00 0, 1 06441 10 0, 1 06441 20 0, 1 06451 00 0, 1 06451 10 0, 1 07088 00 0	0,004	25	1	06147	00	0	
	<ul style="list-style-type: none"> Noise proof bushes for bolt diameter 10 mm. (1 piece) 	1 06441 00 0, 1 06441 10 0, 1 06441 20 0, 1 06451 00 0, 1 06451 10 0, 1 07088 00 0	0,001	100	1	06147	01	0	
	<ul style="list-style-type: none"> Zinc-plated steel flat strike 	44650, 44660, 44665, 44680	0,096	25	1	06157	00	0	
	<ul style="list-style-type: none"> Zinc-plated steel flat strike 	44670	0,100	25	1	06167	00	0	
	<ul style="list-style-type: none"> Nylon guide rod 	1 06441 00 0, 1 06441 10 0, 1 06441 20 0, 1 06443 00 0, 1 06443 21 0, 1 06443 31 0, 1 06443 41 0, 1 06451 00 0, 1 06451 10 0, 1 06453 05 0, 1 07088 00 0	0,003	25	1	06224	00	0	
	<ul style="list-style-type: none"> Zinc plated steel flat striker Includes a pair of spacers item 1.06141.65.0 (roller insert item. 1.06141.86.0) 	44600, 46000	0,065	25	1	06232	05	0	
	<ul style="list-style-type: none"> Zinc plated steel flat striker Includes a pair of spacers item 1.06141.65.0 	1 06443 00 0, 1 06443 05 0, 1 06453 05 0	0,069	25	1	06232	06	0	
	<ul style="list-style-type: none"> Zinc plated steel striker 	46215, 46217, 46225, 46227, 46325, 46327	0,086	25	1	06232	20	0	
	<ul style="list-style-type: none"> Stainless steel faceplate (25 mm.) 	46215, 46217, 46225, 46227	0,141	12	1	06233	00	0	

Type	Description	For series/item	Unit weight Kg	Pieces	ITEM				
					Type	Dim.	Hand	Fin.	Pers.
	<ul style="list-style-type: none"> Stainless steel faceplate (25 mm.) 	16215, 16217, 16225, 16227	0,160	12	1	06233	01	0	
	<ul style="list-style-type: none"> Stainless steel faceplate (25 mm.) 	46230, 46250, 46252	0,130	12	1	06233	02	0	
	<ul style="list-style-type: none"> Stainless steel faceplate (25 mm.) 	46200, 46210, 46212, 46220, 46222, 46240, 46260, 46265	0,144	12	1	06233	03	0	
	<ul style="list-style-type: none"> Set of threaded bushes (M5) in nylon 	1 07088 00 0, 57317, 57325, 57335	0,010	12	1	06290	00	0	
	<ul style="list-style-type: none"> Set of threaded bushes (M8) in metal 	1 06441 20 0, 16325, 17358, 56358, 56378, 57358, 57378	0,050	12	1	06290	05	0	
	<ul style="list-style-type: none"> Set of threaded bushes (M8) in metal 	19225, 49225, 49228, 49250	0,050	12	1	06290	06	0	
	<ul style="list-style-type: none"> Pair of threaded steel bushings (M8), anti-unscrewing 	46800, 46301, 56016, 57016, 57035, 57226, 57318, 57336	0,025	12	1	06290	10	0	
	<ul style="list-style-type: none"> Zinc plated steel saw resistant rod diameter 8 mm. Lateral push resistance KN 8 	1 06441 00 0, 1 06441 10 0, 1 06441 20 0, 1 06451 00 0, 1 06451 10 0, 1 07088 00 0	0,036	12	1	06291	01	0	
	<ul style="list-style-type: none"> Zinc plated hardened steel single-piece rod diameter 8 mm. Lateral push resistance KN 14 	1 06441 00 0, 1 06441 10 0, 1 06441 20 0, 1 06451 00 0, 1 06451 10 0, 1 07088 00 0	0,038	12	1	06291	06	0	

Type	Description	For series/item	Unit weight Kg	Pieces	ITEM				
					Type	Dim.	Hand	Fin.	Pers. Spec.
	<ul style="list-style-type: none"> • Zinc-plated joining pin for bolt extension rods 	1 06415 00 0, 1 06416 00 0, 1 06441 00 0, 1 06441 10 0, 1 06441 15 0, 1 06441 20 0, 1 06451 00 0, 1 06451 10 0, 1 07088 00 0, 1 07088 03 0 1 07088 04 0	0,016	12	1	06291	20	0	
	<ul style="list-style-type: none"> • Stainless steel flat striker 25 x 3 mm. 	1 06443 00 0, 1 06443 05 0, 1 06453 05 0, 46200, 46210, 46212, 46220, 46222, 46240, 46260, 46265, 46420, 46520	0,057	12	1	06459	01	0	
	<ul style="list-style-type: none"> • Stainless steel flat striker 25 x 1.5 mm. 	1 06443 00 0, 1 06443 05 0, 1 06453 05 0, 46200, 46210, 46212, 46220, 46222, 46240, 46260, 46265, 46420, 46520	0,034	12	1	06459	02	0	
	<ul style="list-style-type: none"> • Sinterised stainless steel cylinder protection rose 	16000, 46000	0,125	1	1	06460	00	0	
	<ul style="list-style-type: none"> • Protective rose for cylinders RS3, ASTRAL (with long key, CL special execution) and ASIX in chrome-plated carbonitrided steel complete with: 2 mm spacers (19pcs), 1 mm spacer (2pcs) screws M5 x 73 mm. inside escutcheon • ON REQUEST: external ring item 1.06473.60.0 in polished, chrome-plated satin-finished steel 	19000, 49000	0,485	1	1	06460	05	0	

Type	Description	For series/item	Unit weight Kg	Pieces	ITEM				
					Type	Dim.	Hand	Fin.	Pers.
	<ul style="list-style-type: none"> • Protective rose for European cylinders - carbonitrided and tempered steel body - Stainless steel anti-drill rotating plate - 2 M6 x 18 mm screws; - 2 bushes with fixing springs - 2 tear-off threaded inserts 		0,485	1	1	06460	70	0	45
			0,485	1	1	06460	70	0	N5
			0,485	1	1	06460	70	0	44
			0,485	1	1	06460	70	0	C2
			0,485	1	1	06460	70	0	C3
			0,485	1	1	06460	70	0	N8
		<ul style="list-style-type: none"> • AVAILABLE FINISH - White (fin. 45) - Dark grey (fin. N5) - Black (fin. 44) - PVD satin chrome (fin. C2) - Polished brass PVD (fin. C3) - PVD polished chrome (fin. N8) 							
	<ul style="list-style-type: none"> • Stainless steel flat striker 25 x 3 mm. 	46215, 46217, 46225, 46227, 46425, 46435, 46445, 46525, 46625, 46725	0,082	12	1	06461	01	0	
	<ul style="list-style-type: none"> • Stainless steel flat striker 25 x 1.5 mm. 	46215, 46217, 46225, 46227, 46425, 46435, 46445, 46525, 46625, 46725	0,050	12	1	06461	02	0	
	<ul style="list-style-type: none"> • Stainless steel flat striker 24 x 1.5 mm. 	19000, 49000	0,053	12	1	06461	07	0	
	<ul style="list-style-type: none"> • Stainless steel flat striker 25 x 3 mm. 	46230, 46250, 46252, 46450, 46550, 46650, 46750	0,085	12	1	06461	11	0	
	<ul style="list-style-type: none"> • Stainless steel flat striker 24 x 1,5 mm. 	19000, 49000	0,034	12	1	06461	12	0	
	<ul style="list-style-type: none"> • Stainless steel flat striker 36x2 mm for FORSTER "UNICO" profile for Multitop locks with latch+deadb and roller+deadb 	19000, 49000	0,080	12	1	06461	17	0	
	<ul style="list-style-type: none"> • Stainless steel flat striker 25 x 3 mm. 	57320, 57325, 57360, 57365	0,075	12	1	06461	20	0	

Type	Description	For series/item	Unit weight Pieces	ITEM			
				Type	Dim.	Hand	Fin.
	<ul style="list-style-type: none"> Stainless steel flat striker 25 x 3 mm. 	56357, 57312, 57317, 57330, 57335, 57352, 57357, 57370, 57375	0,067 12	1	06461	21	0
	<ul style="list-style-type: none"> Stainless steel flat striker 36 x 2 mm. 	19000, 49000	0,046 12	1	06461	22	0
	<ul style="list-style-type: none"> Stainless steel "U" striker 24x6 mm for locks with latch/roller and swing bolt (roller insert item 1.06141.86.0) 		0,098 12	1	06461	25	0
	<ul style="list-style-type: none"> Stainless steel "U" striker 24x6 mm for locks with swing bolt only 		0,065 12	1	06461	26	0
	<ul style="list-style-type: none"> Stainless steel flat striker 24 x 3 mm. For roller locks use nylon insert item 1.06141.86.0 	19000, 49000	0,093 12	1	06461	30	0
	<ul style="list-style-type: none"> Stainless steel flat striker 24 x 3 mm. 	19000, 49000	0,065 12	1	06461	34	0
	<ul style="list-style-type: none"> Stainless steel U-shaped striker 24 x 6 mm. For roller locks use nylon insert item 1.06141.86.0 	19000, 49000	0,098 12	1	06461	35	0
	<ul style="list-style-type: none"> Stainless steel U-shaped striker 24 x 6 mm. 	19000, 49000	0,065 12	1	06461	39	0
	<ul style="list-style-type: none"> Stainless steel flat striker 24 x 3 mm. with deadbolt protection case For roller locks use nylon insert item 1.06141.86.0 	19000, 49000	0,182 12	1	06461	40	0

Type	Description	For series/item	Unit weight Kg	Pieces	ITEM			
					Type	Dim.	Hand	Fin.
	<ul style="list-style-type: none"> Stainless steel U-shaped striker 24 x 6 mm. For roller locks use nylon insert item 1.06141.86.0 	19000, 49000	0,182	12	1	06461	45	0
	<ul style="list-style-type: none"> Stainless steel U-shaped striker 25 x 3 mm with nylon slide 	16205, 16207, 16215, 16217, 16225, 16227, 16425, 16435, 16445, 16525, 16625, 16725	0,077	12	1	06462	01	0
	<ul style="list-style-type: none"> Stainless steel U-shaped striker 25 x 3 mm. 	17352, 17357, 57352, 57357, 57370, 57375	0,058	12	1	06462	20	0
	<ul style="list-style-type: none"> Brass oval inside escutcheon for European profile cylinders Finish: Polished lacquered brass 		0,100	12	1	06473	20	0
	<ul style="list-style-type: none"> Finish: Nickel-plated, satin-finished and chrome brass 		0,100	12	1	06473	20	0 B1
	<ul style="list-style-type: none"> Brass oval inside escutcheon for European profile cylinders with adjustable shaft Finish: Polished lacquered brass 		0,100	12	1	06473	30	0
	<ul style="list-style-type: none"> Finish: Nickel-plated, satin-finished and chrome brass 		0,100	12	1	06473	30	0 B1
	<ul style="list-style-type: none"> Polished, chrome-plated satin-finished external ring 	1 06460 05 0	0,025	12	1	06473	60	0
	<ul style="list-style-type: none"> Set of nylon contacts for electric locks complete with spacers: 2 mm. (6 pieces) 5 mm. (1 piece) 		0,047	6	1	06511	00	0

Type	Description	For series/item	Unit weight Kg	Pieces	ITEM				
					Type	Dim.	Brand	Fin.	Pers. Spec.
	<ul style="list-style-type: none"> • Set of coils • 12 V ac CE 	14010, 14011, 14012, 14017	0,030	6	1	07013	00	0	
	<ul style="list-style-type: none"> • Zinc plated steel flat striker 	44210	0,035	25	1	07027	00	0	
	<ul style="list-style-type: none"> • Zinc plated steel flat striker 	45010, 45110	0,035	25	1	07028	00	0	
	<ul style="list-style-type: none"> • Brass flat striker 	45100	0,035	25	1	07028	10	0	
	<ul style="list-style-type: none"> • Set of coils • 12 V ac CE 	14020, 14021	0,027	6	1	07047	00	0	
	<ul style="list-style-type: none"> • Stainless steel floor striker 	-	-	6	1	07072	75	0	
	<ul style="list-style-type: none"> • Set of coils • 12 V ac CE 	14350, 14351, 14352, 14450, 14451, 14452, 14460, 14461, 14462, 14510, 14511, 14512, 15500, 16000, 17500, 19000	0,035	6	1	07086	00	0	
	<ul style="list-style-type: none"> • Set of coils • 24 V ac CE 	14350, 14351, 14352, 14450, 14451, 14452, 14460, 14461, 14462, 14510, 14511, 14512, 15500, 16000, 17500, 19000	0,035	6	1	07086	01	0	
	<ul style="list-style-type: none"> • OFFSET zinc-plated steel dogging device, complete with spacers and top striker • For safety locks with internal extension bolt rods • May be combined with extension bolts set item 1.07088.03.0 	40295	0,060	1	1	07089	52	0	
	<ul style="list-style-type: none"> • Set of coils • 12 V ac CE 	17352, 17353, 17357, 17358	0,035	6	1	07128	00	0	

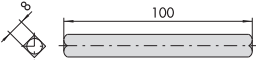
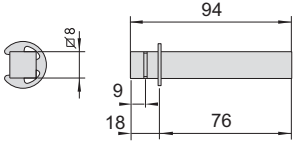
Type	Description	For series/item	Unit weight		ITEM			
			Kg	Pieces	Type	Dim.	Hand	Fin.
	• Steel spindle		0,050	6	1	07206	00	0
	• Steel spindle		0,050	6	1	07085	79	0

Type	Description	For series/item	Unit weight Pieces	ITEM				
				Type	Dim.	Hand	Fin.	Pers.
		14010, 14020, 14350, 14450, 14510, 44110, 44115, 44140, 44145, 44150, 44155, 44160, 44210, 44227, 44240, 44245, 44350, 44450	0,016	25	1	06062	00	0
		14010, 14020, 14350, 14450, 14510, 44110, 44115, 44140, 44145, 44150, 44155, 44160, 44210, 44227, 44240, 44245, 44350, 44450	0,019	25	1	06072	00	0
		1 06443 00 0, 1 06443 05 0, 1 06453 05 0, 17352, 17357, 46200, 46210, 46220, 46420, 57312, 57317, 57330, 57335, 57352, 57357, 57370, 57375	0,024	25	1	06141	35	0
		57320, 57325, 57360, 57365	0,030	25	1	06141	36	0
		1 06443 00 0, 1 06443 05 0, 1 06453 05 0, 17352, 17357, 46200, 46210, 46220, 57312, 57317, 57330, 57335, 57352, 57357, 57370, 57375	0,034	25	1	06141	37	0
		57320, 57325, 57360, 57365	0,030	25	1	06141	38	0

Type	Description	For series/item	Unit weight Pieces	ITEM				
				Type	Dim.	Hand	Fin.	Pers. Spec.

	<p>• For roller locks item 57320 - 57325 - 57360 - 57365 use nylon insert item 1.06141.75.0</p>	17352, 17357, 57312, 57317, 57320, 57325, 57330, 57335, 57352, 57357, 57360, 57365, 57370, 57375	0,035	25	1 06141 40 0				
--	---	--	-------	----	--------------	--	--	--	--

		17352, 17357, 57312, 57317, 57320, 57325, 57330, 57335, 57352, 57357, 57360, 57365, 57370, 57375	0,025	25	1 06141 42 0				
--	--	--	-------	----	--------------	--	--	--	--

		17352, 17357, 57312, 57317, 57320, 57325, 57330, 57335, 57352, 57357, 57360, 57365, 57370, 57375	0,029	25	1 06141 44 0				
--	--	--	-------	----	--------------	--	--	--	--

		44220, 44221, 44225, 44226	0,014	25	1 06277 01 0				
--	--	----------------------------	-------	----	--------------	--	--	--	--

		14460, 14461, 44120, 44121, 44360, 44361, 44460, 44461	0,018	25	1 06277 02 0				
--	--	--	-------	----	--------------	--	--	--	--

		44130, 44230, 44235, 44236, 44237, 44238, 44370, 44371, 44470, 44471	0,030	25	1 06277 03 0				
--	--	--	-------	----	--------------	--	--	--	--

Type	Description	For series/item	Unit weight Kg	Pieces	ITEM				
					Type	Dim.	Hand	Fin.	Pers.

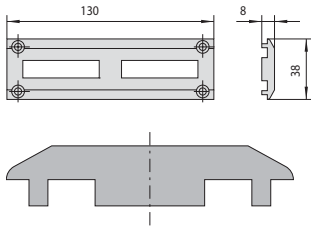

44220, 44221, 44225,
44226

0,030 25 1 06277 10 0

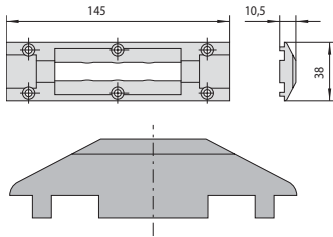

14460, 14461, 44120,
44121, 44360, 44361,
44460, 44461

0,026 25 1 06277 11 0

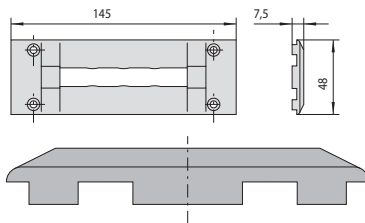

14460, 44120, 44360,
44460

0,021 25 1 06277 14 0

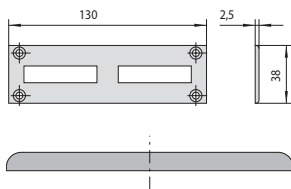

44221, 44226

0,015 25 1 06277 28 0

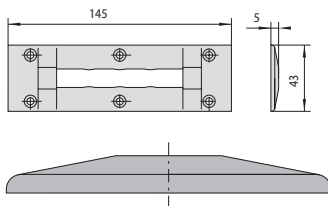

14461, 44121, 44361,
44461

0,018 25 1 06277 32 0

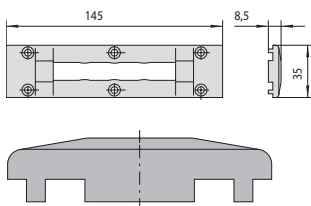

14461, 44121, 44361,
44461

0,030 25 1 06277 41 0

Type	Description	For series/item	Unit weight 	Pieces 	ITEM					
					Type	Dim.	Hand	Fin.	Pers.	Spec.
	14461, 44121, 44361, 44461	0,030 25	1 06277 44 0							
	44219, 44221, 44224, 44226	0,012 25	1 06277 76 0							
	14461, 14462, 44121, 44361, 44362, 44461, 44462	0,016 25	1 06277 77 0							
	44131, 44231, 44236, 44238, 44371, 44471	0,016 25	1 06277 78 0							
	14461, 14462, 44121, 44361, 44362, 44461, 44462	0,030 25	1 06277 80 0							
	44219, 44220, 44221, 44224, 44225, 44226	0,007 25	1 06277 88 0							

Type	Description	For series/item	Unit weight Pieces	ITEM				
				Type	Dim.	Hand	Fin.	Pers. Spec.

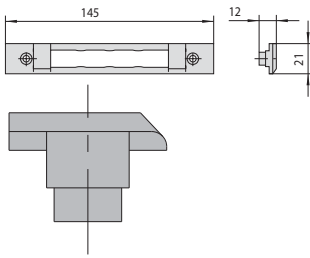

14460, 14461, 14462,
44120, 44121, 44360,
44361, 44362, 44460,
44461, 44462

0,013 25 1 06277 89 0

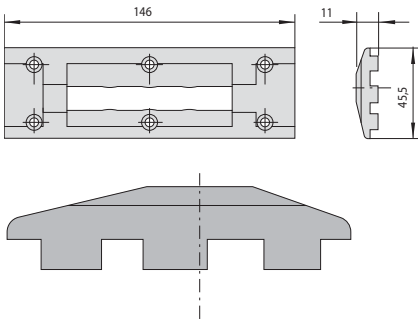

14461, 44121, 44361,
44461

0,030 25 1 06277 92 0

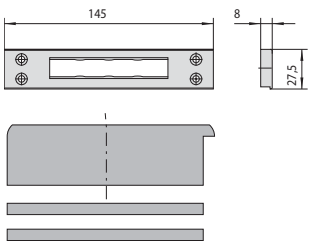

14460, 14461, 14462,
44120, 44121, 44360,
44361, 44362, 44460,
44461, 44462

0,030 25 1 06277 95 0

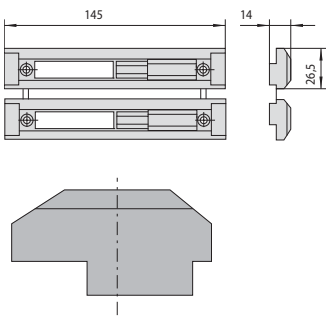

44131, 44231, 44236,
44238, 44371, 44471

0,048 12 1 06277 98 0

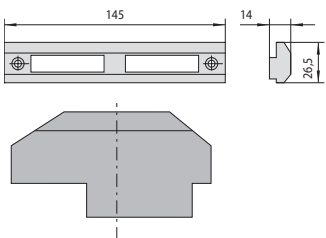

44221, 44226

0,023 25 1 06277 99 0

Type	Description	For series/item	Unit weight 	Pieces 	ITEM	Type	Dim.	Hand	Fin.	Pers.	Spec.
	44219, 44220, 44221, 44224, 44225, 44226	0,019 25 1 06278 01 0									
	14460, 14461, 14462, 44120, 44121, 44360, 44361, 44362, 44460, 44461, 44462	0,022 25 1 06278 02 0									
	14011, 14021, 14351, 14451, 14461, 14511, 44111, 44116, 44121, 44141, 44146, 44151, 44156, 44161, 44228, 44241, 44246, 44351, 44361, 44451, 44461	0,020 25 1 06278 04 0									
	44131, 44231, 44236, 44238, 44371, 44471	0,017 25 1 06278 05 0									
	<ul style="list-style-type: none"> For roller locks item 44230 - 44235 - 44370 - 44470 use nylon insert item 1.06141.82.0 	0,020 25 1 06278 06 0	44220, 44225, 44230, 44235, 44360, 44370, 44460, 44470								
	<ul style="list-style-type: none"> For lock 1.5C611.45.0.00.EN on round ABITHAL profile 	0,026 12 1 06278 07 0									

Type	Description	For series/item	Unit weight Pieces	ITEM				
				Type	Dim.	Hand	Fin.	Pers.
		44220, 44225	0,035	25	1	06278	16	0
		14460, 44120, 44360, 44460	0,033	25	1	06278	17	0
		44131, 44231, 44236, 44238, 44371, 44471	0,025	25	1	06278	19	0
		44221, 44226	0,025	25	1	06278	20	0
		14461, 44121, 44361, 44461	0,026	25	1	06278	21	0
		44131, 44231, 44236, 44238, 44371, 44471	0,035	25	1	06278	22	0

Type	Description	For series/item	Unit weight Kg	Pieces	ITEM	Type	Dim.	Hand	Fin.	Pers.	Spec.
		44219, 44221, 44224, 44226	0,017	25	1 06278 26 0						
		14461, 14462, 44121, 44361, 44362, 44461, 44462	0,022	25	1 06278 27 0						
	<p>• Use nylon roller insert item 1.06141.82.0</p>	44131, 44231, 44236, 44238, 44371, 44471	0,030	25	1 06278 28 0						
		44219, 44221, 44224, 44226	0,019	25	1 06278 64 0						
		14461, 14462, 44121, 44361, 44362, 44461, 44462	0,021	25	1 06278 65 0						
		44131, 44231, 44236, 44238, 44371, 44471	0,019	25	1 06278 66 0						

Type	Description	For series/item	Unit weight Pieces	ITEM				
				Type	Dim.	Hand	Fin.	Pers. Spec.
		14461, 14462, 44121, 44361, 44362, 44461, 44462	0,030	25	1	06278	80	0
		16205, 16215, 16225, 16425, 16625, 46215, 46225, 46425, 46435, 46445, 46625	0,025	25	1	06285	25	0
		16205, 16215, 16225, 16425, 16625, 46215, 46225, 46425, 46435, 46445, 46625	0,035	12	1	06285	27	0
	<ul style="list-style-type: none"> For roller locks item 46230 - 46250 - 46450 - 46550 - 46650 - 46750 use nylon insert item 1.06141.76.0 	16205, 16215, 16225, 16425, 16525, 16625, 16725, 46215, 46225, 46230, 46250, 46425, 46435, 46445, 46450, 46525, 46550, 46625, 46650, 46725, 46750	0,026	12	1	06285	30	0
	<ul style="list-style-type: none"> For roller locks item 46230 - 46250 - 46450 - 46550 - 46650 - 46750 use nylon insert item 1.06141.76.0 	16205, 16215, 16225, 16425, 16525, 16625, 16725, 46215, 46225, 46230, 46250, 46425, 46435, 46445, 46450, 46525, 46550, 46625, 46650, 46725, 46750	0,035	12	1	06285	32	0
	<ul style="list-style-type: none"> For roller locks item 46230 - 46250 - 46450 - 46550 - 46650 - 46750 use nylon insert item 1.06141.76.0 	16205, 16215, 16225, 16425, 16525, 16625, 16725, 46215, 46225, 46230, 46250, 46425, 46435, 46445, 46450, 46525, 46550, 46625, 46650, 46725, 46750	0,020	12	1	06285	34	0

Type	Description	For series/item	Unit weight Pieces	ITEM				
				Type	Dim.	Hand	Fin.	Pers. Spec.

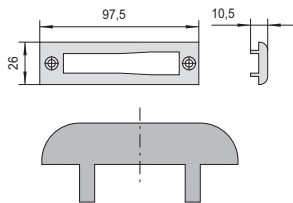

1 06443 00 0, 1 06443 05 0, 0,030 25 1 06285 35 0
 1 06453 05 0, 46200,
 46210, 46220, 46420,
 46520

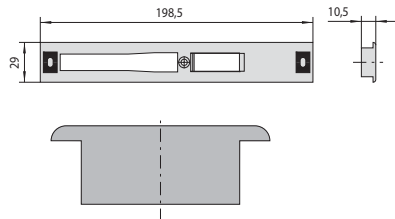

• For roller locks item 46230 - 16205, 16215, 16225,
 46250 - 46450 - 46550 - 46650 16425, 16525, 16625,
 - 46750 use nylon insert item 16725, 46215, 46225,
 1.06141.76.0 46230, 46250, 46425,
 46435, 46445, 46450,
 46525, 46550, 46625,
 46650, 46725, 46750

0,030 12 1 06285 36 0

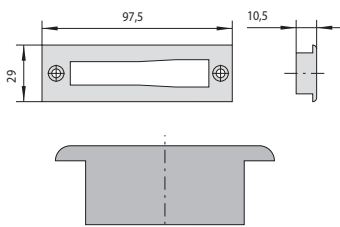

1 06443 00 0, 1 06443 05 0, 0,015 25 1 06285 37 0
 1 06453 05 0, 46200,
 46210, 46220, 46420,
 46520

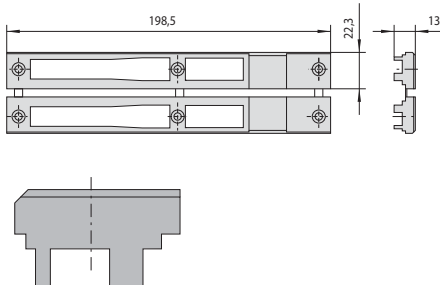

• For roller locks item 46230 - 16205, 16215, 16225,
 46250 - 46450 - 46550 - 46650 16425, 16525, 16625,
 - 46750 use nylon insert item 16725, 46215, 46225,
 1.06141.76.0 46230, 46250, 46425,
 46435, 46445, 46450,
 46525, 46550, 46625,
 46650, 46725, 46750

0,048 6 1 06285 38 0

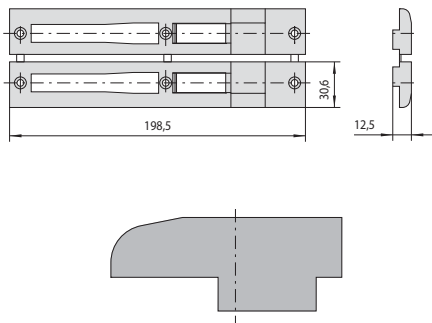

• For roller locks item 46230 - 16205, 16215, 16225,
 46250 - 46450 - 46550 - 46650 16425, 16525, 16625,
 - 46750 use nylon insert item 16725, 46215, 46225,
 1.06141.76.0 46230, 46250, 46425,
 46435, 46445, 46450,
 46525, 46550, 46625,
 46650, 46725, 46750

0,072 6 1 06285 42 0

Type	Description	For series/item	Unit weight Pieces	ITEM				
				Type	Dim.	Hand	Fin.	Pers. Spec.

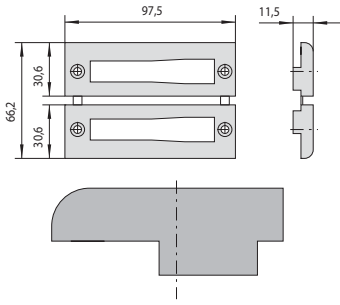

1 06443 00 0, 1 06443 05 0, 0,030 12 1 06285 43 0
 1 06453 05 0, 46200,
 46210, 46220, 46420,
 46520

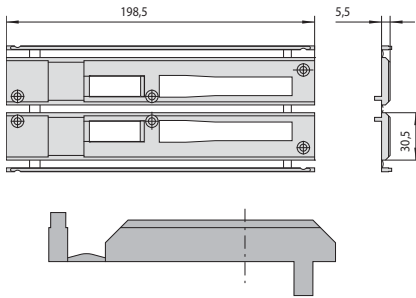

• For roller locks item 46230 - 16205, 16215, 16225,
 46250 - 46450 - 46550 - 46650 16425, 16525, 16625,
 - 46750 use nylon insert item 16725, 46215, 46225,
 1.06141.76.0 46230, 46250, 46425,
 46435, 46445, 46450,
 46525, 46550, 46625,
 46650, 46725, 46750

0,060 6 1 06285 44 0

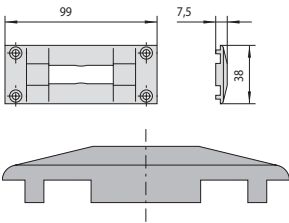

14010, 14011, 14012,
 14017, 14020, 14021,
 14350, 14351, 14450,
 14451, 14510, 14511,
 44110, 44111, 44115,
 44116, 44140, 44141,
 44145, 44146, 44150,
 44151, 44155, 44156,
 44160, 44161, 44227,
 44228, 44240, 44241,
 44245, 44246, 44350,
 44351, 44450, 44451

0,014 25 1 06287 02 0

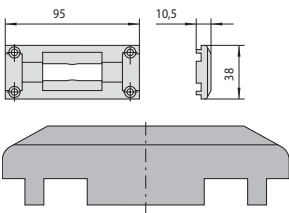

14010, 14011, 14012,
 14017, 14020, 14021,
 14350, 14351, 14450,
 14451, 14510, 14511,
 44110, 44111, 44115,
 44116, 44140, 44141,
 44145, 44146, 44150,
 44151, 44155, 44156,
 44160, 44161, 44227,
 44228, 44240, 44241,
 44245, 44246, 44350,
 44351, 44450, 44451

0,030 25 1 06287 11 0

Type	Description	For series/item	Unit weight Pieces	ITEM		
				Type	Dim. Hand	Fin. Pers. Spec.
		14011, 14012, 14017, 14020, 14350, 14450, 14510, 44110, 44115, 44140, 44145, 44150, 44155, 44160, 44227, 44240, 44245, 44350, 44450	0,016 25	1	06287	14 0
		14011, 14012, 14017, 14020, 14350, 14450, 14510, 44110, 44115, 44140, 44145, 44150, 44155, 44160, 44227, 44240, 44245, 44350, 44450	0,024 25	1	06287	17 0
		14011, 14021, 14351, 14451, 14511, 44111, 44116, 44141, 44146, 44151, 44156, 44161, 44228, 44241, 44246, 44351, 44451	0,017 25	1	06287	21 0
		14010, 14011, 14012, 14017, 14020, 14021, 14350, 14351, 14352, 14450, 14451, 14452, 14510, 14511, 14512, 44110, 44111, 44115, 44116, 44140, 44141, 44145, 44146, 44150, 44151, 44152, 44155, 44156, 44157, 44160, 44161, 44162, 44227, 44228, 44240, 44241, 44245, 44246, 44350, 44351, 44450, 44451	0,015 25	1	06287	26 0

Type	Description	For series/item	Unit weight Pieces	ITEM				
				Type	Dim.	Hand	Fin.	Pers.
		14010, 14011, 14012, 14017, 14020, 14021, 14350, 14351, 14352, 14450, 14451, 14452, 14510, 14511, 14512, 44110, 44111, 44115, 44116, 44140, 44141, 44145, 44146, 44150, 44151, 44152, 44155, 44156, 44157, 44160, 44161, 44162, 44227, 44228, 44240, 44241, 44245, 44246, 44350, 44351, 44450, 44451	0,014	25	1	06287	27	0
		14011, 14021, 14351, 14451, 14511, 44111, 44116, 44141, 44146, 44151, 44156, 44161, 44228, 44241, 44246, 44351, 44451	0,015	25	1	06287	29	0
		14011, 14021, 14351, 14352, 14451, 14452, 14511, 14512, 44111, 44116, 44141, 44146, 44151, 44152, 44156, 44157, 44161, 44162, 44228, 44241, 44246, 44351, 44451	0,030	25	1	06287	50	0
	• For roller locks item item 44670 use nylon insert item 1.06141.55.0	44620, 44621, 44625, 44626, 44630, 44635, 44640	0,022	25	1	06287	64	0
		14011, 14021, 14351, 14352, 14451, 14452, 14511, 14512, 44111, 44116, 44141, 44146, 44151, 44152, 44156, 44157, 44161, 44162, 44228, 44241, 44246, 44351, 44451	0,016	25	1	06287	65	0

Type	Description	For series/item	Unit weight Pieces	ITEM				
				Type	Dim.	Hand	Fin.	Pers. Spec.

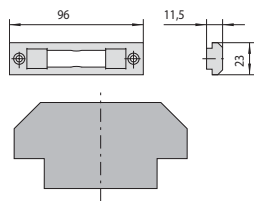

14011, 14021, 14351,
14352, 14451, 14452,
14511, 14512, 44111,
44116, 44141, 44146,
44151, 44152, 44156,
44157, 44161, 44162,
44228, 44241, 44246,
44351, 44451

0,012 25 1 06287 77 0

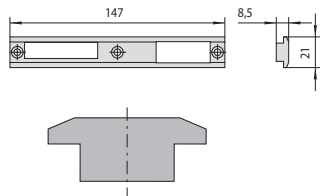

44620, 44621, 44625,
44626, 44640

0,012 25 1 06287 88 0

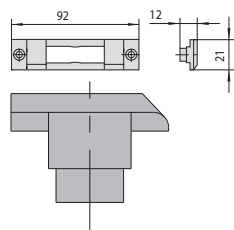

14010, 14011, 14012,
14017, 14020, 14021,
14350, 14351, 14352,
14450, 14451, 14452,
14510, 14511, 14512,
44110, 44111, 44115,
44116, 44140, 44141,
44145, 44146, 44150,
44151, 44152, 44155,
44156, 44157, 44160,
44161, 44162, 44227,
44228, 44240, 44241,
44245, 44246, 44350,
44351, 44450, 44451

0,011 25 1 06287 89 0

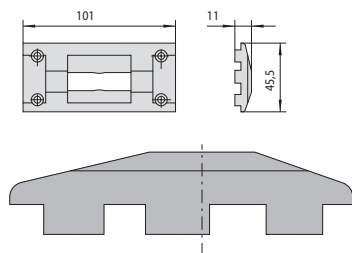

14011, 14021, 14351,
14451, 14511, 44111,
44116, 44141, 44146,
44151, 44156, 44161,
44228, 44241, 44246,
44351, 44451

0,023 25 1 06287 92 0

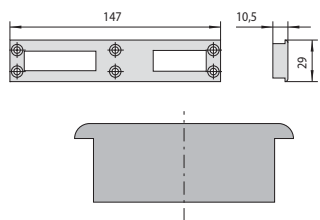

44620, 44621, 44625,
44626, 44640

0,022 25 1 06287 94 0

Type	Description	For series/item	Unit weight Kg	Pieces	ITEM			
					Type	Dim.	Hand	Fin.

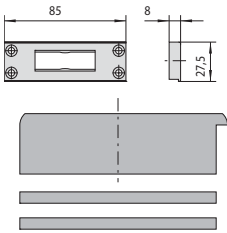

14010, 14011, 14012,
14017, 14020, 14021,
14350, 14351, 14352,
14450, 14451, 14452,
14510, 14511, 14512,
44110, 44111, 44115,
44116, 44140, 44141,
44145, 44146, 44150,
44151, 44152, 44155,
44156, 44157, 44160,
44161, 44162, 44227,
44228, 44240, 44241,
44245, 44246, 44350,
44351, 44450, 44451

0,020 25

1 06287 95 0

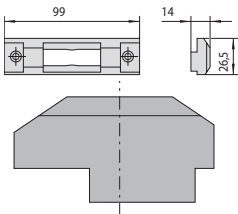

14011, 14021, 14351,
14451, 14511, 44111,
44116, 44141, 44146,
44151, 44156, 44161,
44228, 44241, 44246,
44351, 44451

0,017 25

1 06287 97 0

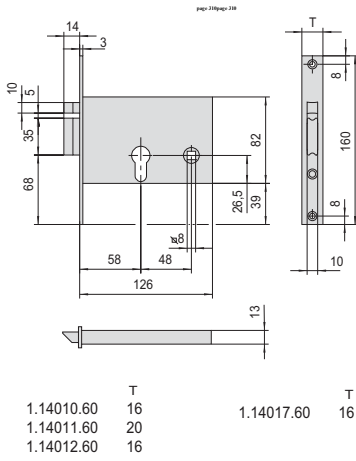

1

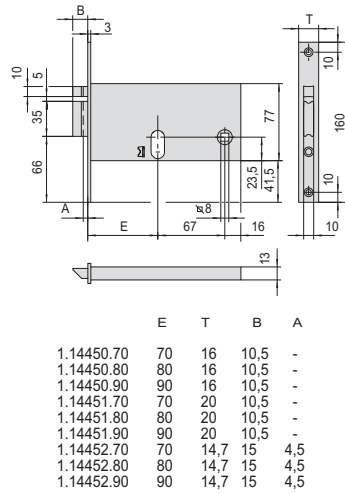

4

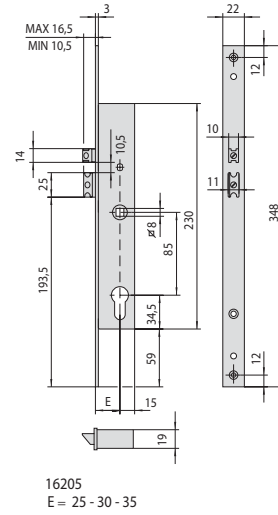

7

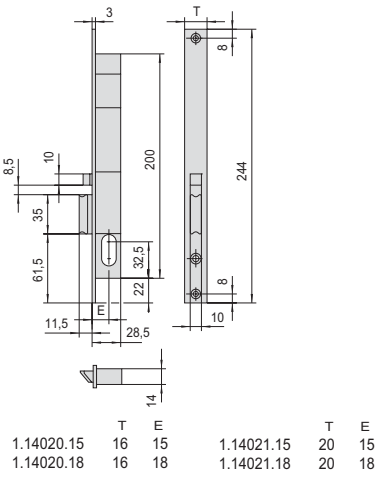

2

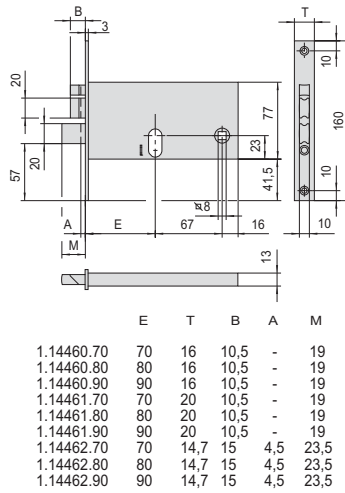

5

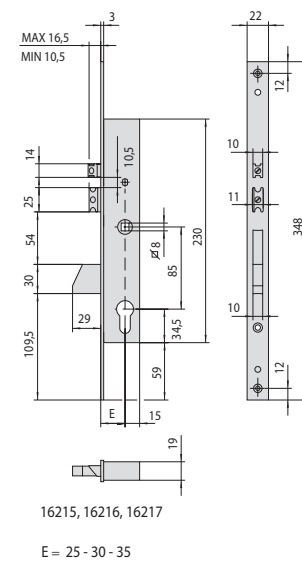

8

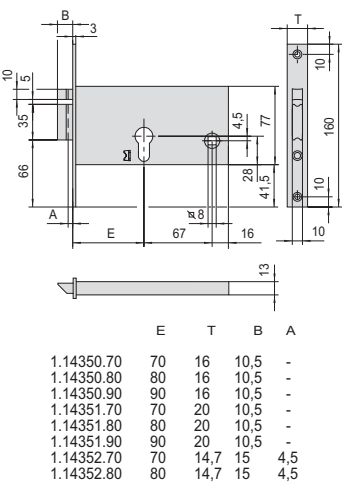

3

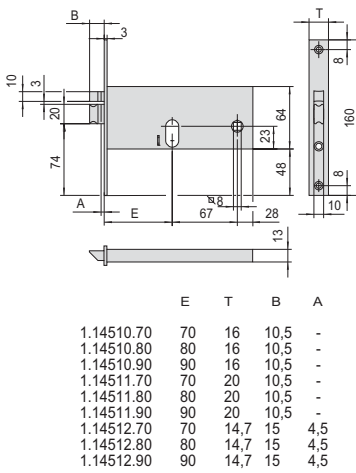

6

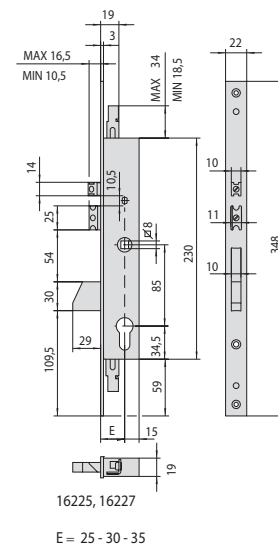

9

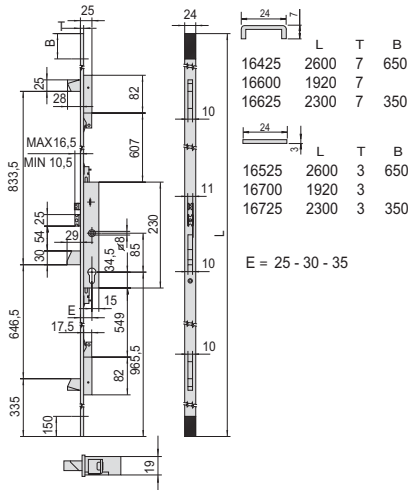

10

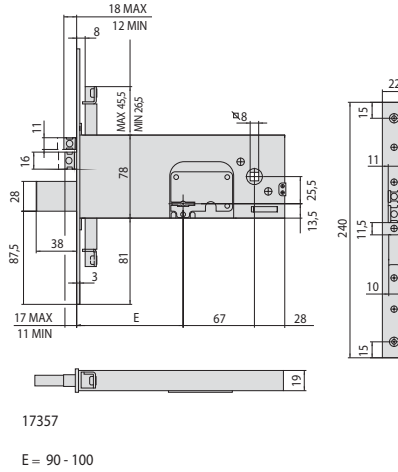

13

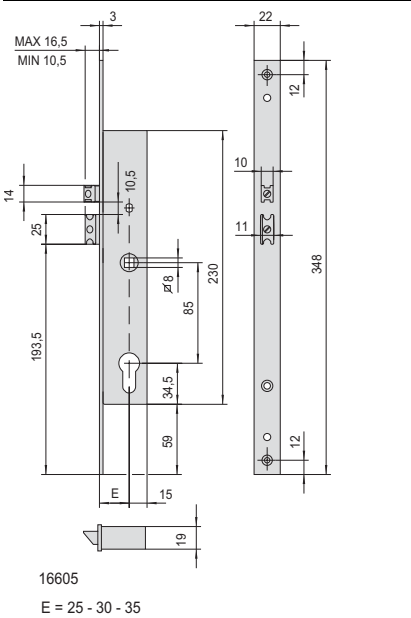

11

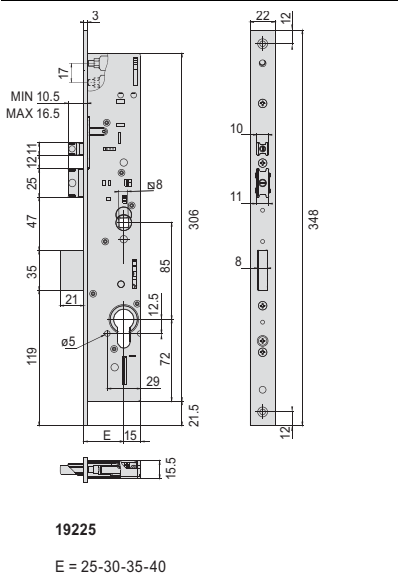

14

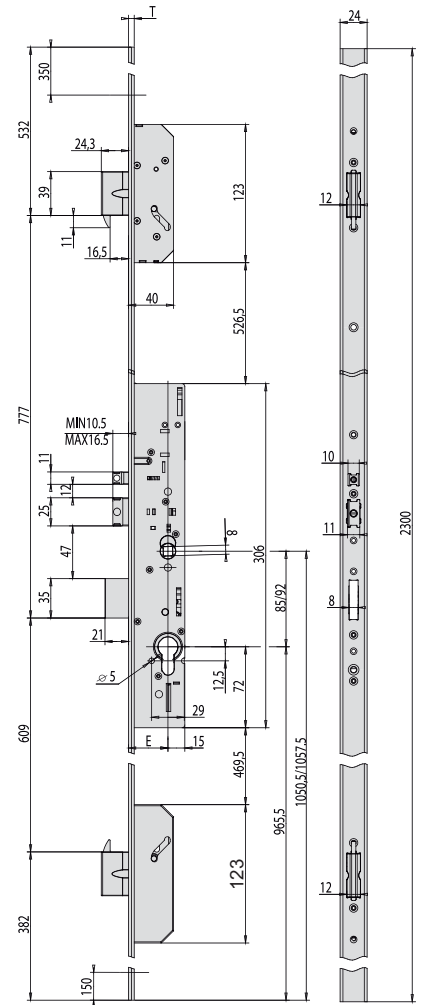

15

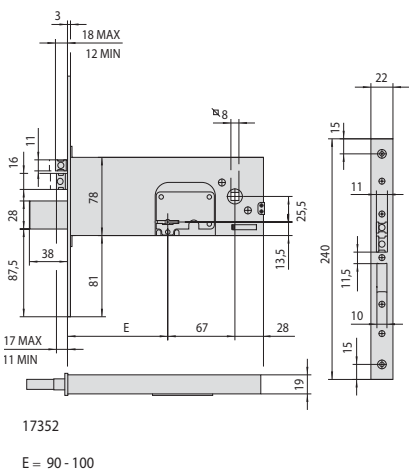

12

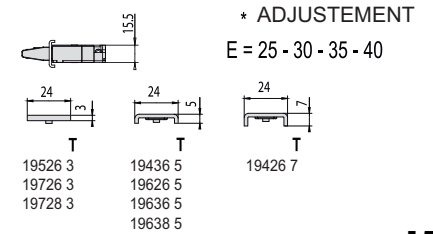

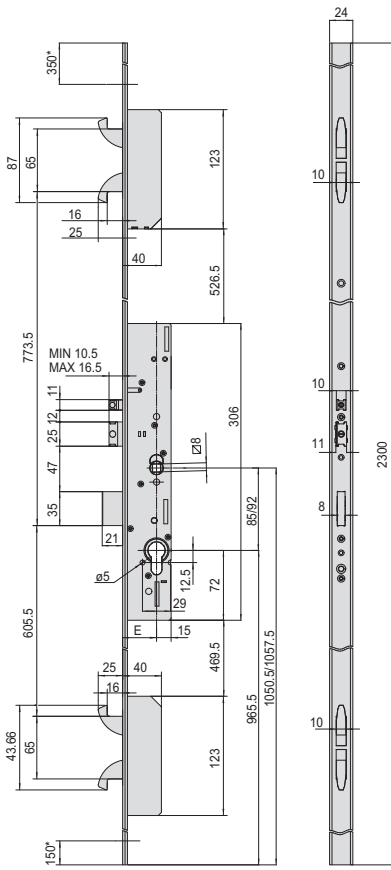

* RASABILITÀ
E = 25 - 30 - 35 - 40

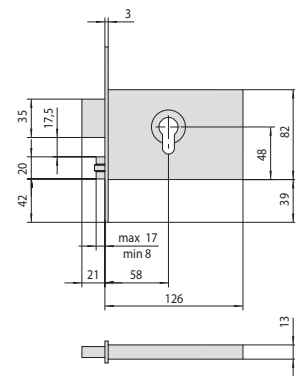

T
1.44130.60 16
1.44131.60 20

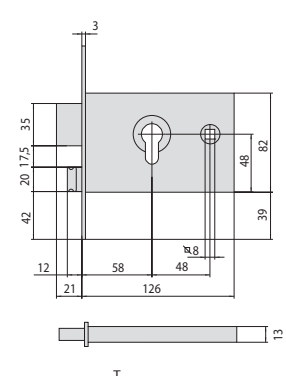
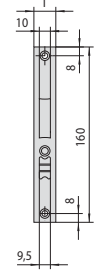

T
1.44120.60 16
1.44121.60 20

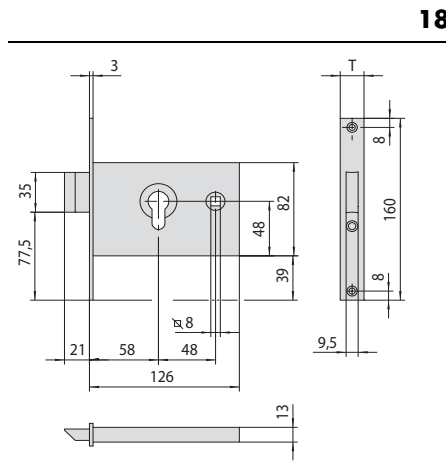
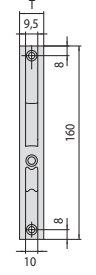

T
1.44140.60 16
1.44141.60 20

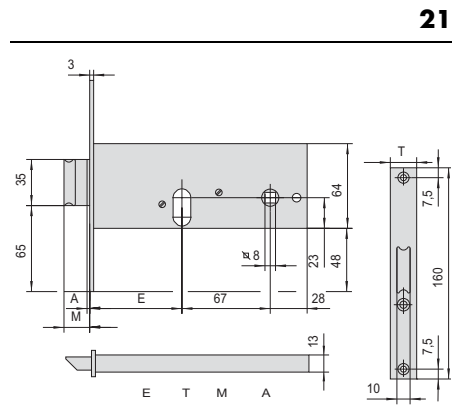
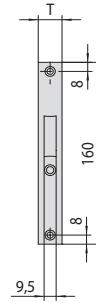

	E	T	M	A
1.44155.60	60	16	19	-
1.44155.70	70	16	28	-
1.44155.80	80	16	28	-
1.44155.90	90	16	28	-
1.44156.60	60	20	19	-
1.44156.70	70	20	28	-
1.44156.80	80	20	28	-
1.44156.90	90	20	28	-
1.44157.70	70	14,7	32,5	4,5

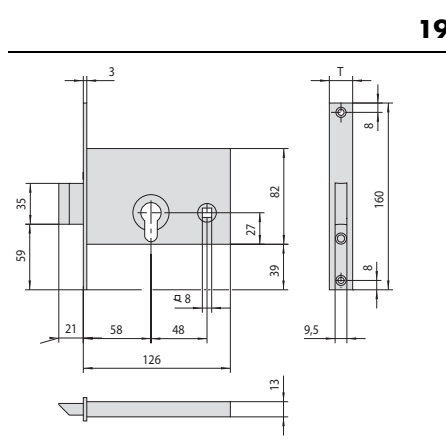

T
1.44145.60 16
1.44146.60 20

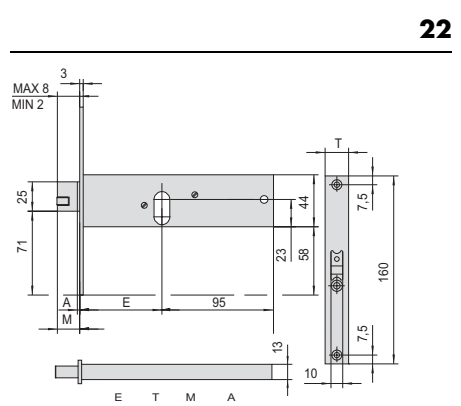
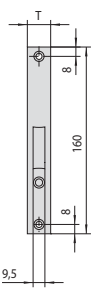

	E	T	M	A
1.44160.60	60	16	19	-
1.44160.70	70	16	28	-
1.44160.80	80	16	28	-
1.44160.90	90	16	28	-
1.44161.60	60	20	19	-
1.44161.70	70	20	28	-
1.44161.80	80	20	28	-
1.44161.90	90	20	28	-

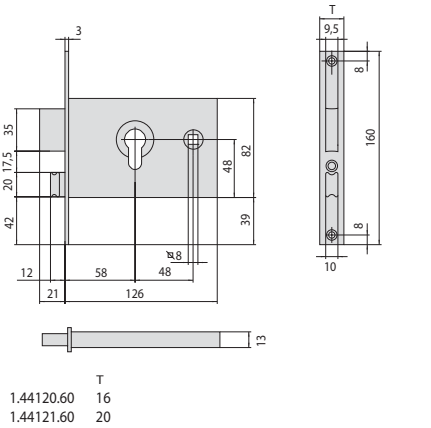

T
1.44120.60 16
1.44121.60 20

17

20

23

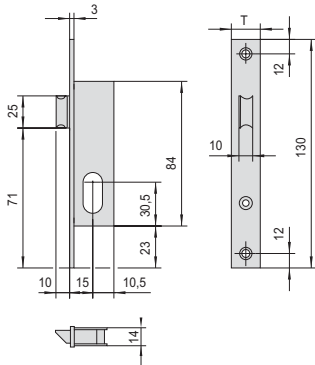

	T
1.44217.15	16
1.44218.15	20

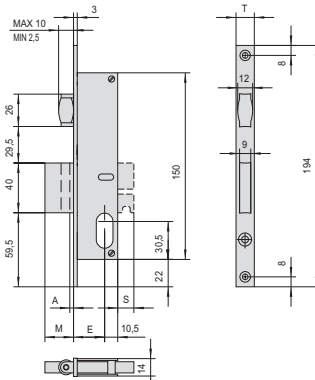

E	T	M	A	B	S	E	T	M	A	B	S		
1.44230.15	15	16	11	2	10	-	1.44235.15	15	16	18	2	10	13
1.44230.18	18	16	11	2	10	-	1.44235.18	18	16	18	2	10	13
1.44230.25	25	16	11	2	10	-	1.44235.25	25	16	18	2	10	13
1.44230.30	30	16	11	2	10	-	1.44235.30	30	16	18	2	10	13
1.44230.35	35	16	11	2	10	-	1.44235.35	35	16	18	2	10	13
1.44231.15	15	20	11	2	10	-	1.44236.15	15	20	18	2	10	13
1.44231.18	18	20	11	2	10	-	1.44236.18	18	20	18	2	10	13
1.44231.25	25	20	11	2	10	-	1.44236.25	25	20	18	2	10	13
1.44231.30	30	20	11	2	10	-	1.44236.30	30	20	18	2	10	13
1.44231.35	35	20	11	2	10	-	1.44236.35	35	20	18	2	10	13

24

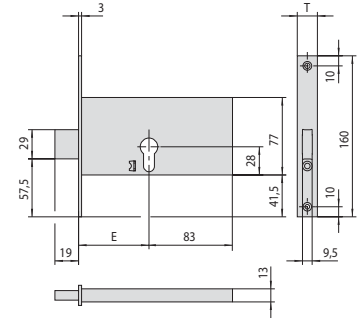

	E	T
1.44350.70	70	16
1.44351.70	70	20

30

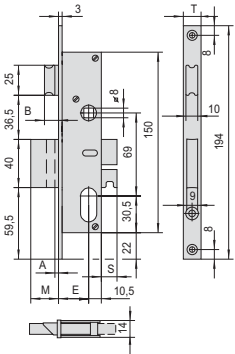

E	T	M	A	B	S	E	T	M	A	B	S		
1.44219.25	25	14,7	16	6,5	14,5	-	1.44224.25	25	14,7	23	6,5	14,5	13
1.44219.30	30	14,7	16	6,5	14,5	-	1.44224.30	30	14,7	23	6,5	14,5	13
1.44220.15	15	16	11	2	10	-	1.44225.15	15	16	18	2	10	13
1.44220.18	18	16	11	2	10	-	1.44225.18	18	16	18	2	10	13
1.44220.25	25	16	11	2	10	-	1.44225.25	25	16	18	2	10	13
1.44220.30	30	16	11	2	10	-	1.44225.30	30	16	18	2	10	13
1.44220.35	35	16	11	2	10	-	1.44225.35	35	16	18	2	10	13
1.44221.15	15	20	11	2	10	-	1.44226.15	15	20	18	2	10	13
1.44221.18	18	20	11	2	10	-	1.44226.18	18	20	18	2	10	13
1.44221.25	25	20	11	2	10	-	1.44226.25	25	20	18	2	10	13
1.44221.30	30	20	11	2	10	-	1.44226.30	30	20	18	2	10	13
1.44221.35	35	20	11	2	10	-	1.44226.35	35	20	18	2	10	13

25

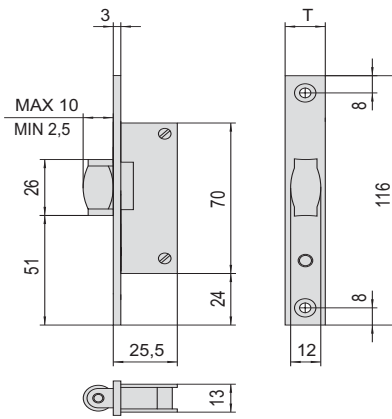

	T
1.44237.15	16
1.44238.15	20

27

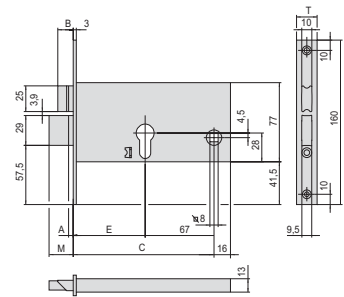

	E	T	M	A	B
1.44360.70	70	16	19	-	10,5
1.44360.80	80	16	19	-	10,5
1.44360.90	90	16	19	-	10,5
1.44361.70	70	20	19	-	10,5
1.44361.80	80	20	19	-	10,5
1.44361.90	90	20	19	-	10,5
1.44362.70	70	14,7	23,5	4,5	15
1.44362.80	80	14,7	23,5	4,5	15
1.44362.90	90	14,7	23,5	4,5	15

28

31

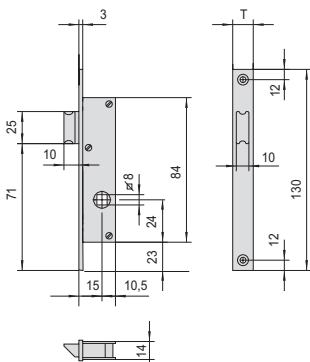

ARTICOLO	T
1.44227.15	16
1.44228.15	20

26

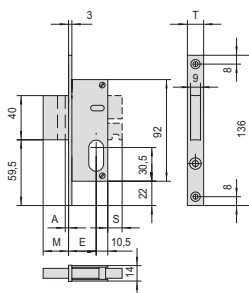

E	T	M	A	B	S	E	T	M	A	B	S		
1.44240.15	15	16	11	2	10	-	1.44245.15	15	16	18	2	10	13
1.44240.18	18	16	11	2	10	-	1.44245.18	18	16	18	2	10	13
1.44240.25	25	16	11	2	10	-	1.44245.25	25	16	18	2	10	13
1.44240.30	30	16	11	2	10	-	1.44245.30	30	16	18	2	10	13
1.44240.35	35	16	11	2	10	-	1.44245.35	35	16	18	2	10	13
1.44241.15	15	20	11	2	10	-	1.44246.15	15	20	18	2	10	13
1.44241.18	18	20	11	2	10	-	1.44246.18	18	20	18	2	10	13
1.44241.25	25	20	11	2	10	-	1.44246.25	25	20	18	2	10	13
1.44241.30	30	20	11	2	10	-	1.44246.30	30	20	18	2	10	13
1.44241.35	35	20	11	2	10	-	1.44246.35	35	20	18	2	10	13
1.44242.15	15	20	11	-	10	-	-	-	-	-	-	-	-

29

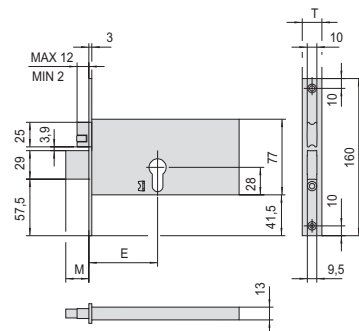

	E	T	M
1.44370.70	70	16	19
1.44370.80	80	16	19
1.44370.90	90	16	19
1.44371.70	70	20	19
1.44371.80	80	20	19
1.44371.90	90	20	19

32

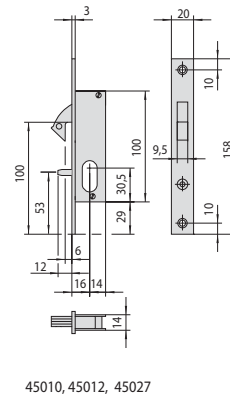
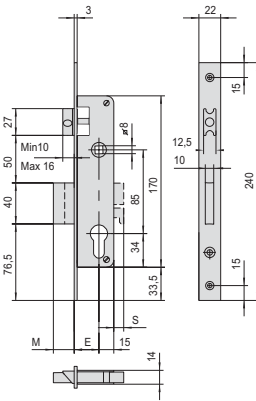
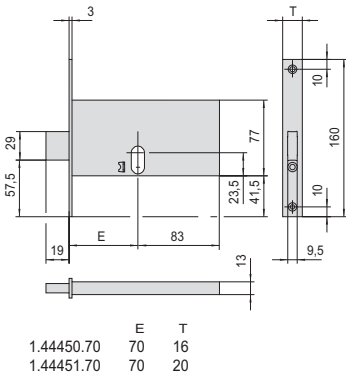

33

36

39

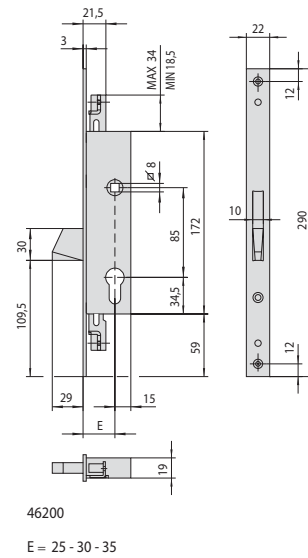
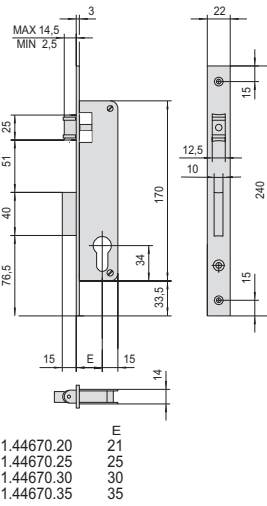
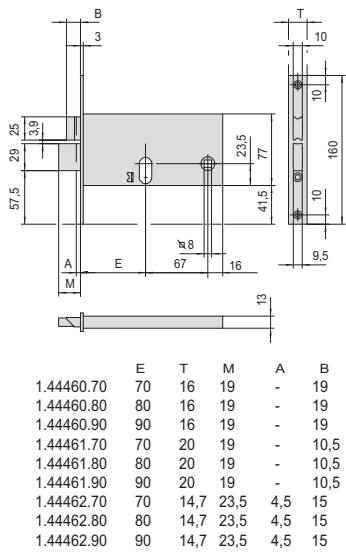

34

37

40

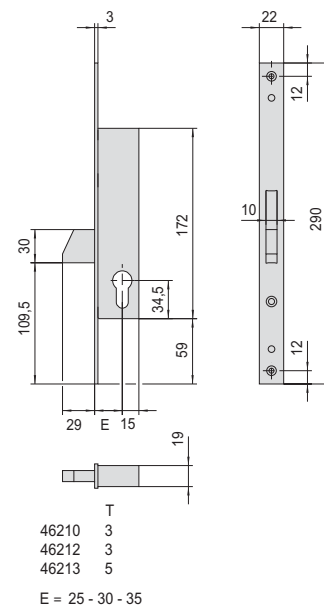
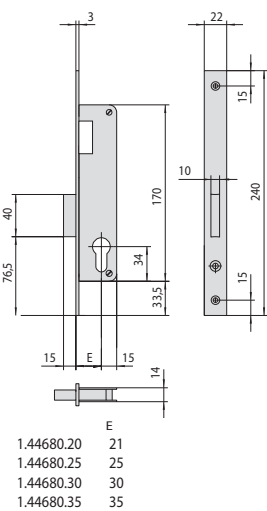
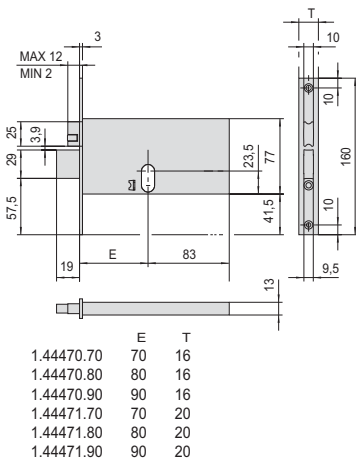

35

38

41

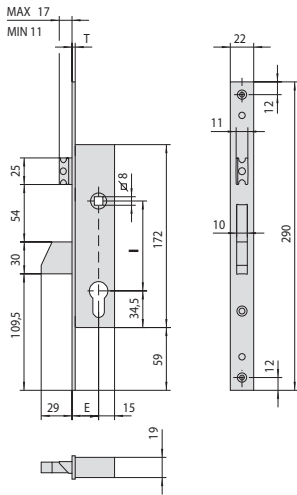

I	T
46215	85 3
46217	85 3
46218	92 5
46219	92 3

E = 25 - 30 - 35

42

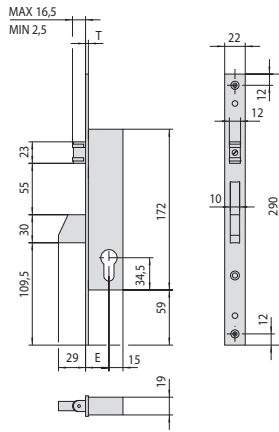

T	
46230	3
46233	5

E = 25 - 30 - 35

45

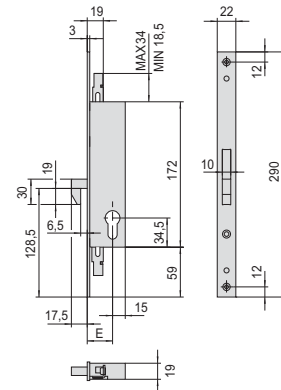

46260, 46262
E = 25 - 30 - 35

48

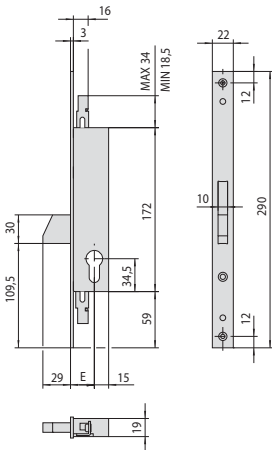

46220, 46222
E = 25 - 30 - 35

43

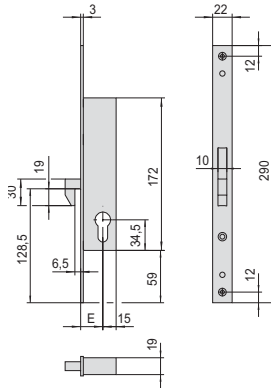

46240
E = 25 - 30 - 35

46

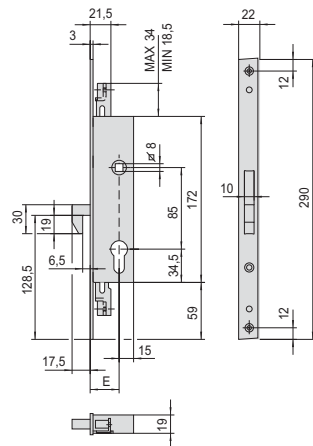

46265
E = 25 - 30 - 35

49

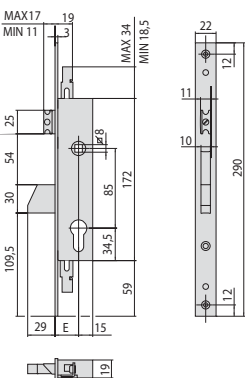

46225, 46227
E = 25 - 30 - 35

44

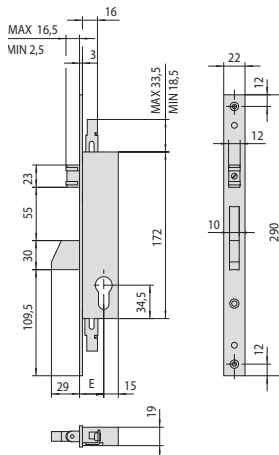

46250, 46252
E = 25 - 30 - 35

47

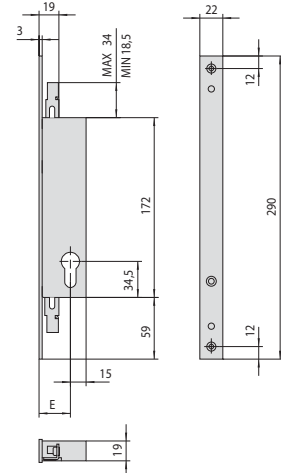

46270
E = 25 - 30 - 35

50

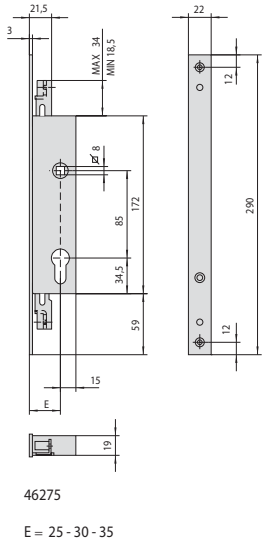

46275
E = 25 - 30 - 35

51

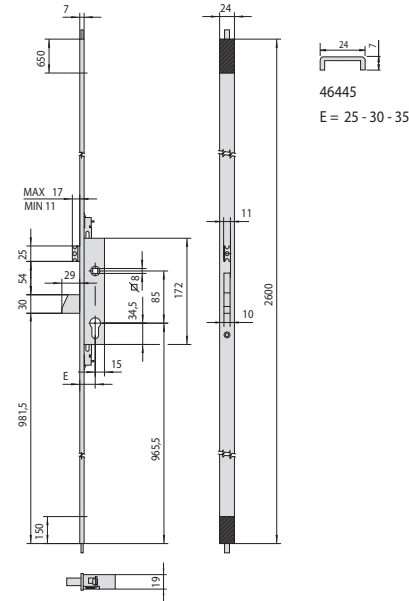

46445
E = 25 - 30 - 35

54

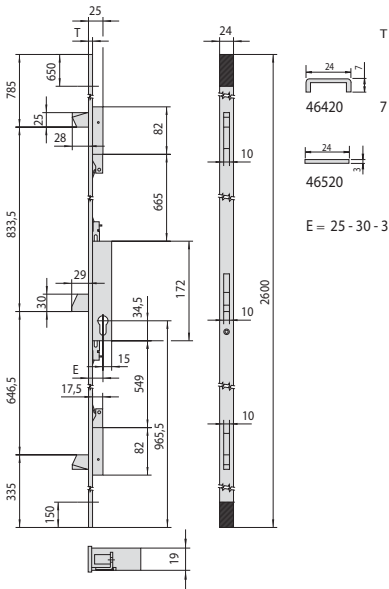

	L	T	B
46420	7	7	650
46520	3	3	650

E = 25 - 30 - 35

52

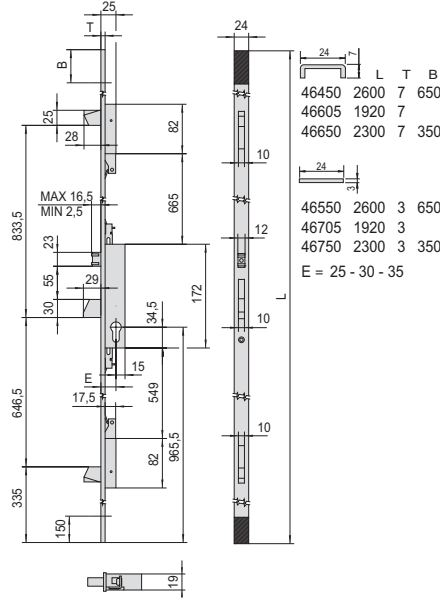

	L	T	B
46450	2600	7	650
46605	1920	7	650
46650	2300	7	350
46550	2600	3	650
46705	1920	3	650
46750	2300	3	350

E = 25 - 30 - 35

55

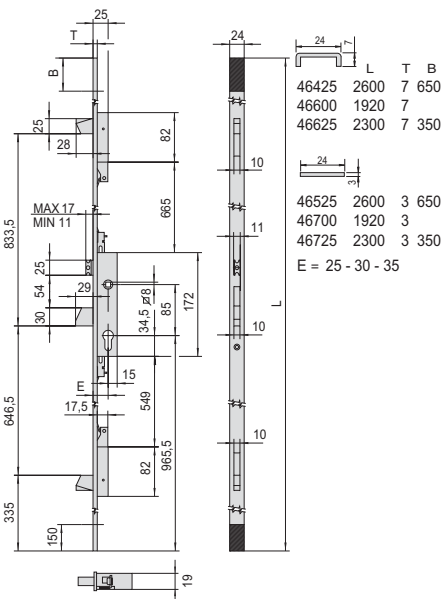

	L	T	B
46425	2600	7	650
46600	1920	7	650
46625	2300	7	350
46525	2600	3	650
46700	1920	3	650
46725	2300	3	350

E = 25 - 30 - 35

53

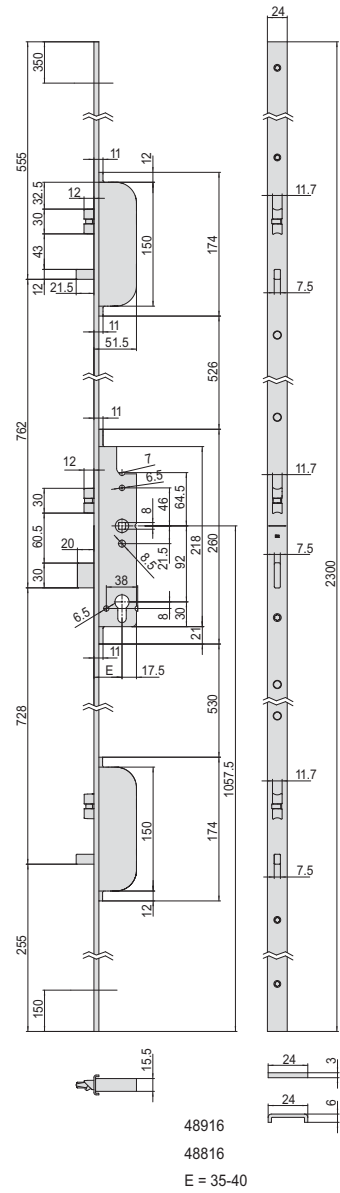

48916
48816
E = 35-40

56

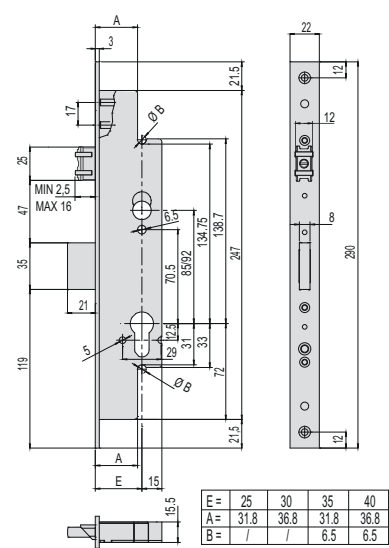

E =	25	30	35	40
A =	31.8	36.8	31.8	36.8
B =	/	/	6.5	6.5

49225, 49228

57

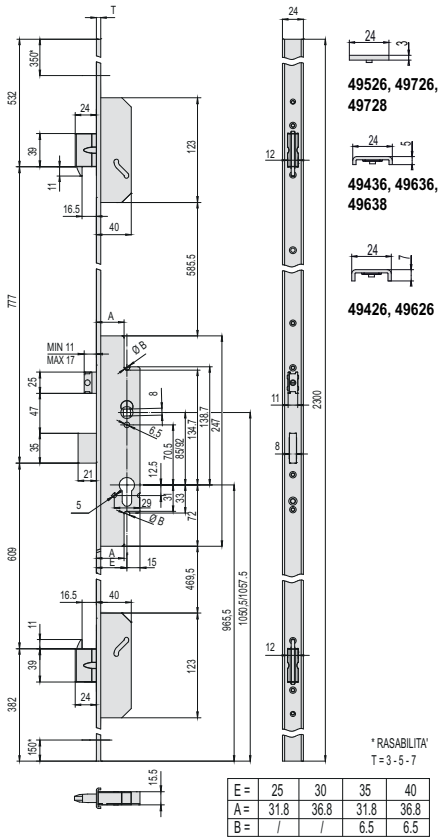

58

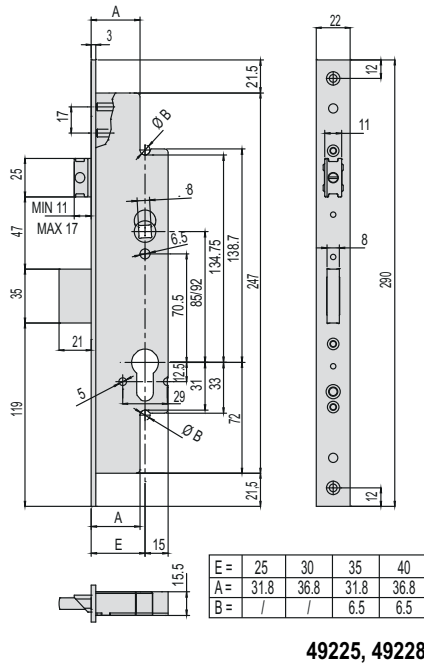

59

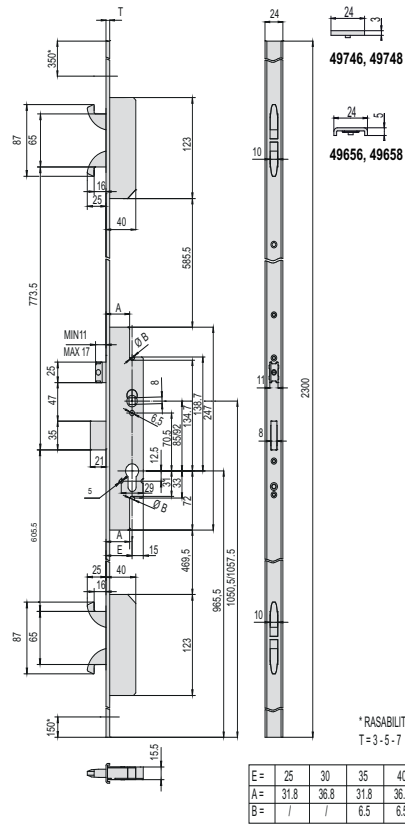

60

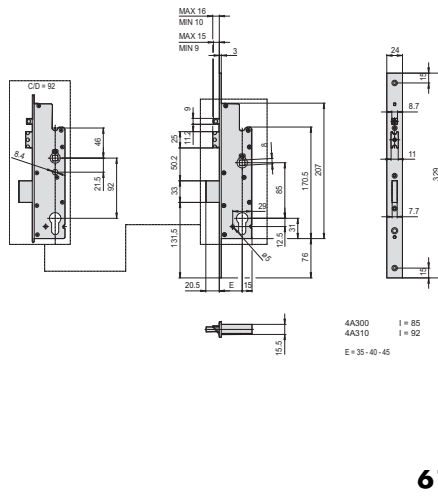

61

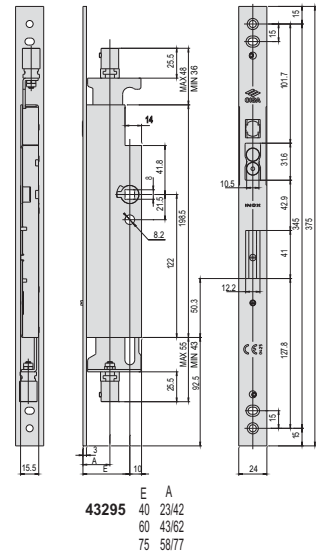

62

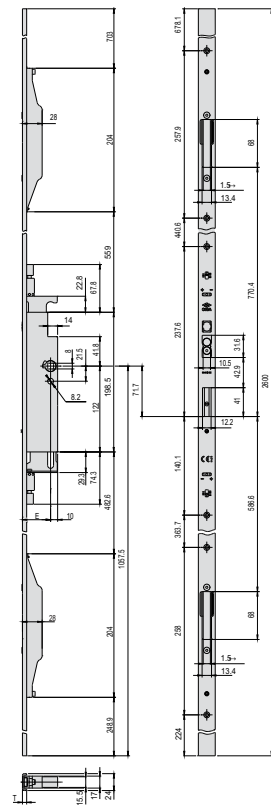

E = 40-60-75

63

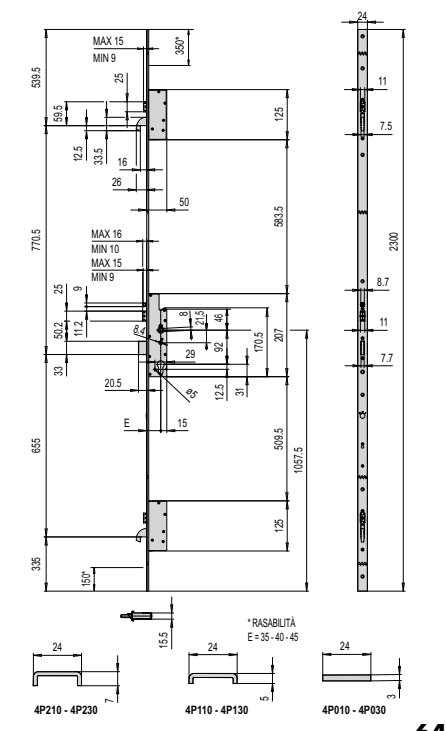

67

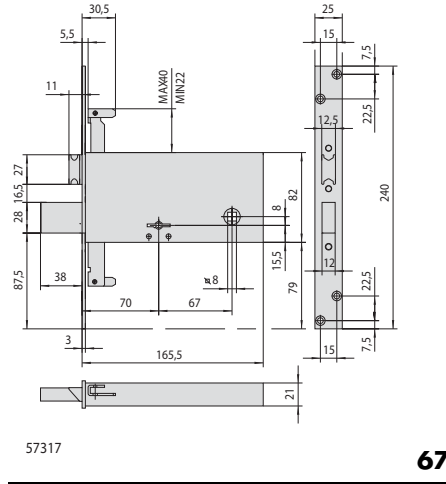

68

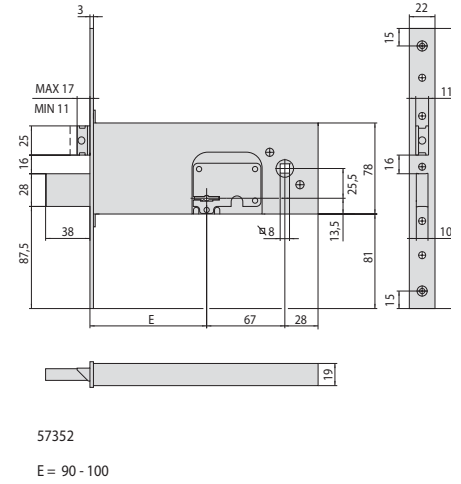

71

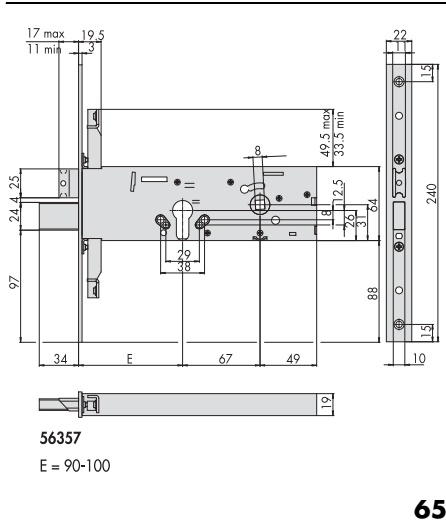

65

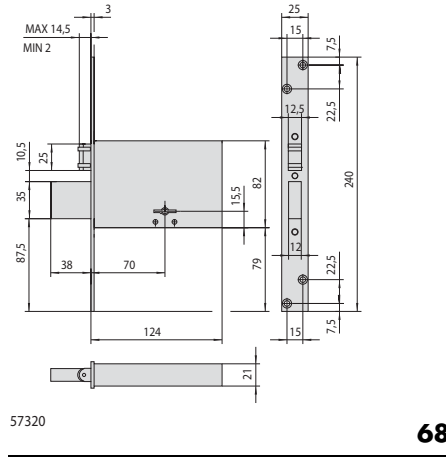

69

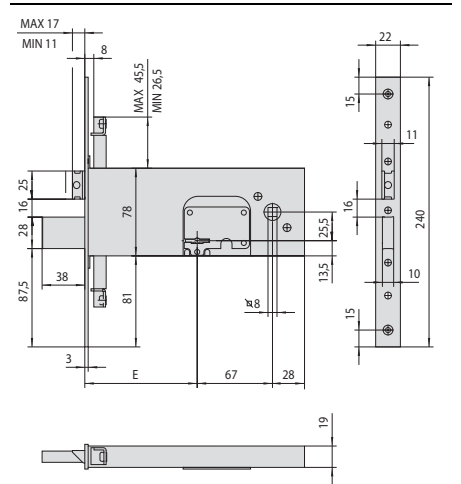

72

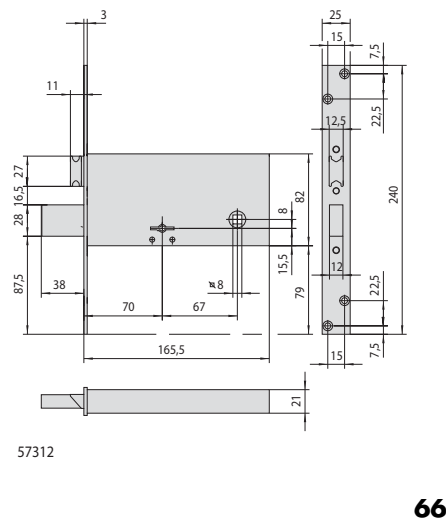

66

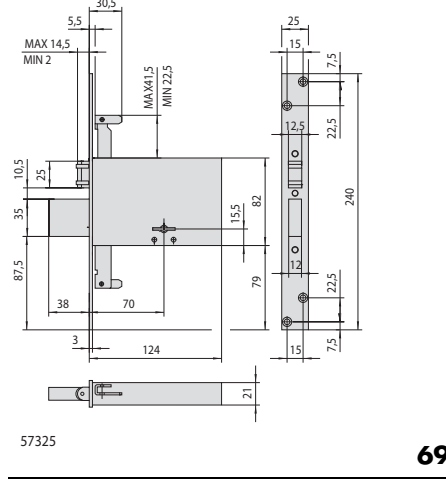

70

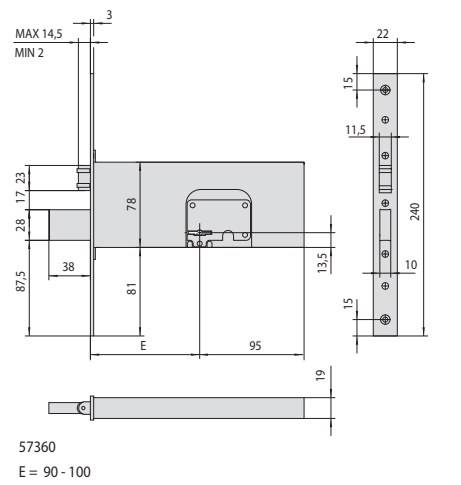

73



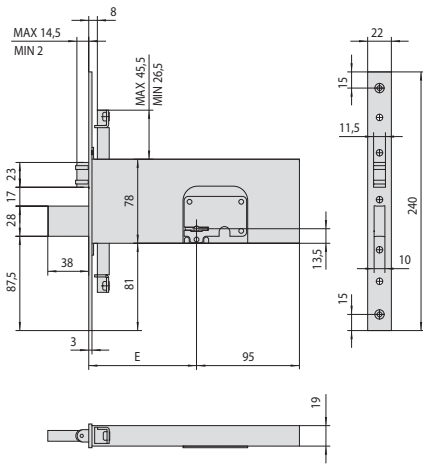

57365
E = 90 - 100

74

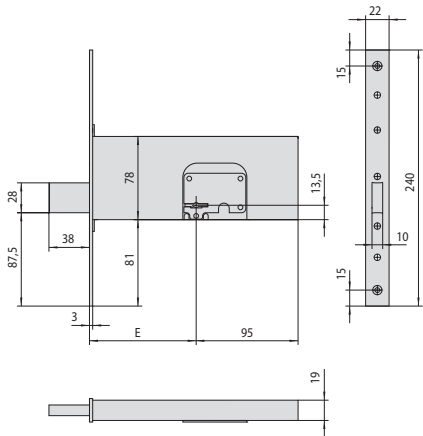

57370
E = 90 - 100

75

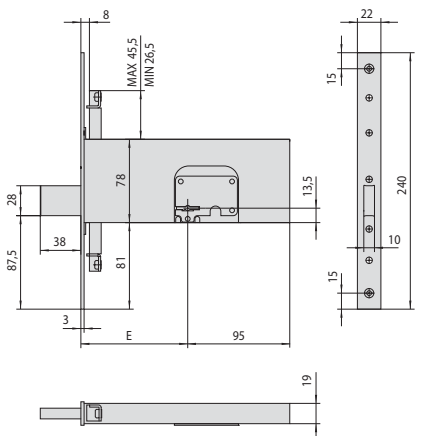

57375
E = 90 - 100

76

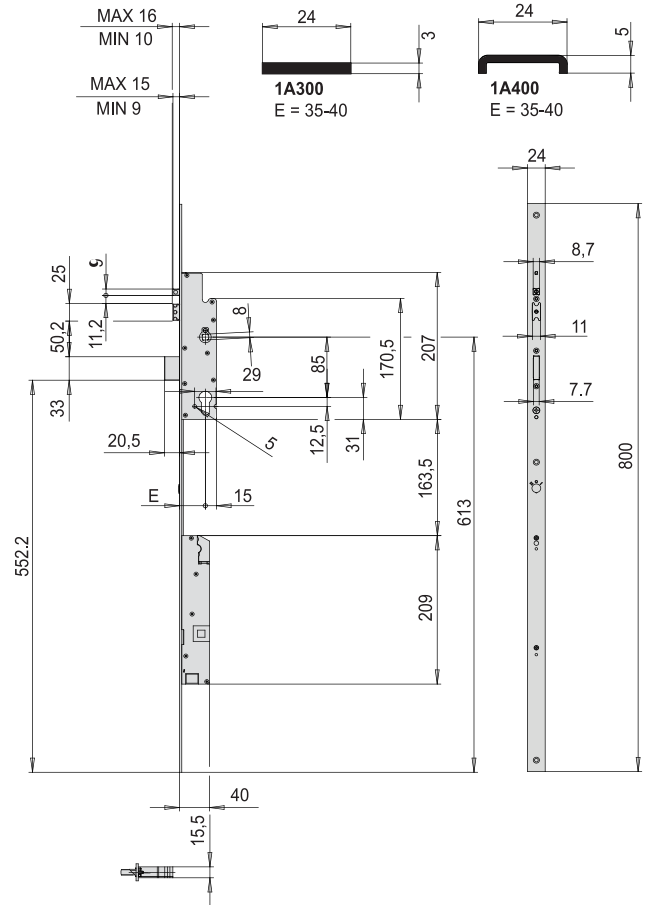

77

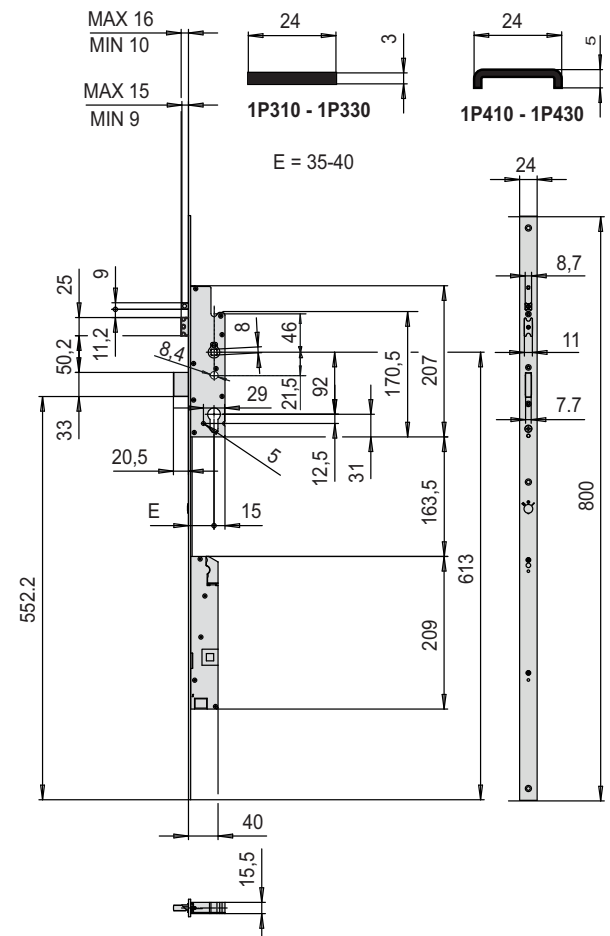

78

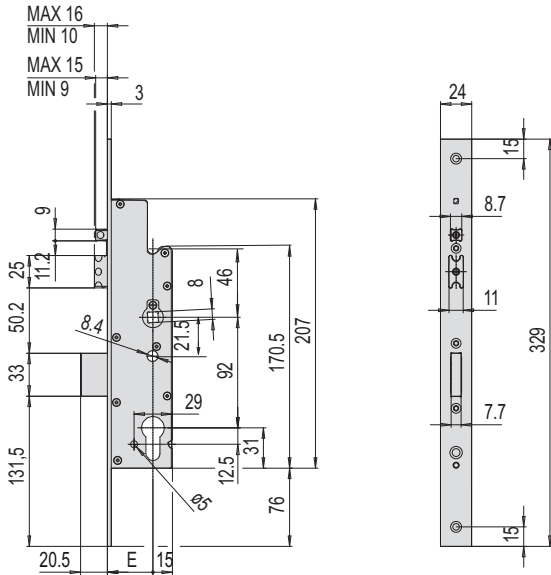

4P310 - 4P330
E = 35 - 40 - 45

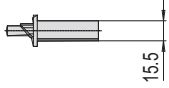

79

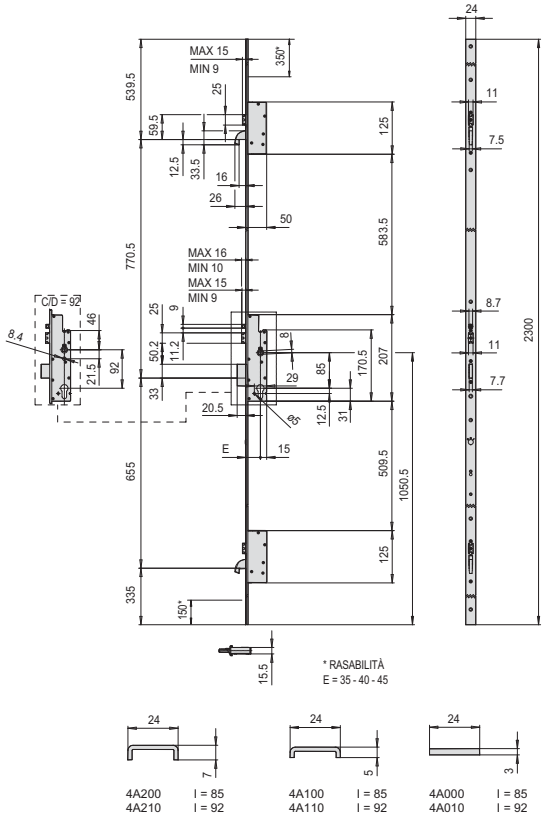

*RASABILITÀ
E = 35 - 40 - 45

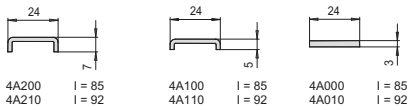

80

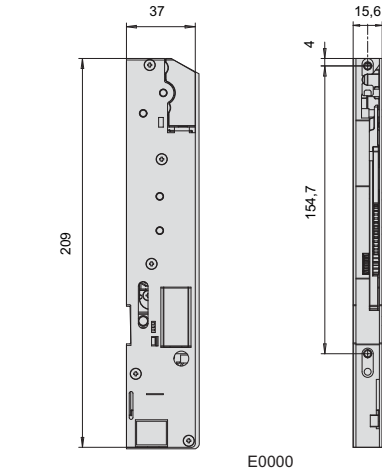

E0000

81

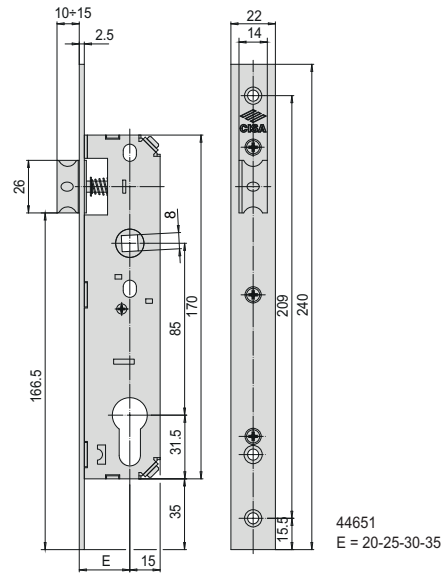

44651
E = 20-25-30-35

82

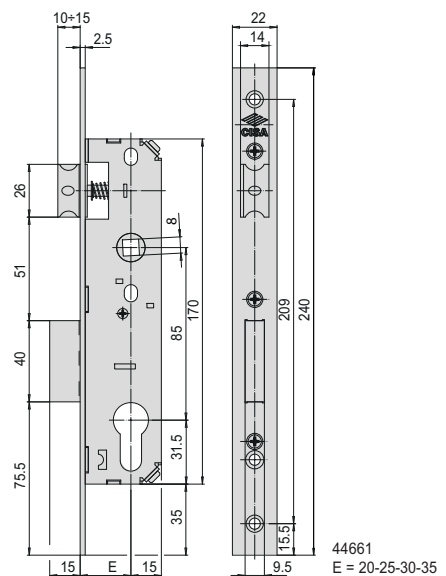

44661
E = 20-25-30-35

83

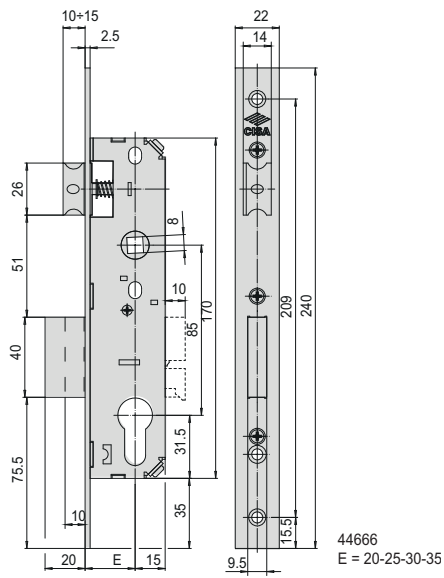

84

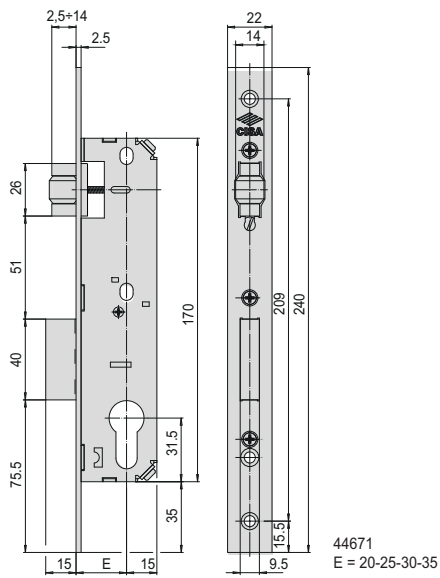

85

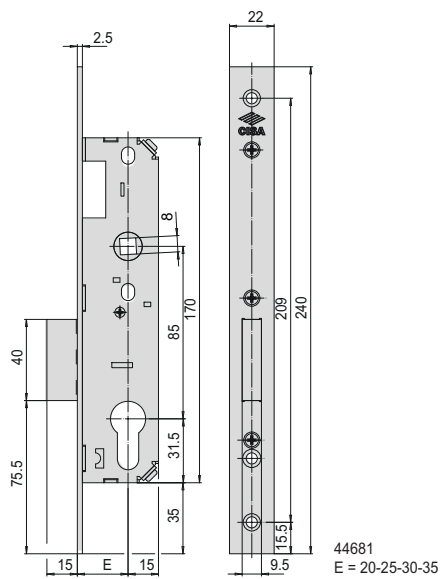

86



Locks for wooden doors



Cylinder electric rim locks - Elettrika	317	Four-throw double-bit key mortice locks with multiple deadbolt	344
Cylinder electric rim locks	318	Two-throw double-bit key mortice locks	346
Electric rim locks for heavy doors	320	Two-throw double-bit key mortice locks with multiple deadbolt	348
Electric mortice locks	321	Rim locks	349
Electric strikers for mortice locks	322	Double-bit key rim locks	351
Electric striker for mortice locks	325	Multipoint cylinder mortice locks	353
Cylinder rim locks	326	Multipoint double-bit key mortice locks	358
Multithrow cylinder rim locks	329	Project Line handles	361
Cylinder mortice locks	330	Accessories for electric locks	363
Cylinder mortice locks CISA Logo Line series	332	Accessories for cylinder rim locks	366
Cylinder mortice locks	333	Accessories for cylinder mortice locks	367
Three-throw cylinder mortice locks	334	Accessories for double-bit key mortice locks	370
Cylinder mortice locks with multiple deadbolt	336	Accessories for Heavy Duty mortice locks	374
Heavy Duty cylinder mortice locks	337	Accessories for double-bit key rim locks	375
Cylinder mortice locks	341	Accessories for multipoint mortice locks	377
Four-throw double-bit key or twin double-bit key mortice locks	342	Dimensional drawing	384

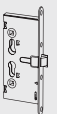
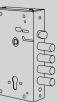



Project Line

DESIGN HANDLES FOR SPECIAL PLACES

CISA Project Line handles and protective roses: introducing design into the workplace. CISA chose handles from the Project Line range for its new offices in Faenza, because attention to detail and stylish design are just as important in the workplace as anywhere else. As always, it is the details that make the difference.

Features and functions

- Handles and protective roses in satin-finished AISI 304 stainless steel.
- Handle levers pre-mounted on mechanism with return spring.
- Fixed directly or using through screws on 38 to 54 mm thick doors. Fixing screws and square spindle provided.
- Steel fixing base with high-resistance galvanising specifically for external applications (versions with oval protective rose only).

HANDLES



Pair of handles
item 1 07070 70 0

PL Oval



Pair of handles
item 1 07070 80 0

PL Oval



Pair of handles
item 1 07070 71 0

PL Angle



Pair of handles
item 07070 82 0

PL Angle



Pair of handles
item 1 07070 73 0

PL Radius



Pair of handles
item 1 07070 81 0

PL Radius



Pair of handles
item 1 07070 72 0

PL Arcus

ROSES



Pair of protective roses for Euro profile cylinders
item 1 06093 00 0



Pair of solid protective roses
item 1 06093 01 0



Pair of protective roses for Patent locks or similar
item 1 06093 02 0



Thumb turn for bathroom doors
item 1 06093 10 0



Thumb turn for bathroom doors with vacant/engaged indicator
item 1 06093 11 0



Pair of protective roses for Euro profile cylinders
item 1 06093 04 0

Certifications

- Grade 3 – category of use (in places with high frequency of use).
- EN1906 - Grade 7 durability (200,000 cycles).
- EN1670 - Grade 2 corrosion resistance – 96 hours.
- EN1634 – Fire resistance - 2 hours on wooden doors and 4 hours on metal doors.



Technical features:

- Painted protective steel case
- Metal striker with stainless steel swinging pin
- Rotary hook deadbolt in extruded aluminium
- 12 V ac
- Non-handed and with a variable backset from 50 to 80 mm
- Rated current 3A

Supplied as standard:

- Striker
- Instruction sheet
- Fixing screws
- 2 spacers for the striker
- 3 keys item 1.01070.10.1

On request:

- Booster item 1.07022.00.0
- Booster plus item 1.07022.10.0
- BTicino coil item 1.07025.10.0
- Microswitch item 1.07023.00.0
- Open door indicator item 1.07126.01.0

Standards:

- ELETTRIKA is certified according to the European standard EN 14846:08

| 3 | X | 2 | 0 | 0 | M | 6 | 0 | 2 |

Security degree 6
(2,000 Kg lateral thrust)

Hand:
0 = Non-handed

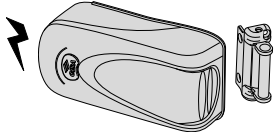
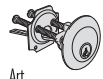
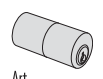
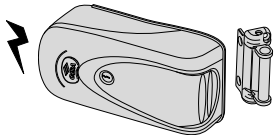
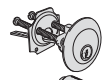
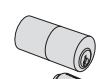

Elettrika

Type	Description	Cylinder	Throws	Backset	Unit weight Kg	Pieces	ITEM				
							Type	Dim.	Hand	Fin.	Pers.
 <ul style="list-style-type: none"> • Inner push-button 		 Art. 1 06500 00 0	50-80	2,450	1	1	1A610 00 0				
	• Version with Booster item 1.07022.10.0		50-80	2,450	1	1	1A610 00 0 00 PC				
		 Art. 1 06200 55 0	50-80	2,350	1	1	1A611 00 0				
 <ul style="list-style-type: none"> • Inner push-button • Hold open device • Brass rose 		 Art. 1 06115 00 0	50-80	2,500	1	1	1A630 00 0				
		 Art. 1 06150 00 0	50-80	2,350	1	1	1A631 00 0				



Technical features:

- Steel case and striker, painted aluminium grey
- Dead-locking latch
- Variable backset from 50 to 80 mm
- External cylinder length 55 mm, nickel plated
- 12 V ac
- Rated current 2,5A

Supplied as standard:

- Striker
- 3 keys item 1.01070.10.1
- Fixing screws
- Instruction sheet

On request:

- Booster module item 1.07022.00.0

Standards:

- This electric lock series is certified according to the European standard EN 14846:08:

| 3 | C | 2 | 0 | 0 | M | 3 | 0 | 2 |

- Security degree 3
(500 Kg lateral thrust and 200 Kg front load)

Hand:

- 1 = R.H. inwards
- 2 = L.H. inwards
- 3 = R.H. outwards
- 4 = L.H. outwards

Type	Description	Cylinder	Throws	Backset	Unit weight 	Pieces 	ITEM				
							Type	Dim.	Hand	Fin.	Pers. Spec.

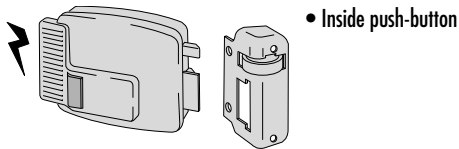

• Inside push-button



Art. 1 0G500 00 0 12

50	1,150	1	1	11610 50 1 N7
50	1,150	1	1	11610 50 2 N7
60	1,150	1	1	11610 60 1 N7
60	1,150	1	1	11610 60 2 N7
70	1,150	1	1	11610 70 1 N7
70	1,150	1	1	11610 70 2 N7
80	1,150	1	1	11610 80 1 N7
80	1,150	1	1	11610 80 2 N7

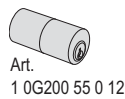

Art. 1 0G200 55 0 12

50	1,440	1	1	11611 50 1 N7
50	1,440	1	1	11611 50 2 N7
60	1,440	1	1	11611 60 1 N7
60	1,440	1	1	11611 60 2 N7
70	1,440	1	1	11611 70 1 N7
70	1,440	1	1	11611 70 2 N7
80	1,440	1	1	11611 80 1 N7
80	1,440	1	1	11611 80 2 N7

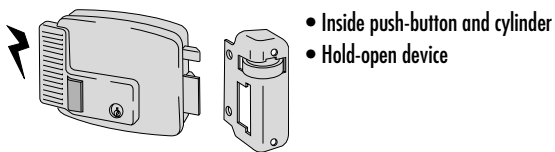

• Inside push-button and cylinder
• Hold-open device





Art. 1 02104 00 0 12

50	1,530	1	1	11630 50 1 N7
50	1,530	1	1	11630 50 2 N7
60	1,530	1	1	11630 60 1 N7
60	1,530	1	1	11630 60 2 N7
70	1,530	1	1	11630 70 1 N7
70	1,530	1	1	11630 70 2 N7
80	1,530	1	1	11630 80 1 N7
80	1,530	1	1	11630 80 2 N7

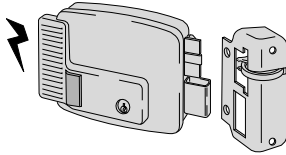

Art. 1 02110 00 0 12

50	1,530	1	1	11631 50 1 N7
50	1,530	1	1	11631 50 2 N7
60	1,530	1	1	11631 60 1 N7
60	1,530	1	1	11631 60 2 N7
70	1,530	1	1	11631 70 1 N7
70	1,530	1	1	11631 70 2 N7

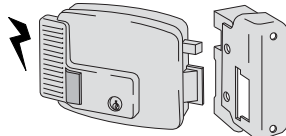
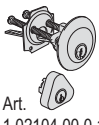
Type	Description	Cylinder	Throws	Backset	Unit weight Kg	Pieces	ITEM						
							Type	Dim.	Hand	Fin.	Pers.	Spec.	
 <ul style="list-style-type: none"> • Inside push-button and cylinder • Double throw dead-bolt 		 1 02146 00 0 12	2	50	1,650	1	1	11670	50	1	N7		
			2	50	1,650	1	1	11670	50	2	N7		
			2	60	1,650	1	1	11670	60	1	N7		
			2	60	1,650	1	1	11670	60	2	N7		
			2	70	1,650	1	1	11670	70	1	N7		
			2	70	1,650	1	1	11670	70	2	N7		
			2	70	1,750	1	1	11671	70	1	N7		
			2	70	1,750	1	1	11671	70	2	N7		
			 <ul style="list-style-type: none"> • FOR OUTWARD OPENING DOORS • Inside push-button • Hold-open device 		 Art. 1 02104 00 0 12	50	1,530	1	1	11630	50	3	N7
						50	1,530	1	1	11630	50	4	N7
60	1,530	1				1	11630	60	3	N7			
60	1,530	1				1	11630	60	4	N7			
70	1,530	1				1	11630	70	3	N7			
70	1,530	1				1	11630	70	4	N7			
80	1,530	1				1	11630	80	3	N7			
80	1,530	1				1	11630	80	4	N7			



Technical features:

- Steel case and striker, painted semi-opaque black
- Inside knob
- 12 V ac
- Rated current 0,81 A

Hand:

- 1 = R.H. inwards
- 2 = L.H. inwards

Supplied as standard:

- Striker
- 3 keys item 1.01210.00.2
- Fixing screws
- Instruction sheet

Type	Description	Cylinder	Throws	Backset	Unit weight	Pieces	ITEM			
							Type	Dim.	Hand	Fin.

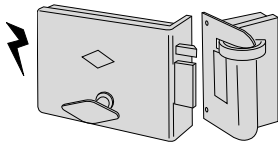

- Inside knob
- Black painted, semi-opaque

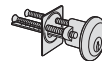

1 02520 00 0

60	3,345	1	1	13010 60 1					
60	3,350	1	1	13010 60 2					
70	3,338	1	1	13010 70 1					
70	3,314	1	1	13010 70 2					
80	3,320	1	1	13010 80 1					
80	3,322	1	1	13010 80 2					
90	3,300	1	1	13010 90 1					
90	3,286	1	1	13010 90 2					
100	3,334	1	1	13010 10 1					
100	3,322	1	1	13010 10 2					
110	3,574	1	1	13010 11 1					
110	3,260	1	1	13010 11 2					
120	3,600	1	1	13010 12 1					
120	3,260	1	1	13010 12 2					



Technical features:

- Zinc-plated steel case
- Satin brass faceplate and striker
- Reversible, electric latch
- 12 V ac
- Rated current 2,8 A

Hand:

0 = Non-handed

Cylinder to be ordered separately



Supplied as standard:

- Electric contacts 1.06510.00.0
- Striker
- Lock and cylinder fixing screws
- Instruction sheet

On request:

- Satin nickel-plated brass (fin. 12)

Type	Description	Throws	Centre Distance	Faceplate	Backset	Unit weight Kg	Pieces	ITEM			
								Type	Dim.	Hand	Fin.

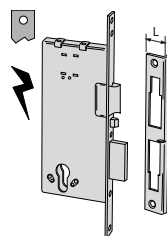

- Manual latch and deadbolt
- SUPPLIED AS STANDARD:
striker item 1.06035.00.0 (L=25 mm.)

2	22	40	0,997	1	1	12010	40	0			
2	22	50	1,040	1	1	12010	50	0			
2	22	60	1,130	1	1	12010	60	0			
2	22	70	1,138	1	1	12010	70	0			

- Manual latch and deadbolt
- SUPPLIED AS STANDARD:
striker item 1.06218.00.0 (L=37 mm.)

2	22	40	1,047	1	1	12015	40	0			
2	22	50	1,100	1	1	12015	50	0			
2	22	60	1,180	1	1	12015	60	0			
2	22	70	1,188	1	1	12015	70	0			

- Automatic latch and deadbolt
- SUPPLIED AS STANDARD:
striker item 1.06035.00.0 (L=25 mm.)

2	22	40	0,975	1	1	12011	40	0			
2	22	50	1,055	1	1	12011	50	0			
2	22	60	1,144	1	1	12011	60	0			
2	22	70	1,215	1	1	12011	70	0			

- Automatic latch and deadbolt
- SUPPLIED AS STANDARD:
striker item 1.06218.00.0 (L=37 mm.)

2	22	40	1,047	1	1	12016	40	0			
2	22	50	1,116	1	1	12016	50	0			
2	22	60	1,180	1	1	12016	60	0			
2	22	70	1,255	1	1	12016	70	0			



Technical features:

- Rated voltage 12-24V ac and 12-24V dc
- Long lipped ZAL stainless alloy casing
- Steel or stainless steel interchangeable faceplates

Supplied as standard:

- Faceplate fixing screws
- Faceplate spacer (series 05020, 05021, 05005.00.0.20)

On request:

- Booster module item 1.07022.00.0

Hand:

0 = Non-handed

1 = R.H. inwards

L.H. outwards

2 = L.H. inwards

R.H. outwards

Type	Description	Faceplate	Unit weight	Pieces	ITEM				
					Type	Dim.	Hand	Fin.	Pers.

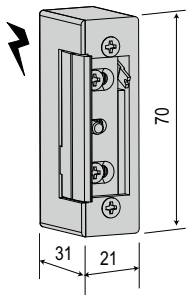

- Electric striker casing
- Voltage 12V ac - Current absorption 0,7 A
- Hold open catch mechanism
- Hold open device

0,185 12 1 15100 00 0

- Electric striker casing
- Voltage 12V ac - Current absorption 0,7A
- Hold open catch mechanism

0,185 12 1 15101 00 0

- Electric striker casing
- Voltage 12V ac/dc - Current absorption 0,7A
- Hold open device

0,170 12 1 15102 00 0

- Electric striker casing
- Voltage 12V ac/dc - Current absorption 0,7A

0,185 12 1 15110 00 0

- Electric striker casing
- Voltage 24V ac - Current absorption 0,4A
- Hold open catch mechanism
- Hold open device

0,185 12 1 15120 00 0

- Electric striker casing
- Voltage 24V ac - Current absorption 0,4A
- Hold open catch mechanism

0,185 12 1 15121 00 0

- Electric striker casing
- Voltage 24V ac/dc - Current absorption 0,4A
- Hold open device

0,185 12 1 15122 00 0

- Electric striker casing
- Voltage 24V ac/dc - Current absorption 0,4A

0,185 12 1 15130 00 0

- Electric striker casing
- Live coils: opening is only obtained if power supply is cut
- Voltage 12V dc - Current absorption 0,20A

0,185 12 1 15140 00 0

Type	Description	Faceplate Kg	Unit weight	Pieces	ITEM			
					Type	Dim.	Hand	Fin. Pers. Spec.
	<ul style="list-style-type: none"> • Electric striker casing • Live coils: opening is only obtained if power supply is cut • Voltage 24V dc - Current absorption 0,12A 		0,185	12	1	15150	00	0
	<ul style="list-style-type: none"> • Electric striker casing • Voltage 12V ac - Current absorption 0,7A • Inside hold open catch mechanism • Hold open device 		0,185	12	1	15160	00	0
	<ul style="list-style-type: none"> • Electric striker casing • Voltage 12V ac - Current absorption 0,25A 		0,185	12	1	15170	00	0

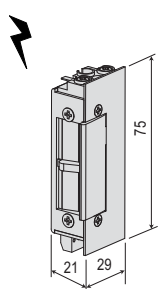

- Electric striker casing
- 1 microswitch
- Adjustable long lip
- Voltage 10/24V ac/dc
- Current absorption 0,24A a 10V dc

0,280 12 1 15200 00 0

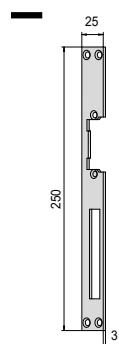

- Square corner steel flat faceplate
- FINISHES
 - gold fin. 06
 - silver fin. 07
 - nickel-plated fin. 12
 - brass lacquered fin. 38

25	0,092	12	1	05001	00	0	06
25	0,092	12	1	05001	00	0	07
25	0,092	12	1	05001	00	0	12

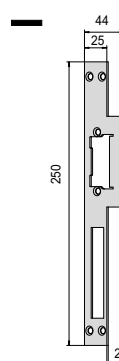

- Square corner steel flat faceplate
- FINISHES
 - hammered gold fin. 06
 - hammered silver fin. 07
 - satin-finished stainless steel fin. 20
 - painted brass fin. 38

25	0,083	12	1	05002	00	1	06
25	0,083	12	1	05002	00	2	06
25	0,083	12	1	05002	00	1	20
25	0,083	12	1	05002	00	2	20

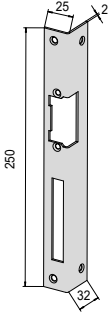
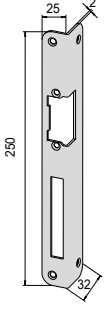
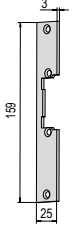
Type	Description	Faceplate	Unit weight	Pieces	ITEM				
					Type	Dim.	Hand	Fin.	Pers.
	• Steel angular faceplate with square corners	25	0,160	6	1	05003	00	1	06
	• FINISHES	25	0,160	6	1	05003	00	2	06
	gold fin. 06	25	0,160	6	1	05003	00	1	07
	silver fin. 07	25	0,160	6	1	05003	00	2	07
	• Steel angular faceplate with round corners	25	0,160	6	1	05004	00	1	06
	• FINISHES	25	0,160	6	1	05004	00	2	06
	gold fin. 06	25	0,160	6	1	05004	00	1	07
	silver fin. 07	25	0,160	6	1	05004	00	2	07
	• Steel flat faceplate with square corners for use with latch only locks	25	0,070	6	1	05005	00	0	06
	• FINISHES	25	0,070	6	1	05005	00	0	07
	gold fin. 06	25	0,070	6	1	05005	00	0	12
	silver fin. 07	25	0,070	6	1	05005	00	0	20
	nickel-plated fin. 12	25	0,070	6	1	05005	00	0	38
	brass lacquered fin. 38								
	satin-finished stainless steel fin. 20								



Technical features:

- Zal stainless alloy asymmetrical casing
- Power input 12V
- effect painted steel faceplate.
- Hold-open device
- Hold-open catch mechanism



Supplied as standard:

- Instruction sheet

Finishes:

- gold effect (fin.06)
- silver effect (fin.07)

Hand:
0 = Non-handed

Type	Description	Faceplate	Unit weight 	Pieces 	ITEM				
					Type	Dim.	Hand	Fin.	Pers. Spec.

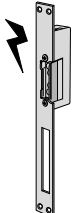
	<ul style="list-style-type: none"> • Non-handed flat faceplate • For locks series 5C000, 53000, 56000, 57200, 57800 	25	0,330	1	1	15001	00	0	06
			25	0,340	1	1	15001	00	0

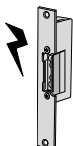
	<ul style="list-style-type: none"> • Non-handed flat faceplate • For locks series 5C000, 53000, 56000, 57200, 57800 	25	0,302	1	1	15005	00	0	06
			25	0,305	1	1	15005	00	0

Amaranth red
lacquered
version
fin. N6



Black lacquered
version fin. 96

Technical features:

- Steel case and striker with fixing tongue
- Brass latch and deadbolt
- Brass draw-back pull and knob

Supplied as standard:

- Striker
- Fixing screws

Finish:

- Amaranth red lacquered case and striker fin. N6
- Black lacquered case and striker fin. 96
- Aluminium-grey powder coated case and striker fin. 95

Hand:

- 1 = R.H. inwards
- 2 = L.H. inwards

Type	Description	Cylinder	Throws	Backset	Unit weight Kg	Pieces	ITEM				
							Type	Dim.	Hand	Fin.	Pers. Spec.

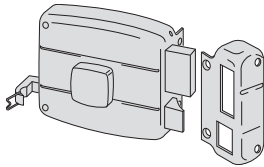

- Inside draw-back pull and thumb turn
- Deadbolt and latch
- Hold open device



Art.
1 0G500 00 0

2	50	0,956	1	1	50110 50 1 N6
2	50	0,956	1	1	50110 50 2 N6
3	60	0,990	1	1	50110 60 1 N6
3	60	0,990	1	1	50110 60 2 N6
3	70	1,120	1	1	50110 70 1 N6
3	70	1,120	1	1	50110 70 2 N6



Art.
1 0G200 55 0

2	50	0,956	1	1	50111 50 1 N6
2	50	0,956	1	1	50111 50 2 N6
3	60	0,990	1	1	50111 60 1 N6
3	60	0,990	1	1	50111 60 2 N6
3	70	1,120	1	1	50111 70 1 N6
3	70	1,120	1	1	50111 70 2 N6

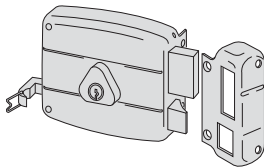

- Inside draw-back pull and cylinder
- Deadbolt and latch
- Hold open device











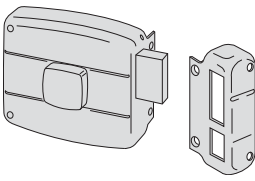

Art.
1 02102 00 0

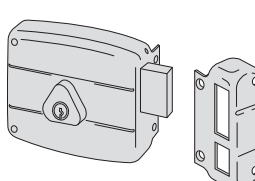

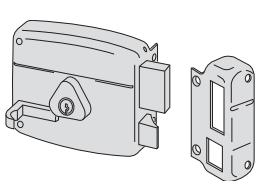

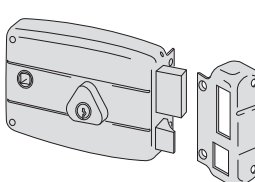

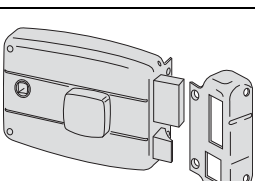

2	50	0,956	1	1	50120 50 1 N6
2	50	0,956	1	1	50120 50 2 N6
3	60	0,990	1	1	50120 60 1 N6
3	60	0,990	1	1	50120 60 2 N6
3	70	1,120	1	1	50120 70 1 N6
3	70	1,120	1	1	50120 70 2 N6

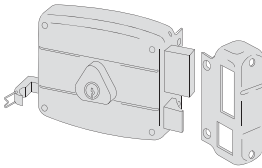

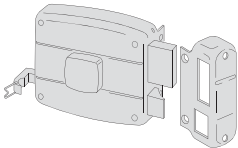
Art.
1 02106 00 0

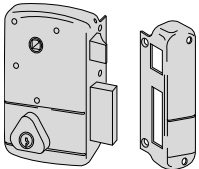
2	50	0,956	1	1	50121 50 1 N6
2	50	0,956	1	1	50121 50 2 N6
3	60	0,990	1	1	50121 60 1 N6
3	60	0,990	1	1	50121 60 2 N6
3	70	1,120	1	1	50121 70 1 N6
3	70	1,120	1	1	50121 70 2 N6

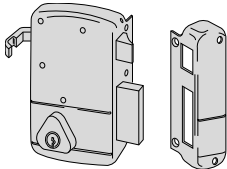
Type	Description	Cylinder	Throws	Backset	Unit weight Kg	Pieces	ITEM										
							Type	Dim.	Hand	Fin.	Pers.	Spec.					
 <ul style="list-style-type: none"> • Inside knob • Deadbolt only 		 Art. 1 0G500 00 0	2	50	0,956	1	1	50130	50	1	N6						
			2	50	0,956	1	1	50130	50	2	N6						
			3	60	0,990	1	1	50130	60	1	N6						
			3	60	0,990	1	1	50130	60	2	N6						
			3	70	1,120	1	1	50130	70	1	N6						
			3	70	1,120	1	1	50130	70	2	N6						
		 Art. 1 0G200 55 0	2	50	0,956	1	1	50131	50	1	N6						
			2	50	0,956	1	1	50131	50	2	N6						
			3	60	0,990	1	1	50131	60	1	N6						
			3	60	0,990	1	1	50131	60	2	N6						
			3	70	1,120	1	1	50131	70	1	N6						
			3	70	1,120	1	1	50131	70	2	N6						
 <ul style="list-style-type: none"> • Inside knob • Deadbolt only 		 Art. 1 02106 00 0	2	50	0,956	1	1	50141	50	1	N6						
			2	50	0,956	1	1	50141	50	2	N6						
			3	60	0,990	1	1	50141	60	1	N6						
			3	60	0,990	1	1	50141	60	2	N6						
			3	70	1,120	1	1	50141	70	1	N6						
			3	70	1,120	1	1	50141	70	2	N6						
		 Art. 1 02106 00 0	2	40	0,574	1	1	50161	40	1	N6						
			2	40	0,574	1	1	50161	40	2	N6						
			 <ul style="list-style-type: none"> • Inside draw-back pull and cylinder • Deadbolt and latch 		 Art. 1 02102 00 0	2	40	0,574	1	1	50160	40	1	N6			
						2	40	0,574	1	1	50160	40	2	N6			
						 Art. 1 02106 00 0	2	40	0,574	1	1	50161	40	1	N6		
							2	40	0,574	1	1	50161	40	2	N6		
 <ul style="list-style-type: none"> • Inside cylinder • Deadbolt and latch • 8 mm through spindle 		 Art. 1 02102 00 0					2	60	0,990	1	1	50170	60	1	N6		
							2	60	0,990	1	1	50170	60	2	N6		
					 Art. 1 02106 00 0		2	60	0,990	1	1	50171	60	1	N6		
							2	60	0,990	1	1	50171	60	2	N6		
						 <ul style="list-style-type: none"> • Inside knob • Deadbolt and latch • 8 mm through spindle 		 Art. 1 0G500 00 0	2	60	0,990	1	1	50180	60	1	N6
									2	60	0,990	1	1	50180	60	2	N6
		 Art. 1 0G200 55 0							2	60	0,990	1	1	50181	60	1	N6
									2	60	0,990	1	1	50181	60	2	N6

Type	Description	Cylinder	Throws	Backset	Unit weight Kg	Pieces	ITEM					
							Type	Dim.	Hand	Fin.	Pers.	Spec.
 <ul style="list-style-type: none"> • Deadbolt and latch • Hold open device • FINISHES <ul style="list-style-type: none"> - aluminium-grey powder coated case and striker - nickel-plated latch, deadbolt, cylinder and draw back pull 	 <p>Art. 1 02102 00 0 12</p>	2	50	0,956	1	1	50420	50	1	95		
		2	50	0,956	1	1	50420	50	2	95		
		3	60	0,990	1	1	50420	60	1	95		
		3	60	0,990	1	1	50420	60	2	95		
		3	70	1,120	1	1	50420	70	1	95		
		3	70	1,120	1	1	50420	70	2	95		
	 <p>Art. 1 02106 00 0 12</p>	2	50	0,956	1	1	50421	50	1	95		
		2	50	0,956	1	1	50421	50	2	95		
		3	60	0,990	1	1	50421	60	1	95		
		3	60	0,990	1	1	50421	60	2	95		
		3	70	1,120	1	1	50421	70	1	95		
		3	70	1,120	1	1	50421	70	2	95		
 <ul style="list-style-type: none"> • Inside draw back pull • Deadbolt and latch • Hold open device • FINISHES <ul style="list-style-type: none"> - aluminium-grey powder coated case and striker - nickel-plated latch, deadbolt, cylinder, draw back pull and thumb turn 	 <p>Art. 1 0G500 00 0 12</p>	2	50	0,956	1	1	50430	50	1	95		
		2	50	0,956	1	1	50430	50	2	95		
		3	60	0,990	1	1	50430	60	1	95		
		3	60	0,990	1	1	50430	60	2	95		
 <ul style="list-style-type: none"> • Inside cylinder • Deadbolt and latch • 8 mm through spindle • FINISHES <ul style="list-style-type: none"> - opaque black powder coated case and striker 	 <p>Art. 1 02102 00 0</p>	2	45	0,866	1	1	50210	45	1	96		
		2	45	0,866	1	1	50210	45	2	96		
		 <p>Art. 1 02106 00 0</p>	2	45	0,866	1	1	50211	45	1	96	
			2	45	0,866	1	1	50211	45	2	96	
 <ul style="list-style-type: none"> • Inside cylinder and draw back pull • Deadbolt and latch • FINISHES <ul style="list-style-type: none"> - opaque black powder coated case and striker 	 <p>Art. 1 02102 00 0</p>	2	45	0,866	1	1	50220	45	1	96		
		2	45	0,866	1	1	50220	45	2	96		
		 <p>Art. 1 02106 00 0</p>	2	45	0,866	1	1	50221	45	1	96	
			2	45	0,866	1	1	50221	45	2	96	



Technical features:

- Purple red painted steel case, striker and plate
- Nickel-plated ground steel deadbolt
- Nickel-plated steel thumb turns

Hand:

1 = R.H. 
inwards

Supplied as standard:

- 3 keys item 1.01070.10.1
- Striker
- Fixing screws
- Brass roses

Type	Description	Cylinder	Throws	Backset	Unit weight 	 Pieces	ITEM			
							Type	Dim.	Hand	Fin.

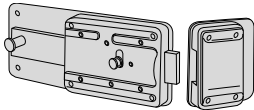

• deadbolt only



1.06500.00.0

6	50	1,345	1	1	55051	50	1
6	60	1,345	1	1	55051	60	1



06200

6	50	1,250	1	1	55054	50	1
6	60	1,335	1	1	55054	60	1

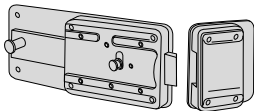

• deadbolt and latch



1.06500.00.0

6	50	1,345	1	1	55071	50	1
6	60	1,345	1	1	55071	60	1



06200

6	50	1,335	1	1	55074	50	1
6	60	1,335	1	1	55074	60	1



Technical features:

- Zinc-plated case and cover
- Brass removable faceplate and strike.
- Non-handed brass flat latch.
- 2 to 13 mm adjustable brass roller.
- Double-throw brass deadbolt, single throw for bathroom doors
- Can be fitted with roses and through-screw handle plates (except for 35 mm backset)
- Can be fitted with cylinder protective roses l = 38 mm and 29 mm (only l = 29 mm for 35 backset)

Finishes:

- ON REQUEST:
Satin nickel-plated brass (Fin. 12)
Stainless steel (Fin. 20)

Hand:

0 = Non-handed

Cylinder to be ordered separately



Supplied as standard:

- Striker
- Fixing screws for lock, striker and cylinder

Type	Description	Throws	Centre Distance	Faceplate	Backset	Unit weight 	Pieces 	ITEM				
								Type	Dim.	Hand	Fin.	Pers. Spec.

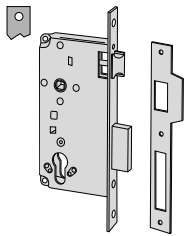

- deadbolt and latch
- SUPPLIED AS STANDARD:
striker item 1.06102.13.0

2	85	22	35	0,658	1	1	5C110 35 0				
2	85	22	40	0,724	1	1	5C110 40 0				
2	85	22	45	0,752	1	1	5C110 45 0				
2	85	22	50	0,720	1	1	5C110 50 0				
2	85	22	60	0,750	1	1	5C110 60 0				
2	85	22	70	0,827	1	1	5C110 70 0				

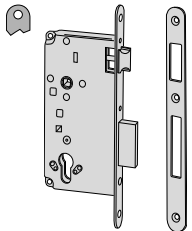

- deadbolt and latch
- SUPPLIED AS STANDARD:
striker item 1.06279.11.0

2	85	22	35	0,680	1	1	5C130 35 0				
2	85	22	40	0,706	1	1	5C130 40 0				
2	85	22	45	0,734	1	1	5C130 45 0				
2	85	22	50	0,768	1	1	5C130 50 0				
2	85	22	60	0,800	1	1	5C130 60 0				
2	85	22	70	0,866	1	1	5C130 70 0				

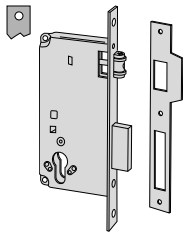

- Roller deadbolt
- SUPPLIED AS STANDARD:
striker item 1.06149.00.0

2	22	35	0,630	1	1	5C120 35 0					
2	22	40	0,680	1	1	5C120 40 0					
2	22	45	0,700	1	1	5C120 45 0					
2	22	50	0,740	1	1	5C120 50 0					
2	22	60	0,750	1	1	5C120 60 0					
2	22	70	0,800	1	1	5C120 70 0					

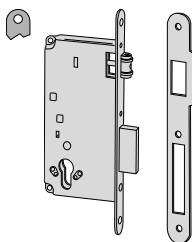

- Roller deadbolt
- SUPPLIED AS STANDARD:
striker

2	22	35	0,630	1	1	5C140 35 0					
2	22	40	0,680	1	1	5C140 40 0					
2	22	45	0,700	1	1	5C140 45 0					
2	22	50	0,740	1	1	5C140 50 0					
2	22	60	0,750	1	1	5C140 60 0					
2	22	70	0,800	1	1	5C140 70 0					

Type	Description	Throws	Centre Distance	Faceplate	Backset	Unit weight 	Pieces 	ITEM			
								Type	Dim.	Hand	Fin.

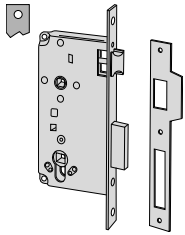

- For bathroom doors
- deadbolt and latch
- SUPPLIED AS STANDARD:
striker item 1.06102.13.0

1	85	22	35	0,650	1	1	5C150 35 0				
1	85	22	40	0,690	1	1	5C150 40 0				
1	85	22	45	0,748	1	1	5C150 45 0				
1	85	22	50	0,750	1	1	5C150 50 0				
1	85	22	60	0,810	1	1	5C150 60 0				
1	85	22	70	0,890	1	1	5C150 70 0				

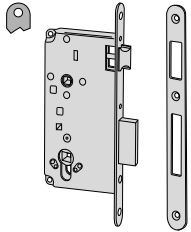

- For bathroom doors
- deadbolt and latch
- 8 mm spindle
- SUPPLIED AS STANDARD:
striker item 1.06279.11.0

1	85	22	45	0,748	1	1	5C170 45 0				
1	85	22	50	0,750	1	1	5C170 50 0				
1	85	22	60	0,810	1	1	5C170 60 0				
1	85	22	70	0,890	1	1	5C170 70 0				



Technical features:

- Zinc-plated case and cover
- Brass removable faceplate and strike.
- Non-handed brass flat latch.
- 2 to 13 mm adjustable brass roller.
- Double-throw brass deadbolt, single throw for bathroom doors
- Can be fitted with roses and through-screw handle plates (except for 35 mm backset)
- Can be fitted with cylinder protective roses (only l = 29 mm for 35 backset)

Supplied as standard:

- Strike plate
- Fixing screws for lock, striker and cylinder

Finishes:

- Finishes available at no extra charge:
 - nickel-plated steel (Fin. 12)
 - bronze-plated steel (Fin. 47)

Hand:
0 = Non-handed

Cylinder to be ordered separately



Type	Description	Throws	Centre Distance	Faceplate	Backset	Unit weight 	Pieces 	ITEM			
								Type	Dim.	Hand	Fin. Pers. Spec.

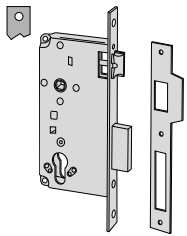

- Deadbolt and latch
- SUPPLIED AS STANDARD: striker item 1.06102.10.0

2	85	22	35	0,628	1	1	5C611 35 0			
2	85	22	40	0,643	1	1	5C611 40 0			
2	85	22	45	0,668	1	1	5C611 45 0			
2	85	22	50	0,718	1	1	5C611 50 0			
2	85	22	60	0,768	1	1	5C611 60 0			
2	85	22	70	0,768	1	1	5C611 70 0			

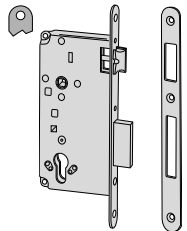

- Deadbolt and latch
- SUPPLIED AS STANDARD: striker item 1.06100.10.0

2	85	22	35	0,658	1	1	5C631 35 0			
2	85	22	40	0,678	1	1	5C631 40 0			
2	85	22	45	0,718	1	1	5C631 45 0			
2	85	22	50	0,718	1	1	5C631 50 0			
2	85	22	60	0,768	1	1	5C631 60 0			
2	85	22	70	0,820	1	1	5C631 70 0			

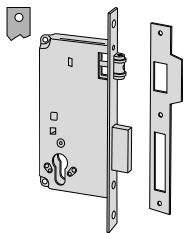

- Roller deadbolt
- SUPPLIED AS STANDARD: striker item 1.06102.10.0

2	22	40	0,620	1	1	5C621 40 0			
2	22	45	0,670	1	1	5C621 45 0			
2	22	50	0,718	1	1	5C621 50 0			
2	22	60	0,778	1	1	5C621 60 0			

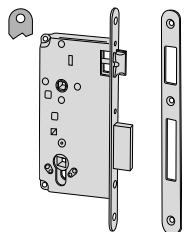

- For toilet doors
- deadbolt and latch
- SUPPLIED AS STANDARD: striker item 1.06100.10.0

1	85	22	45	0,730	1	1	5C671 45 0			
1	85	22	50	0,767	1	1	5C671 50 0			
1	85	22	60	0,826	1	1	5C671 60 0			
1	85	22	70	0,868	1	1	5C671 70 0			



Technical features:

- Faceplate and striker in brass plated satin steel version
- Zinc-plated steel case
- Reversible latch
- Steel deadbolt 9,5 mm thick
- Case cover to protect against dirt and chips

Supplied as standard:

- Striker
- Lock and cylinder fixing screws

On request:

- European profile cylinders

Standards:

- This lock series is fully tested to 12209:2016
- Grade 3 - Category of use (For use by the public where there is little incentive to exercise care and where there is a high chance of misuse, e.g. doors in public buildings)

|3|S|7|0|0|F|2|0

Cylinder to be ordered separately



Type	Description	Throws	Centre Distance	Faceplate	Backset	Unit weight Kg	Pieces	ITEM			
								Type	Dim.	Hand	Fin.

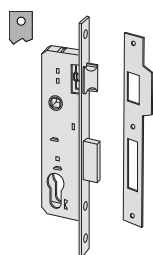

REPLACING 5C011 SERIES

- Satin brass steel faceplate
- Deadbolt and latch
- SUPPLIED AS STANDARD:
- Satin brass-plated steel strike plate

1	85	22	21	0,450	12	1	5C012	20	0
1	85	22	25	0,511	12	1	5C012	25	0
1	85	22	30	0,530	12	1	5C012	30	0

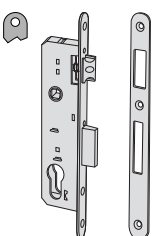

REPLACING 5C031 SERIES

- Satin brass steel faceplate
- Deadbolt and latch
- SUPPLIED AS STANDARD:
- Satin brass-plated steel strike plate

1	85	22	21	0,500	12	1	5C032	20	0
1	85	22	25	0,530	12	1	5C032	25	0
1	85	22	30	0,570	12	1	5C032	30	0

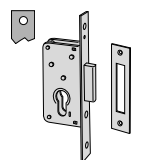

- Satin brass steel faceplate
- Deadbolt
- SUPPLIED AS STANDARD:
- Satin brass-plated steel strike plate art. 1.07032.00.0

1	22	25	0,360	1	1	52210	25	0
1	22	30	0,380	1	1	52210	30	0

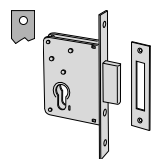

- Satin brass steel faceplate
- Deadbolt
- SUPPLIED AS STANDARD:
- Satin brass-plated steel strike plate art.1.07032.00.0

2	22	35	0,410	1	1	52310	35	0
2	22	40	0,430	1	1	52310	40	0
2	22	45	0,451	1	1	52310	45	0
2	22	50	0,470	1	1	52310	50	0
2	22	60	0,500	1	1	52310	60	0
2	22	70	0,530	1	1	52310	70	0



Technical features:

- Zinc-plated steel case

Hand:

0 = Non-handed

Supplied as standard:

- Lock and cylinder fixing screws
- Instruction sheet

On request:

- Protective rose item 1.06490.02.0, 1.06460.50/51/60/0
- Spacers item 1.06472.40.0
- Set of controls for external extension bolts item 06452.05.00.0TB

Type	Description	Throws	Centre Distance	Faceplate	Backset	Unit weight 	Pieces 	ITEM				
								Type	Dim.	Hand	Fin.	Pers. Spec.

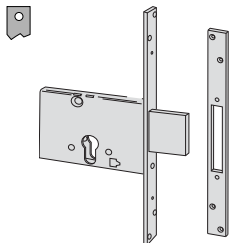

- Deadbolt only in zinc-plated steel, 1 locking point
- Zinc-plated faceplate and strike
- Interchangeable with series 57010 (double-bitted key locks)
- SUPPLIED AS STANDARD:
Roses item 1.06043.00.0 (2 pcs)
Strike item 1.06283.02.0.B7

3	25	52	0,825	1	1	56010	50	0			
3	25	60	0,875	1	1	56010	60	0			
3	25	70	0,925	1	1	56010	70	0			

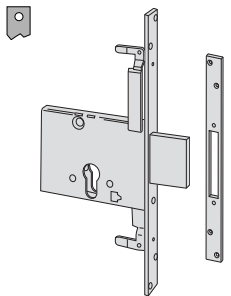

- Deadbolt only in zinc-plated steel, 3 locking points
- Zinc-plated faceplate and strike
- Interchangeable with series 57015 (double bitted key locks)
- SUPPLIED AS STANDARD:
Roses item 1.06043.00.0 (2 pcs)
Strike item 1.06283.02.0.B7
Guide plate for extension bolts item 1.06085.00.0 (2 pcs)
Top strike item 1.06084.00.0
- ON REQUEST:
Extension bolts item 1.06415.00.0
Floor strike item 1.06086.00.0

3	25	60	0,925	1	1	56015	60	0			
3	25	70	0,975	1	1	56015	70	0			

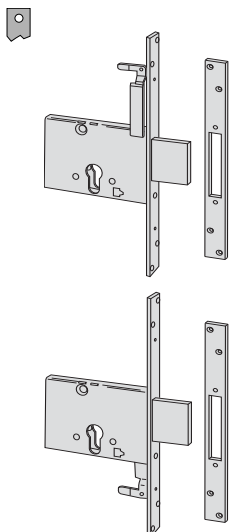

- Deadbolt only in zinc-plated steel, lock set
- Zinc-plated steel faceplate and strike
- Interchangeable with 57020 series (double-bitted key)
- SUPPLIED AS STANDARD:
Escutcheons item 1.06043.00.0 (4 pcs)
Strike item 1.06283.02.0.B7 (2 pcs)
Guide plate for extension bolts, item 1.06085.00.0 (2 pcs)
Top strike item 1.06084.00.0
- ON REQUEST:
Extension bolts item 1.06416.00.0
Floor strike item 1.06086.00.0

3	25	60	1,750	1	1	56020	60	0			
3	25	70	1,850	1	1	56020	70	0			

Type	Description	Throws	Centre Distance	Faceplate	Backset	Unit weight 	Pieces 	ITEM			
								Type	Dim.	Hand	Fin.

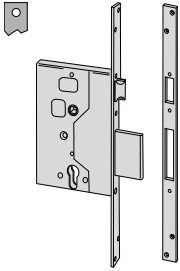

- Nickel-plated steel deadbolt and latchbolt
- Faceplate and strike in nickel-plated satin-finished steel
- SUPPLIED AS STANDARD:
Strike item 1.06271.00.0

3	85	25	60	1,300	1	1 56250 60 0
---	----	----	----	-------	---	--------------

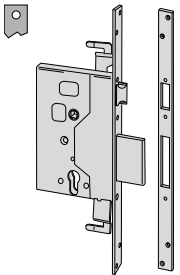

- Nickel-plated steel deadbolt and latchbolt
- Faceplate and strike in nickel-plated satin-finished steel
- Pre-set for additional locking points
- SUPPLIED AS STANDARD:
Strike item 1.06272.00.0
Pair of guide plates for the extension bolts, item 1.06085.00.0
Top strike item. 1.06084.00.0
- ON REQUEST:
Extension bolts item 1.06415.00.0
Floor strike item 1.06086.00.0

3	85	25	60	1,535	10	1 56255 60 0
---	----	----	----	-------	----	--------------



Technical features:

- Painted brass plated satin steel faceplate and striker
- Zinc-plated steel case
- Flat, reversible, nickel-plated latch
- Nickel-plated steel triple bolt

Supplied as standard:

- Striker
- Cylinder fixing screws
- Set of controls for external extension bolts item 06452.05.00.0TB

Hand:
0 = Non-handed

Cylinder to be ordered separately



Type	Description	Throws	Centre Distance	Faceplate Backset	Kg	Pieces	ITEM			
							Type	Dim.	Hand	Fin. Pers. Spec.

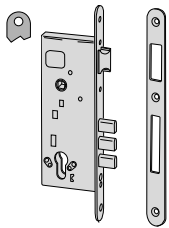

- Deadbolt and latch
- SUPPLIED AS STANDARD: striker item 1.06279.12.0

2	85	22	45	0,805	1	1	52520	45	0
2	85	22	50	0,835	1	1	52520	50	0
2	85	22	60	0,915	1	1	52520	60	0

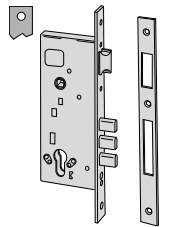

- Deadbolt and latch
- SUPPLIED AS STANDARD: striker item 1.06279.11.0

2	85	22	45	0,800	1	1	52521	45	0
2	85	22	50	0,840	1	1	52521	50	0
2	85	22	60	0,905	1	1	52521	60	0

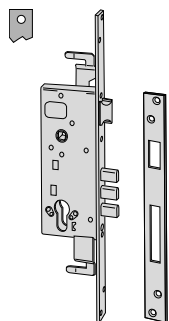

- Deadbolt and latch
- Pre-set for additional locking points
- SUPPLIED AS STANDARD: striker item 1.06284.00.0
- Two guides for extension bolts item 1.06085.00.0
- Upper striker item 1.06084.00.0
- ON REQUEST: extension bolts item 1.06415.00.0
- Floor striker item 1.06086.00.0

2	85	25	45	1,145	1	1	52526	45	0
2	85	25	50	1,180	1	1	52526	50	0
2	85	25	60	1,245	1	1	52526	60	0



Technical features:

- Laquered polished brass removable faceplate and striker
- Zinc-plated steel case
- Reversible, nickel-plated silent action latch
- Nickel-plated bolt for latch dead-locking (if provided)
- Nickel-plated cut-resistant deadbolt, with a 25 mm. protrusion
- Anti-corrosion galvanised internal components

Supplied as standard:

- Striker
- Fixing screws
- Instruction sheet

On request:

- Satin stainless steel faceplate and striker (fin 20)

Standards:

- Locks with satin stainless steel faceplate and striker (finish 20), are certified fire-resistant by the American Underwrite Laboratories (UL LISTED R 14945(N))
- CE marking in accordance with the regulation 305/2011
- Standard reference:
UNI EN 179
UNI EN 1125
UNI EN 12209

Hand:

0 = Non-handed

Cylinder to be ordered separately



Type	Description	Throws	Centre Distance	Faceplate	Backset	Unit weight Kg	Pieces	ITEM			
								Type	Dim.	Hand	Fin.

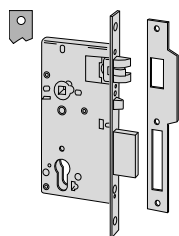

- For entrance doors
- Deadbolt and dead-locking latch
- OPERATION:
the latch-bolt is operated by handle or cylinder from either side
The deadbolt is operated by cylinder from either side
- SUPPLIED AS STANDARD:
Square striker item 1.06106.20.0

1	85	22	60	0,950	1	1	52710	60	0			
1	85	22	70	1,000	1	1	52710	70	0			
1	85	22	80	1,050	1	1	52710	80	0			
1	85	22	90	1,100	1	1	52710	90	0			

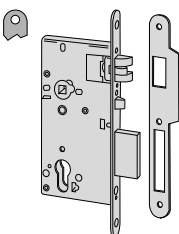

- For entrance doors
- Deadbolt and dead-locking latch
- OPERATION:
the latch-bolt is operated by handle or cylinder from either side
The deadbolt is operated by cylinder from either side
- SUPPLIED AS STANDARD:
Square striker item 1.06106.25.0

1	85	22	60	0,950	1	1	52711	60	0			
1	85	22	70	1,000	1	1	52711	70	0			
1	85	22	80	1,050	1	1	52711	80	0			
1	85	22	90	1,100	1	1	52711	90	0			

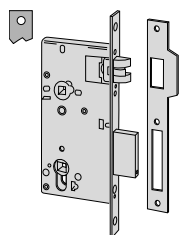

- For bathroom and bedroom
- deadbolt and latch
- OPERATION:
the latch-bolt is operated by handle from either side
The deadbolt is operated by a 8 mm spindle
- SUPPLIED AS STANDARD:
Square striker item 1.06155.20.0

1	85	22	60	0,950	1	1	52730	60	0			
1	85	22	70	1,000	1	1	52730	70	0			

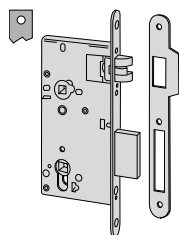

- For bathroom and bedroom
- deadbolt and latch
- OPERATION:
the latch-bolt is operated by handle from either side
The deadbolt is operated by a 8 mm spindle
- SUPPLIED AS STANDARD:
Round striker item 1.06155.25.0

1	85	22	60	0,950	1	1	52731	60	0			
1	85	22	70	1,000	1	1	52731	70	0			
1	85	22	80	1,050	1	1	52731	80	0			
1	85	22	90	1,100	1	1	52731	90	0			

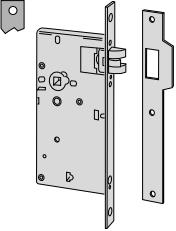
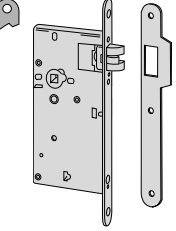
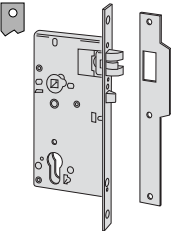
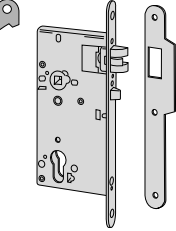
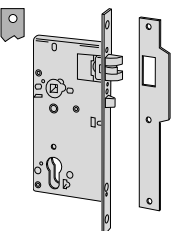
Type	Description	Throws	Centre Distance	Faceplate Backset	Unit weight Kg	Pieces	ITEM				
							Type	Dim.	Hand	Fin.	Pers. Spec.
	<ul style="list-style-type: none"> • For passage doors • Latch-bolt only • OPERATION: The latch-bolt is operated by handle from either side • SUPPLIED AS STANDARD: Square striker item 1.06156.20.0 	22	60	0,900	1	1	52750	60	0		
		22	70	0,950	1	1	52750	70	0		
		22	80	1,000	1	1	52750	80	0		
	<ul style="list-style-type: none"> • For passage doors • Latch-bolt only • OPERATION: The latch-bolt is operated by handle from either side • SUPPLIED AS STANDARD: Round striker item 1.06156.25.0 	22	60	0,900	1	1	52751	60	0		
		22	70	0,950	1	1	52751	70	0		
		22	90	1,050	1	1	52751	90	0		
	<ul style="list-style-type: none"> • For external doors • Dead-locking latch-bolt only • OPERATION: The latch-bolt is operated by handle or cylinder from either side The outside handle must be de-activated • SUPPLIED AS STANDARD: Square striker item 1.06158.20.0 	1	85	22	60	0,900	1	1	52755	60	0
		1	85	22	70	0,950	1	1	52755	70	0
		1	85	22	80	1,000	1	1	52755	80	0
	<ul style="list-style-type: none"> • For external doors • Dead-locking latch-bolt only • OPERATION: The latch-bolt is operated by handle or cylinder from either side The outside handle must be de-activated • SUPPLIED AS STANDARD: Round striker item 1.06158.25.0 	85	22	60	0,900	1	1	52756	60	0	
		85	22	70	0,950	1	1	52756	70	0	
		85	22	80	1,000	1	1	52756	80	0	
	<ul style="list-style-type: none"> • FUNCTION TYPE B: • For panic function doors (for the suitable panic exit device to install, see the relevant catalogue) • Latch only with antipicking device • Split square spindle • Reversible panic function • The outside handle can be disactivated with the key • Outside: the latch can be operated with the handle, the key activates/disactivates the handle • Inside: the latch can be operated with the handle or the panic exit device, the key activates/disactivates the outside handle • Note: when the door is opened from the inside with the handle or the panic exit device, the outside handle remains disactivated after the door is closed (in stand-by) 	85	22	60	0,900	1	1	52760	60	0	
		85	22	70	0,950	1	1	52760	70	0	
		85	22	90	1,050	1	1	52760	90	0	

Type	Description	Throws	Centre Distance	Faceplate	Backset	Unit weight Kg	Pieces	ITEM				
								Type	Dim.	Hand	Fin.	Pers. Spec.
	<ul style="list-style-type: none"> • FUNCTION TYPE B: • For panic function doors (for the suitable panic exit device to install, see the relevant catalogue) • Latch only with antipicking device • Split square spindle • Reversible panic function • The outside handle can be disactivated with the key • Outside: the latch can be operated with the handle, the key activates/disactivates the handle • Inside: the latch can be operated with the handle or panic exit device, the key activates/disactivates the outside handle • Note: when the door is opened from the inside with the handle or the panic exit device, the outside handle remains disactivated after the door is closed (in stand-by) 	85	22	60	0,900	1	1	52761	60	0		
		85	22	70	0,950	1	1	52761	70	0		
		85	22	80	1,000	1	1	52761	80	0		
	<ul style="list-style-type: none"> • FUNCTION TYPE A: • for panic function doors (for the suitable panic exit device to install, see the relevant catalogue) • Through square spindle • The deadbolt is automatically released when closing the the door • Outside: latch and deadbolt are operated only with the key • Inside: latch and deadbolt are operated with the key, the handle or the panic exit device 	1	85	22	60	0,950	1	1	52840	60	0	
		1	85	22	70	1,000	1	1	52840	70	0	
		1	85	22	80	1,050	1	1	52840	80	0	
		1	85	22	90	1,100	1	1	52840	90	0	
	<ul style="list-style-type: none"> • FUNCTION TYPE A: • for panic function doors (for the suitable panic exit device to install, see the relevant catalogue) • Through square spindle • The deadbolt is automatically released when closing the the door • Outside: latch and deadbolt are operated only with the key • Inside: latch and deadbolt are operated with the key, the handle or the panic exit device 	1	85	22	60	0,950	1	1	52860	60	0	
		1	85	22	70	1,000	1	1	52860	70	0	
		1	85	22	80	1,050	1	1	52860	80	0	
		1	85	22	90	1,100	1	1	52860	90	0	
	<ul style="list-style-type: none"> • FUNCTION TYPE A: • for panic function doors (for the suitable panic exit device to install, see the relevant catalogue) • Latch and deadbolt with antipicking device • Through square spindle • Outside: latch and deadbolt are operated only with the key • Inside: latch and deadbolt are operated with the key, the handle or the panic exit device 	1	85	22	60	0,950	1	1	52842	60	0	
		1	85	22	70	1,000	1	1	52842	70	0	
		1	85	22	80	1,050	1	1	52842	80	0	
		1	85	22	90	1,100	1	1	52842	90	0	
	<ul style="list-style-type: none"> • FUNCTION TYPE A: • for panic function doors (for the suitable panic exit device to install, see the relevant catalogue) • Latch and deadbolt with antipicking device • Through square spindle • Outside: latch and deadbolt are operated only with the key • Inside: latch and deadbolt are operated with the key, the handle or the panic exit device 	1	85	22	60	0,950	1	1	52862	60	0	
		1	85	22	70	1,000	1	1	52862	70	0	
		1	85	22	80	1,050	1	1	52862	80	0	
		1	85	22	90	1,100	1	1	52862	90	0	

Type	Description	Throws	Centre Distance	Faceplate Backset	Unit weight Kg	Pieces	ITEM			
							Type	Dim. Hand	Fin.	Pers. Spec.

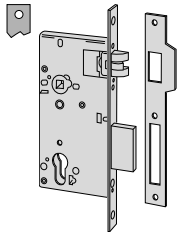

- **FUNCTION TYPE D:**
- for panic function doors (for the suitable panic exit device to install, see the relevant catalogue)
- Split square spindle
- Reversible panic function
- Outside: the latch can be operated with the handle
- Inside: latch and deadbolt are operated with the handle or the panic exit device
- The key operates only the deadbolt from either side
- Note: when the door is opened from the inside with the handle or the panic exit device, the deadbolt remains withdrawn after closing the door and the outside handle remains activated and can withdraw the latch (door open)

1	85	22	60	0,950	1	1	52844	60	0
1	85	22	70	1,000	1	1	52844	70	0
1	85	22	80	1,050	1	1	52844	80	0
1	85	22	90	1,100	1	1	52844	90	0

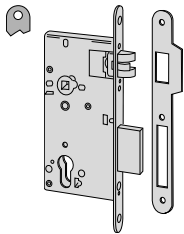

- **FUNCTION TYPE D:**
- for panic function doors (for the suitable panic exit device to install, see the relevant catalogue)
- Split square spindle
- Reversible panic function
- Outside: the latch can be operated with the handle
- Inside: latch and deadbolt are operated with the handle or the panic exit device
- The key operates only the deadbolt from either side
- Note: when the door is opened from the inside with the handle or the panic exit device, the deadbolt remains withdrawn after closing the door and the outside handle remains activated and can withdraw the latch (door open)

1	85	22	60	0,950	1	1	52864	60	0
1	85	22	70	1,000	1	1	52864	70	0
1	85	22	90	1,100	1	1	52864	90	0



Technical features:

- Satin lacquered brass faceplate and striker
- Semi-matt black lacquered steel case
- Reversible, nickel-plated latch
- Nickel-plated, antipicking bolt (if provided)
- Nickel-plated deadbolt
- Can be fitted with: escutcheons, roses, handle plates and through screws
- Through-spindle

Hand:

0 = Non-handed

Cylinder to be ordered separately



Supplied as standard:

- Striker
- Striker and cylinder fixing screws

On request:

- Satin lacquered chrome-plated finish (fin. 18)

Type	Description	Throws	Centre Distance	Faceplate	Backset	Unit weight Kg	Pieces	ITEM			
								Type	Dim.	Hand	Fin.

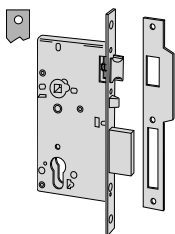

- FUNCTION TYPE A:
- FOR PANIC FUNCTION DOORS (for the suitable panic exit device to install, see the relevant catalogue)
- Deadbolt and dead-locking latch
- SUPPLIED AS STANDARD:
striker item 1.06106.01.0
- ON REQUEST:
Faceplate 18x240 (pers. AG)
Without antipicking bolt (suffix AF)

1	85	22	40	0,720	1	1	52810	40	1				
1	85	22	40	0,720	1	1	52810	40	2				
1	85	22	45	0,760	1	1	52810	45	0				
1	85	22	50	0,780	1	1	52810	50	0				
1	85	22	70	0,920	1	1	52810	70	0				

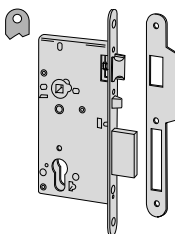

- FUNCTION TYPE A:
- FOR PANIC FUNCTION DOORS (for the suitable panic exit device to install, see the relevant catalogue)
- Deadbolt and dead-locking latch
- SUPPLIED AS STANDARD:
striker item 1.06106.05.0
- ON REQUEST:
Faceplate 18x240 (spec. AG)
Without antipicking bolt (suffix AF)

1	85	22	40	0,720	1	1	52830	40	1				
1	85	22	40	0,720	1	1	52830	40	2				
1	85	22	50	0,780	1	1	52830	50	0				
1	85	22	70	0,920	1	1	52830	70	0				

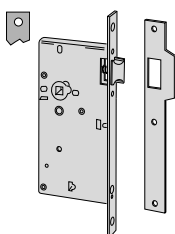

- FOR PASSAGE DOORS
- Latch bolt only
- Supplied as standard strikers

	85	22	60	0,790	1	1	52318	60	0				
--	----	----	----	-------	---	---	-------	----	---	--	--	--	--

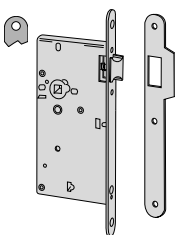

- FOR PASSAGE DOORS
- Latch bolt only
- Supplied as standard strikers

	85	22	60	0,790	1	1	52338	60	0				
--	----	----	----	-------	---	---	-------	----	---	--	--	--	--

Technical features:

- Nickel-plated satin steel faceplate and striker
- Zinc-plated steel case
- Reversible, nickel-plated latch
- Nickel-plated steel deadbolt

Supplied as standard:

- Striker
- 2 escutcheons :
inside item 1.06143.00.0,
outside item 1.06082.00.0
- 3 keys
- Fixing screws

Hand:
0 = Non-handed

Type	Description	Key item	Throws	Centre Distance	Faceplate	Backset	Unit weight 	Pieces 	ITEM			
									Type	Dim.	Hand	Fin.

<ul style="list-style-type: none"> • Deadbolt only • SUPPLIED AS STANDARD: striker item 1.06231.00.0 	1 00100 00 1	4	25	52	1,150	1	1	57010 50 0				
		4	25	60	1,200	1	1	57010 60 0				
		4	25	70	1,250	1	1	57010 70 0				
		4	25	52	1,160	1	1	57010 51 0				
		4	25	60	1,310	1	1	57010 61 0				
		4	25	70	1,280	1	1	57010 71 0				

<ul style="list-style-type: none"> • Deadbolt only • Pre-set for additional locking points • SUPPLIED AS STANDARD: striker item 1.06235.00.0 Two guides for extension bolts item 1.06085.00.0 Upper striker item 1.06084.00.0 • ON REQUEST: extension bolts item 1.06415.00.0 Floor striker item 1.06086.00.0 	1 00100 00 1	4	25	60	1,385	1	1	57015 60 0				
		4	25	70	1,430	1	1	57015 70 0				
		4	25	60	1,410	1	1	57015 61 0				
		4	25	70	1,460	1	1	57015 71 0				

<ul style="list-style-type: none"> • Pair of locks deadbolt only • Pre-set for additional locking points • SUPPLIED AS STANDARD: two strikers item 1.06235.00.0 two guides for extension bolts item 1.06085.00.0 Upper striker item 1.06084.00.0 • ON REQUEST: extension bolts item 1.06416.00.0 Floor striker item 1.06086.00.0 	1 00100 00 1	4	25	60	2,455	1	1	57020 60 0				
		4	25	70	2,540	1	1	57020 70 0				
		4	25	60	2,610	1	1	57020 61 0				
		4	25	70	2,550	1	1	57020 71 0				

Type	Description	Key item	Throws	Centre Distance	Faceplate	Backset	Unit weight 	Pieces 	ITEM			
									Type	Dim. Hand	Fin.	Peris. Spec.
	<ul style="list-style-type: none"> • Deadbolt and latch • SUPPLIED AS STANDARD: striker item 1.06271.00.0 	 1 00100 00 1	4	85	25	60	1,475	1	1	57250	60	0
		 1 00102 00 1	4	85	25	60	1,500	1	1	57250	61	0
	<ul style="list-style-type: none"> • Deadbolt and latch • Pre-set for additional locking points • SUPPLIED AS STANDARD: striker item 1.06272.00.0 Two guides for extension bolts item 1.06085.00.0 Upper striker item 1.06084.00.0 • ON REQUEST: extension bolts item 1.06415.00.0 Floor striker item 1.06086.00.0 	 1 00100 00 1	4	85	25	60	1,700	10	1	57255	60	0
		 1 00102 00 1	4	85	25	60	1,750	1	1	57255	61	0
	<ul style="list-style-type: none"> • For metal profiles • deadbolt and latch • Pre-set for additional locking points • Without striker • ON REQUEST: extension bolts item 1.06415.00.0 Floor striker item 1.06086.00.0 	 1 00100 00 1	4	85	25	60	1,500	1	1	57256	60	0



Technical features:



- Painted, brass plated satin steel faceplate and striker
- Zinc-plated steel case
- Reversible, nickel-plated latch
- Nickel-plated steel multiple deadbolts



Supplied as standard:

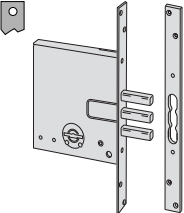

- Striker
- 2 escutcheons: inside item 1.06143.00.0, outside item 1.06082.00.0
- 3 keys
- Fixing screws

Hand:
0 = Non-handed

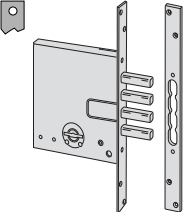
Type	Description	Key item	Throws	Centre Distance	Faceplate	Backset	Unit weight	Pieces	ITEM			
									Type	Dim.	Hand	Fin.

	<ul style="list-style-type: none"> • 3 deadbolts only • SUPPLIED AS STANDARD: striker item 1.06283.00.0 	 1 00101 00 1	4	25	50	1,065	1	1	57028 50 0				
		 1 00102 00 1	4	25	51	1,065	1	1	57028 51 0				

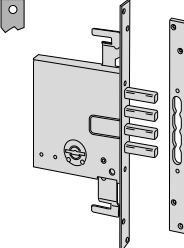
	<ul style="list-style-type: none"> • 4 deadbolts only • SUPPLIED AS STANDARD: striker item 1.06283.01.0 	 1 00101 00 1	4	25	60	1,150	1	1	57028 60 0				
		 1 00102 00 1	4	25	61	1,150	1	1	57028 61 0				

	<ul style="list-style-type: none"> • 4 deadbolts only • Pre-set for additional locking points • SUPPLIED AS STANDARD: Two guides for extension bolts item 1.06085.00.0 Upper striker item 1.06084.00.0 striker item 1.06283.02.0 • ON REQUEST: extension bolts item 1.06415.00.0 Floor striker item 1.06086.00.0 	 1 00101 00 1	4	25	60	1,400	1	1	57033 60 0				
---	--	---	---	----	----	-------	---	---	------------	--	--	--	--

TO BE DISCONTINUED

Type	Description	Key item	Throws	Centre Distance	Faceplate	Backset	Unit weight 	Pieces 	ITEM			
									Type	Dim. Hand	Fin.	Pers. Spec.

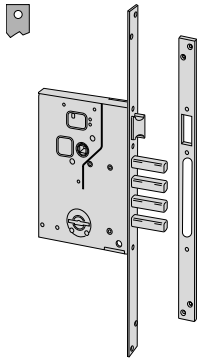

- Latch and 4 deadbolts
- SUPPLIED AS STANDARD:
striker item 1.06284.00.0



1 00101 00 1

4 85 25 60 1,410 1 1 57260 60 0



1 00102 00 1

4 85 25 60 1,425 1 1 57260 61 0

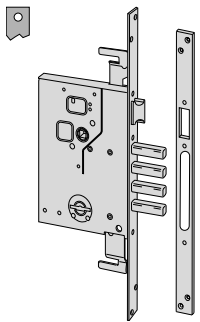

- Latch and 4 deadbolts
- Pre-set for additional locking points
- SUPPLIED AS STANDARD:
Two guides for extension bolts item 1.06085.00.0
Upper striker item 1.06084.00.0
striker item 1.06284.00.0
- ON REQUEST:
extension bolts item 1.06415.00.0
Floor striker item 1.06086.00.0



1 00101 00 1

4 85 25 60 1,700 1 1 57265 60 0

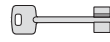

1 00102 00 1

4 85 25 60 1,715 1 1 57265 61 0



Technical features:

- Nickel-plated steel faceplate and striker
- Zinc-plated steel case
- Flat, reversible, nickel-plated latch
- Nickel-plated steel deadbolt
- Adjustable roller from 2 to 13 mm

Hand:

0 = Non-handed

Supplied as standard:

- Striker
- 2 escutcheons: inside item 1.06143.00.0, outside item 1.06082.00.0
- 3 keys
- Fixing screws

Type	Description	Key item	Throws	Centre Distance	Faceplate	Backset	Unit weight	Pieces	ITEM			
									Type	Dim.	Hand	Fin.

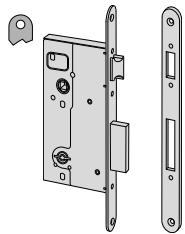

- Deadbolt and latch
- SUPPLIED AS STANDARD: striker item 1.06279.00.0



1 00100 00 1

2	85	22	40	0,950	1	1	57210	40	0			
2	85	22	45	0,900	1	1	57210	45	0			
2	85	22	50	1,000	1	1	57210	50	0			
2	85	22	60	1,070	1	1	57210	60	0			

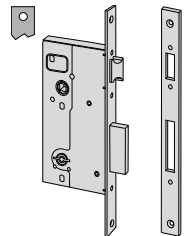

- Deadbolt and latch
- SUPPLIED AS STANDARD: striker item 1.06278.00.0



1 00100 00 1

2	85	22	40	0,935	1	1	57211	40	0			
2	85	22	45	0,980	1	1	57211	45	0			
2	85	22	50	1,020	1	1	57211	50	0			
2	85	22	60	1,070	1	1	57211	60	0			



1 00102 00 1

2	85	22	40	0,890	1	1	57211	41	0			
2	85	22	45	0,890	1	1	57211	46	0			
2	85	22	50	1,030	1	1	57211	51	0			
2	85	22	60	1,075	1	1	57211	61	0			

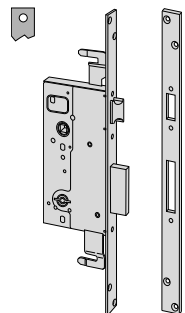

- Deadbolt and latch
- Pre-set for additional locking points
- SUPPLIED AS STANDARD: striker item 1.06272.00.0
- Two guides for extension bolts item 1.06085.00.0
- Upper striker item 1.06084.00.0
- ON REQUEST: extension bolts item 1.06415.00.0
- Floor striker item 1.06086.00.0



1 00100 00 1

2	85	25	45	1,340	1	1	57215	45	0			
2	85	25	50	1,360	10	1	57215	50	0			
2	85	25	60	1,420	1	1	57215	60	0			

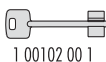

1 00102 00 1

2	85	25	45	1,340	1	1	57215	46	0			
2	85	25	50	1,365	1	1	57215	51	0			
2	85	25	60	1,430	1	1	57215	61	0			

Type	Description	Key item	Throws	Centre Distance	Faceplate	Backset	Unit weight Kg	Pieces	ITEM				
									Type	Dim.	Hand	Fin.	Pers. Spec.

	<ul style="list-style-type: none"> • Deadbolt and roller latch • Pre-set for additional locking points • SUPPLIED AS STANDARD: Special striker Two guides for extension bolts item 1.06085.00.0 Top striker item 1.06084.00.0 • ON REQUEST: extension bolts item 1.06415.00.0 Floor striker item 1.06086.00.0 		2	85	25	45	1,280	1	1 57217 45 0				
			2	85	25	50	1,310	1	1 57217 50 0				
			2	85	25	60	1,260	1	1 57217 60 0				
			TO BE DISCONTINUED										

	<ul style="list-style-type: none"> • Deadbolt only • SUPPLIED AS STANDARD: striker item 1.06282.00.0 		2	22	40		0,690	1	1 57220 40 0			
			2	22	45		0,710	1	1 57220 45 0			
			2	22	50		0,730	1	1 57220 50 0			
			2	22	60		0,765	1	1 57220 60 0			
			2	22	40		0,700	1	1 57220 41 0			
			2	22	45		0,640	1	1 57220 46 0			
			2	22	50		0,740	1	1 57220 51 0			
			2	22	60		0,680	1	1 57220 61 0			

	<ul style="list-style-type: none"> • Deadbolt only • Pre-set for additional locking points • SUPPLIED AS STANDARD: striker item 1.06235.00.0 Two guides for extension bolts item 1.06085.00.0 Upper striker item 1.06084.00.0 • ON REQUEST: extension bolts item 1.06415.00.0 Floor striker item 1.06086.00.0 		2	25	45		0,945	1	1 57225 45 0			
			2	25	50		0,960	1	1 57225 50 0			
			2	25	60		1,000	1	1 57225 60 0			
				2	25	45		0,950	1	1 57225 46 0		
		2		25	50		0,960	1	1 57225 51 0			
		2		25	60		1,000	1	1 57225 61 0			

	<ul style="list-style-type: none"> • Pair of locks deadbolt only • Pre-set for additional locking points • SUPPLIED AS STANDARD: Two strikers item 1.06235.00.0 Two guides for extension bolts item 1.06085.00.0 Top striker item 1.06084.00.0 • ON REQUEST: extension bolts item 1.06416.00.0 Floor striker item 1.06086.00.0 		2	25	45		1,670	1	1 57230 45 0			
			2	25	50		1,720	1	1 57230 50 0			
			2	25	60		1,790	1	1 57230 60 0			
				2	25	45		1,680	1	1 57230 46 0		
		2		25	50		1,735	1	1 57230 51 0			
		2		25	60		1,812	1	1 57230 61 0			



Technical features:

- Painted, brass plated steel faceplate and striker
- Zinc-plated steel case
- Flat, reversible, nickel-plated latch
- Nickel-plated steel multiple deadbolts

Hand:

0 = Non-handed

Supplied as standard:

- Striker
- Escutcheons item 1.06144.10.0
- 3 keys
- Fixing screws

Type	Description	Key item	Throws	Centre Distance	Faceplate Backset	Unit weight Kg	Pieces	ITEM			
								Type	Dim. Hand	Fin.	Pers. Spec.

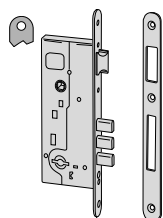

- Latch and 3 deadbolts
- SUPPLIED AS STANDARD: striker item 1.06279.12.0



1 00101 00 1

2	85	22	45	0,960	1	1	57290 45 0
2	85	22	50	1,030	1	1	57290 50 0
2	85	22	60	1,095	1	1	57290 60 0

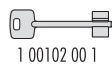

1 00102 00 1

2	85	22	45	0,960	1	1	57290 46 0
2	85	22	50	1,030	1	1	57290 51 0
2	85	22	60	1,085	1	1	57290 61 0

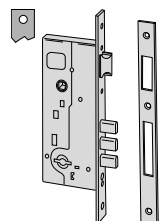

- Latch and 3 deadbolts
- SUPPLIED AS STANDARD: striker item 1.06278.11.0



1 00101 00 1

2	85	22	45	1,000	1	1	57291 45 0
2	85	22	50	1,030	1	1	57291 50 0
2	85	22	60	1,100	1	1	57291 60 0

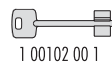

1 00102 00 1

2	85	22	45	0,960	1	1	57291 46 0
2	85	22	50	1,035	1	1	57291 51 0
2	85	22	60	0,960	1	1	57291 61 0

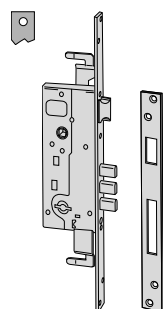

- Latch and 3 deadbolts
- Pre-set for additional locking points
- SUPPLIED AS STANDARD:
Two plates item 1.06085.00.0
Upper striker item 1.06084.00.0
striker item 1.06284.00.0
- ON REQUEST:
extension bolts item 1.06415.00.0
Floor striker item 1.06086.00.0

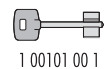

1 00101 00 1

2	85	25	45	1,340	1	1	57296 45 0
2	85	25	50	1,400	1	1	57296 50 0
2	85	25	60	1,435	1	1	57296 60 0



1 00102 00 1

2	85	25	45	1,396	1	1	57296 46 0
2	85	25	50	1,370	1	1	57296 51 0
2	85	25	60	1,450	1	1	57296 61 0



Technical features:

- Steel case and striker, painted in a metallized, antique bronze colour
- Nickel-plated steel latch
- Nickel-plated steel multiple deadbolts

Supplied as standard:

- Striker
- Outside escutcheon item 1.06043.00.0
- Inside escutcheon item 1.06458.11.0
- Fixing screws
- Instruction sheet

On request:

- Protective rose for item 1.06490.02.0 , 1.06490.02.0.B1
- Spacer item 1.06472.40.0

Hand:

1 = R.H. inwards

2 = L.H. inwards

Cylinder to be ordered separately



Type	Description	Key item	Throws	Backset	Unit weight 	Pieces 	ITEM			
							Type	Dim.	Hand	Fin.

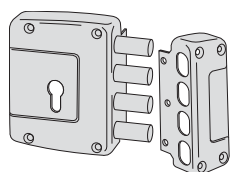

- 4 deadbolts only

2	64	2,120	1	1	56152	60	1
2	64	2,120	1	1	56152	60	2

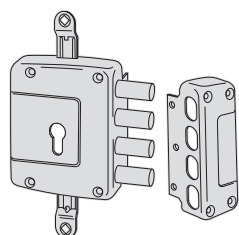

- 4 deadbolts only
- SUPPLIED AS STANDARD:
2 extension bolts item 1.06425.07.0
2 diverter item 1.06418.00.0

2	64	2,130	1	1	56162	60	1
2	64	2,130	1	1	56162	60	2

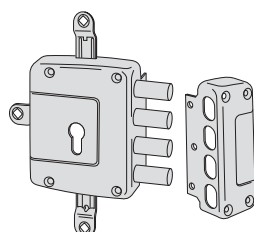

- 4 deadbolts only
- SUPPLIED AS STANDARD:
Secondary diverter case
- ON REQUEST:
Extension bolts item 1.06426.07.0
2 diverter item 1.06418.00.0

2	64	2,710	1	1	56172	60	1
2	64	2,710	1	1	56172	60	2

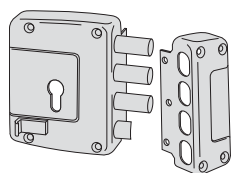

- Latch and 3 deadbolts
- Draw-back pull

2	64	2,120	1	1	56157	60	1
2	64	2,120	1	1	56157	60	2

Type	Description	Key item	Throws	Backset	Unit weight 	Pieces 	ITEM				
							Type	Dim.	Hand	Fin.	Pers. Spec.

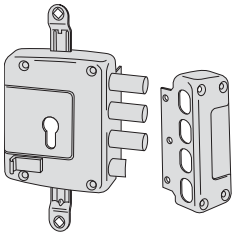

- Latch and 3 deadbolts
- Draw-back pull
- SUPPLIED AS STANDARD:
2 extension bolts item 1.06426.07.0
2 divertor item 1.06418.00.0

2	64	2,130	1	1	56167 60 1
2	64	2,130	1	1	56167 60 2

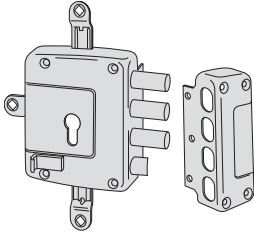

- Latch and 3 deadbolts
- Draw-back pull
- ON REQUEST:
2 extension bolts item 1.06425.07.0
2 divertor item 1.06418.00.0

2	64	2,710	1	1	56177 60 1
2	64	2,710	1	1	56177 60 2



Technical features:

- Steel case and striker, painted in a metallized, antique bronze colour
- Nickel-plated steel latch
- Nickel-plated steel multiple deadbolts
- External draw-back pull
- Picking resistant protection device on the latch lever
- External key guide

Hand:

- 1 = R.H. inwards
- 2 = L.H. inwards

Supplied as standard:

- Striker
- Outside escutcheon item 1.06140.00.0
- 3 keys:
 - item 1.00125.00.1 for hand 1
 - item 1.00125.00.2 for hand 2
- Fixing screws
- Instruction sheet



Type	Description	Key item	Throws	Backset	Unit weight	Pieces	ITEM			
							Type	Dim.	Hand	Fin.

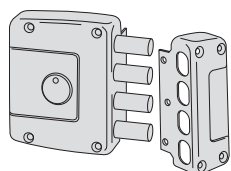

- 4 deadbolts only



1 00125 00 1/2

4	64	2,510	1	1	57152 60 1
4	64	2,510	1	1	57152 60 2

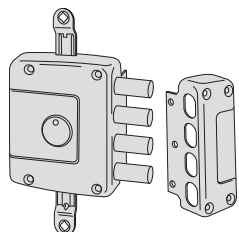

- 4 deadbolts only
- ON REQUEST:
 - 2 extension bolts item 1.06425.07.0
 - 2 divertor item 1.06418.00.0

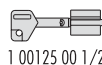

1 00125 00 1/2

4	64	2,520	1	1	57162 60 1
4	64	2,520	1	1	57162 60 2

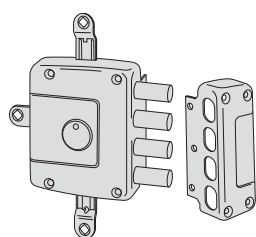

- 4 deadbolts only
- SUPPLIED AS STANDARD:
- Secondary divertor case
- ON REQUEST
 - 2 extension bolts item 1.06426.07.0
 - 2 divertor item 1.06418.00.0



1 00125 00 1/2

4	64	3,100	1	1	57172 60 1
4	64	3,100	1	1	57172 60 2

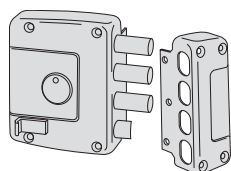

- Latch and 3 deadbolts
- Draw-back pull



1 00125 00 1/2

4	64	2,510	1	1	57157 60 1
4	64	2,510	1	1	57157 60 2

Type	Description	Key item	Throws	Backset	Unit weight 	Pieces 	ITEM				
							Type	Dim.	Hand	Fin.	Pers. Spec.

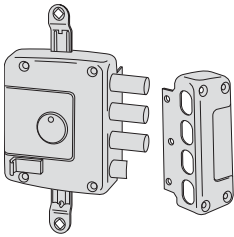

- Latch and 3 deadbolts
- Draw-back pull
- ON REQUEST:
2 extension bolts item 1.06426.07.0
2 divertor item 1.06418.00.0

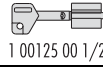

1 00125 00 1/2

4	64	2,520	1	1 57167 60 1
4	64	2,520	1	1 57167 60 2

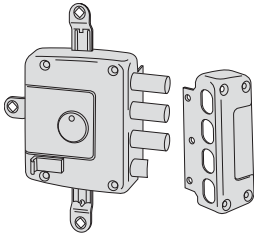

- Latch and 3 deadbolts
- Draw-back pull
- ON REQUEST:
2 extension bolts item 1.06425.07.0
2 divertor item 1.06418.00.0

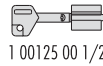

1 00125 00 1/2

4	64	3,100	1	1 57177 60 1
4	64	3,100	1	1 57177 60 2

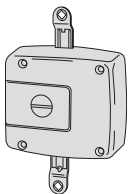

- Top and bottom locking
- Inside coin activated piece
- ON REQUEST:
2 extension bolts item 1.06425.07.0 (pc.2)

0,735	1	1 57192 00 0
-------	---	--------------



Technical features:

- Zinc-plated steel case
- Reversible flat latch with double chamfer, nickel-plated
- Nickel-plated deadbolt, either in a regular or multiple bolts configuration

Hand:

0 = Non-handed

Supplied as standard:

- Fixing screws for lock and striker
- Instruction sheet

Cylinder to be ordered separately



Type	Description	DEADBOLTS							ITEM			
		Latching points	Throws	Centre Distance	Faceplate	Backset	Unit weight	Pieces	Type	Dim.	Hand	Fin.

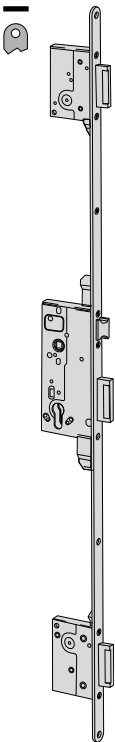

- bronze-plated steel 'flat' faceplate 22 x 3 mm., 1.600 mm.
- Latch-bolt and 3 lateral deadbolts
- ON REQUEST:
Set of bronze-plated strikers item 1.07174.00.0
bronze-plated striker item 1.06329.00.0
bronze-plated long lip item 1.06293.00.0



3	2	85	22	45	2,600	6	1	53002	45	0		
3	2	85	22	50	2,600	6	1	53002	50	0		
3	2	85	22	60	2,700	6	1	53002	60	0		

- Yellow zinc plated steel 'flat' faceplate 22 x 3 mm., 1.600 mm.
- Latch-bolt and 3 lateral deadbolts
- ON REQUEST:
Set of yellow zinc plated strikers item 1.07174.00.0.82
Yellow zinc plated striker item 1.06329.00.0.82
Brass long lip item 1.06293.01.0



3	2	85	22	45	3,420	6	1	53002	45	0	82	
3	2	85	22	50	3,420	6	1	53002	50	0	82	
3	2	85	22	60	3,420	6	1	53002	60	0	82	

- High-resistance zinc-plated flat faceplate 22x3 mm, 1600 mm.
- 3 lateral deadbolts
- ON REQUEST:
High-resistance zinc-plated strike plate set item 1.07174.00.0.B7
High-resistance zinc-plated strike plate item 1.06329.00.0.B7



3	2	85	22	45	3,000	6	1	53002	45	0	B7	
3	2	85	22	50	2,600	6	1	53002	50	0	B7	
3	2	85	22	60	2,700	6	1	53002	60	0	B7	

Type	Description	DEADBOLTS	Locking points	Throws	Centre Distance	Faceplate	Backset	Unit weight 	Pieces 	ITEM			
										Type	Dim.	Hand	Fin.

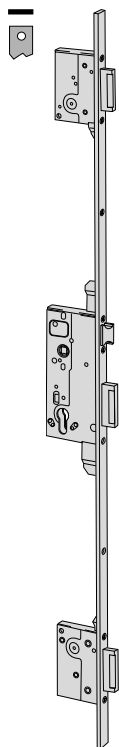

- bronze-plated steel 'flat' faceplate 22 x 3 mm., 1.600 mm.
- Latch-bolt and 3 lateral deadbolts
- ON REQUEST:
Set of bronze-plated strikers item 1.07175.00.0
bronze-plated striker item 1.06328.00.0
bronze-plated long lip item 1.06293.00.0

	3	2	85	22	45	2,600	6	1	53003 45 0
	3	2	85	22	50	4,000	6	1	53003 50 0
	3	2	85	22	60	4,000	6	1	53003 60 0

- Yellow zinc plated steel 'flat' faceplate 22 x 3 mm., 1.600 mm.
- Latch-bolt and 3 lateral deadbolts
- ON REQUEST:
Set of yellow zinc plated strikers item 1.07175.00.0.82
Yellow zinc plated striker item 1.06328.00.0.82
Brass long lip item 1.06293.01.0

	3	2	85	22	45	2,600	6	1	53003 45 0 82
	3	2	85	22	50	3,420	6	1	53003 50 0 82
	3	2	85	22	60	3,420	6	1	53003 60 0 82

- High-resistance zinc-plated flat faceplate 22x3 mm, 1600 mm.
- Latch and 3 lateral deadbolts
- ON REQUEST:
High-resistance zinc-plated strike plate set item 1.07175.00.0.B7
High-resistance zinc-plated strike plate item 1.06328.00.0.B7

	3	2	85	22	45	2,600	6	1	53003 45 0 B7
	3	2	85	22	50	4,000	6	1	53003 50 0 B7
	3	2	85	22	60	4,000	6	1	53003 60 0 B7

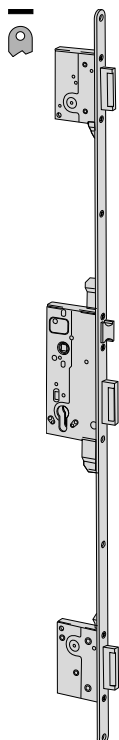

- Lacquered satin brass adjustable 'flat' faceplate 22 x 3 mm., 2.600 mm.
upper adjustment 650 mm.
lower adjustment 35 mm.
- Latch-bolt and 3 lateral deadbolts
- ON REQUEST:
Set of lacquered satin brass strikers item 1.07176.00.0
Set of long lipped lacquered satin brass strikers item 1.07176.10.0
Lacquered satin brass adjustable striker item 1.06330.00.0

	3	2	85	22	50	4,750	2	1	53035 50 0
	3	2	85	22	60	4,750	2	1	53035 60 0

Type	Description	DEADBOLTS	Locking points	Throws	Centre Distance	Faceplate	Backset	Unit weight 	Pieces 	ITEM				
										Type	Dim.	Hand	Fin.	Pers. Spec.

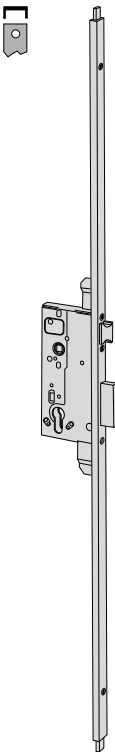

- Lacquered satin brass adjustable U-shaped faceplate
22 x 10 mm., 2.600 mm.
upper adjustment 650 mm.
lower adjustment 35 mm.
- Latch-bolt and central deadbolt
- Vertical extension bolts
- SUPPLIED AS STANDARD:
2 top strikers item 1.06292.00.0 and item 1.06292.01.0
1 floor striker item 1.06086.00.0
- ON REQUEST:
Lacquered satin brass striker item 1.06279.11.0
Long lipped lacquered satin brass striker item 1.06213.05.0
(2 pcs required)



3	2	85	22	45	4,750	2	1	53131	45	0
3	2	85	22	50	4,750	2	1	53131	50	0
3	2	85	22	60	4,750	2	1	53131	60	0

- Lacquered satin brass adjustable U-shaped faceplate
22 x 10 mm., 2.600 mm.
upper adjustment 650 mm.
lower adjustment 35 mm.
- Latch-bolt and central deadbolt
- Vertical extension bolts
- SUPPLIED AS STANDARD:
2 top strikers item 1.06292.00.0 and item 1.6292.01.0
1 floor striker item 1.06086.00.0
- ON REQUEST:
Lacquered satin brass striker item 1.06279.11.0
Long lipped lacquered satin brass striker item 1.06213.05.0
(2 pcs required)



3	2	85	22	45	4,750	2	1	53151	45	0
3	2	85	22	50	4,750	2	1	53151	50	0
3	2	85	22	60	4,750	2	1	53151	60	0

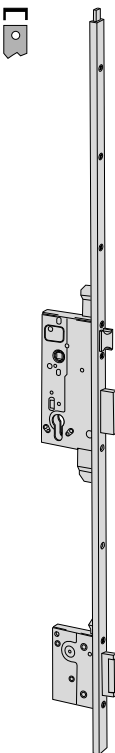

- Lacquered satin brass adjustable U-shaped faceplate
22 x 10 mm., 2.600 mm.
upper adjustment 650 mm.
lower adjustment 35 mm.
- Latch-bolt and 2 lateral deadbolts
- Top vertical extension bolt
- SUPPLIED AS STANDARD:
2 top strikers item 1.06292.00.0 and item 1.06292.01.0
- ON REQUEST:
Set of lacquered satin brass strikers item 1.07178.00.0
Set of long lipped lacquered satin brass strikers item 1.07178.10.0



3	2	85	22	45	3,900	2	1	53133	45	0
3	2	85	22	50	3,900	2	1	53133	50	0
3	2	85	22	60	3,900	2	1	53133	60	0

- Lacquered satin brass adjustable U-shaped faceplate
22 x 10 mm., 2.600 mm.
upper adjustment 650 mm.
lower adjustment 35 mm.
- Latch-bolt and 2 lateral deadbolts
- Top vertical extension bolt
- SUPPLIED AS STANDARD:
2 top strikers item 1.06292.00.0 and item 1.06292.01.0
- ON REQUEST:
Set of lacquered satin brass strikers item 1.07179.00.0
Set of long lipped lacquered satin brass strikers item 1.07179.10.0



3	2	85	22	50	3,900	2	1	53153	50	0
3	2	85	22	60	3,900	2	1	53153	60	0

Type	Description	DEADBOLTS	Locking points	Throws	Centre Distance	Faceplate	Backset	Unit weight 	Pieces 	ITEM			
										Type	Dim.	Hand	Fin.

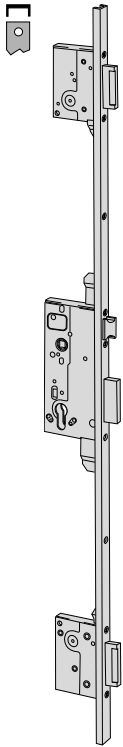

- Lacquered satin brass adjustable U-shaped faceplate
22 x 10 mm., 2.600 mm.
upper adjustment 650 mm.
lower adjustment 35 mm.
- Latch-bolt and 3 lateral deadbolts
- ON REQUEST:
Set of lacquered satin brass strikers item 1.07176.00.0
Set of long lipped lacquered satin brass strikers item
1.07176.10.0
Lacquered satin brass adjustable striker item 1.06330.00.0



3	2	85	22	45	4,750	2	1	53135 45 0
3	2	85	22	50	4,750	2	1	53135 50 0
3	2	85	22	60	4,750	2	1	53135 60 0

- Lacquered satin brass adjustable U-shaped faceplate
22 x 10 mm. 2.600 mm.
upper adjustment 650 mm.
lower adjustment 35 mm.
- Latch-bolt and 3 lateral deadbolts
- ON REQUEST:
Set of lacquered satin brass strikers item 1.07177.00.0
Set of long lipped lacquered satin brass strikers
item 1.07177.10.0
Lacquered satin brass adjustable striker item 1.06331.00.0



3	2	85	22	45	4,750	2	1	53155 45 0
3	2	85	22	50	4,750	2	1	53155 50 0
3	2	85	22	60	4,750	2	1	53155 60 0

Type	Description	DEADBOLTS	Locking points	Throws	Centre Distance	Faceplate	Backset	Unit weight 	Pieces 	ITEM			
										Type	Dim.	Hand	Fin.

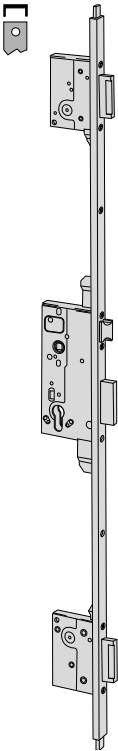

- Lacquered satin brass adjustable U-shaped faceplate
22 x 10 mm., 2.600 mm.
upper adjustment 650 mm.
lower adjustment 35 mm.
- Latch-bolt and 3 lateral deadbolts
- Vertical extension bolts
- SUPPLIED AS STANDARD:
2 upper strikers item 1.06292.00.0 and item 1.06292.01.0
1 floor striker item 1.06086.00.0
- ON REQUEST:
Set of lacquered satin brass strikers item 1.07176.00.0
Set of long lipped lacquered satin brass strikers
item 1.07176.10.0
Lacquered satin brass adjustable striker item 1.06330.00.0



5	2	85	22	45	3,900	2	1	53137	45	0
5	2	85	22	50	3,900	2	1	53137	50	0
5	2	85	22	60	3,900	2	1	53137	60	0

- Lacquered satin brass adjustable U-shaped faceplate
22 x 10 mm., 2.600 mm.
upper adjustment 650 mm.
lower adjustment 35 mm.
- Latch-bolt and 3 lateral deadbolts
- Vertical extension bolts
- SUPPLIED AS STANDARD:
2 upper strikers item 1.06292.00.0 and item 1.06292.01.0
1 floor striker item 1.06086.00.0
- ON REQUEST:
Set of lacquered satin brass strikers item 1.07177.00.0
Set of long lipped lacquered satin brass strikers
item 1.07177.10.0
Lacquered satin brass adjustable striker item 1.06331.00.0



5	2	85	22	45	4,750	2	1	53157	45	0
5	2	85	22	50	3,900	2	1	53157	50	0
5	2	85	22	60	4,750	2	1	53157	60	0



Technical features:

- Zinc-plated steel case
- Reversible flat latch with double chamfer, nickel-plated
- Nickel-plated deadbolt, either in a regular or multiple bolts configuration
- U shaped adjustable faceplate (22 x 10) in satin finish laquered brass, 2,600 mm. height
upper adjustment 650 mm.
lower adjustment 35 mm.

Hand:

0 = Non-handed

Supplied as standard:

- 3 keys
- Fixing screws for lock and striker
- Instruction sheet

Type	Description	DEADBOLTS	Key item	Locking points	Throws	Centre Distance	Faceplate	Backset	Unit weight	Pieces	ITEM			
											Type	Dim.	Hand	Fin.

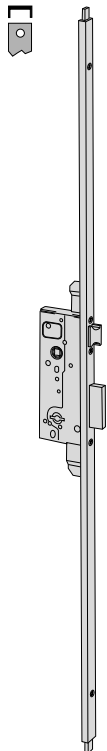

- Lacquered satin brass adjustable faceplate
- Latch-bolt and central deadbolt
- Vertical extension bolts
- SUPPLIED AS STANDARD:
2 top strikers item 1.06292.00.0 and item 1.06292.01.0
1 floor striker item 1.06086.00.0
1 Inside escutcheon item 1.06143.00.0
1 Outside escutcheon item 1.06082.00.0
- ON REQUEST:
Lacquered satin brass striker item 1.06279.11.0
Long lipped lacquered satin brass striker item 1.06213.05.0 (2 pcs. required)



1 00100 00 1

3	2	85	22	45	4,750	2	1	57831 45 0
3	2	85	22	50	4,750	2	1	57831 50 0
3	2	85	22	60	4,750	2	1	57831 60 0



1 00102 00 1

3	2	85	22	45	4,750	2	1	57831 46 0
3	2	85	22	50	4,750	2	1	57831 51 0
3	2	85	22	60	4,750	2	1	57831 61 0



1 00101 00 1

3	2	85	22	45	4,750	2	1	57851 45 0
3	2	85	22	50	4,750	2	1	57851 50 0
3	2	85	22	60	4,750	2	1	57851 60 0

- Lacquered satin brass adjustable faceplate
- Latch-bolt and central deadbolt
- Vertical extension bolts
- SUPPLIED AS STANDARD:
2 top strikers item 1.06292.00.0 and item 1.06292.01.0
1 floor striker item 1.06086.00.0
Escutcheons item 1.06144.10.0
- ON REQUEST:
Lacquered satin brass striker item 1.06279.11.0
Long lipped lacquered satin brass striker item 1.06213.05.0 (2 pcs. required)



1 00102 00 1

3	2	85	22	45	4,750	2	1	57851 46 0
3	2	85	22	50	4,750	2	1	57851 51 0
3	2	85	22	60	4,750	2	1	57851 61 0

Type	Description	DEADBOLTS	Key item	Locking points	Throws	Centre Distance	Faceplate	Backset	Unit weight 	Pieces 	ITEM			
											Type	Dim.	Hand	Fin.

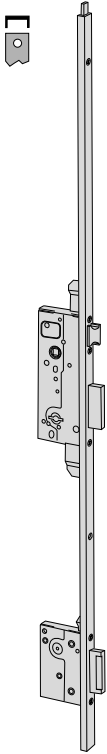

- Lacquered satin brass adjustable faceplate
- Latch-bolt and 2 lateral deadbolts
- Top vertical extension bolt
- SUPPLIED AS STANDARD:
2 top strikers item 1.06292.00.0 and item 1.06292.01.0
1 Inside escutcheon item 1.06143.00.0
1 Outside escutcheon item 1.06082.00.0
- ON REQUEST:
Set of lacquered satin brass strikers item 1.07178.00.0
Set of long lipped lacquered satin brass striker item 1.07178.10.0



3	2	85	22	45	4,750	2	1	57833	45	0
3	2	85	22	50	4,750	2	1	57833	50	0
3	2	85	22	60	4,750	2	1	57833	60	0

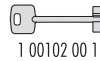

3	2	85	22	45	4,750	2	1	57833	46	0
3	2	85	22	50	4,750	2	1	57833	51	0
3	2	85	22	60	4,750	2	1	57833	61	0



3	2	85	22	45	4,750	2	1	57853	45	0
3	2	85	22	50	4,750	2	1	57853	50	0
3	2	85	22	60	4,750	2	1	57853	60	0

- Lacquered satin brass adjustable faceplate
- Latch-bolt and 2 lateral deadbolts
- Top vertical extension bolt
- SUPPLIED AS STANDARD:
2 top strikers item 1.06292.00.0 and item 1.06292.01.0
Escutcheons item 1.06144.10.0
- ON REQUEST:
Set of lacquered satin brass strikers item 1.07179.00.0
Set of long lipped lacquered satin brass striker item 1.07179.10.0

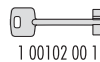

3	2	85	22	45	4,750	2	1	57853	46	0
3	2	85	22	50	4,750	2	1	57853	51	0

Type	Description	DEADBOLTS	Key item	Locking points	Throws	Centre Distance	Faceplate	Backset	Unit weight 	Pieces 	ITEM					
											Type	Dim.	Hand	Fin.	Pers.	Spec.
	<ul style="list-style-type: none"> Lacquered satin brass adjustable faceplate Latch-bolt and 3 lateral deadbolts SUPPLIED AS STANDARD: Inside escutcheon item 1.06143.00.0 Outside escutcheon item 1.06082.00.0 ON REQUEST: Set of lacquered satin brass strikers item 1.07176.00.0 Set of long lipped lacquered satin brass striker item 1.07176.10.0 Lacquered satin brass adjustable striker item 1.06330.00.0 		1 00100 00 1	3	2	85	22	45	4,750	2	1	57835	45	0		
				3	2	85	22	50	4,750	2	1	57835	50	0		
				3	2	85	22	60	4,750	2	1	57835	60	0		
					1 00102 00 1	3	2	85	22	45	4,750	2	1	57835	46	0
						3	2	85	22	50	4,750	2	1	57835	51	0
						3	2	85	22	60	4,750	2	1	57835	61	0
			<ul style="list-style-type: none"> Lacquered satin brass adjustable faceplate Latch-bolt and 3 lateral deadbolts SUPPLIED AS STANDARD: Escutcheons item 1.06144.10.0 ON REQUEST: Set of lacquered satin brass strikers item 1.07177.00.0 Set of long lipped lacquered satin brass striker item 1.07177.10.0 Lacquered satin brass adjustable striker item 1.06331.00.0 		1 00101 00 1	3	2	85	22	45	4,750	2	1	57855	45	0
						3	2	85	22	50	4,750	2	1	57855	50	0
						3	2	85	22	60	4,750	2	1	57855	60	0
					1 00102 00 1	3	2	85	22	45	4,750	2	1	57855	46	0
						3	2	85	22	50	4,750	2	1	57855	51	0
						3	2	85	22	60	4,750	2	1	57855	61	0



Technical features:









- Handles and protective roses in satin-finished AISI 304 stainless steel.
- Handle levers pre-mounted on mechanism with return spring.
- Fixed directly or using through screws on 38 to 54 mm thick doors. Fixing screws and square spindle provided

Certifications:

- Compliant with the European Standard EN 1906: 2012.
- Grade 3 - category of use (in places with high frequency of use)
- EN1906 - Grade 7 durability (200,000 cycles)
- EN1670 - Grade 2 corrosion resistance - 96 hours
- EN1634 - Fire resistance - 2 hours on wooden doors and 4 hours on metal doors

Project line

Type	Description	Throws	Centre Distance	Faceplate	Backset	Unit weight 	Pieces 	ITEM					
								Type	Dim. Hand	Fin.	Pers. Spec.		
	• Pair of handles PL Oval series					0,300	1	1	07070	70	0		
	• Pair of handles PL Oval series. • Supplied as standard: pair of protective roses for Euro profile cylinder					0,300	1	1	07070	80	0		
	• Pair of handles PL Angle series.					0,300	1	1	07070	71	0		
	• Pair of handles PL Angle series. • Supplied as standard: pair of protective roses for Euro profile cylinder.					0,300	1	1	07070	82	0		
	• Pair of handles PL Arcus series					0,300	1	1	07070	72	0		
	• Pair of handles PL Radius series.					0,300	1	1	07070	73	0		
	• Pair of handles PL Radius series. • Supplied as standard: pair of protective roses for Euro profile cylinder					0,300	1	1	07070	81	0		

Type	Description	Throws	Centre Distance	Faceplate	Backset	Unit weight 	Pieces 	ITEM						
								Type	Dim.	Hand	Fin.	Pers.	Spec.	
	• Pair of protective roses for Euro profile cylinders					0,070	1	1	06093	00	0			
	• Pair of solid protective roses					0,070	1	1	06093	01	0			
	• Pair of protective roses for Patent locks or similar					0,070	1	1	06093	02	0			
	• Pair of protective roses for Euro profile cylinders					0,070	1	1	06093	04	0			
	• Thumb turn for bathroom doors.					0,070	1	1	06093	10	0			
	• Thumb turn for bathroom doors WITH vacant/engaged indicator.					0,090	1	1	06093	11	0			

Type	Description	For series/item	Unit weight Pieces	ITEM			
				Type	Dim.	Hand	Fin.
	<ul style="list-style-type: none"> Angular non-handed brass striker 	12010, 12011	0,110 6	1	06035	00	0
	<ul style="list-style-type: none"> Brass push-button ON REQUEST: Nichel plated brass (fin. 12) 	12010, 12011, 12015, 12016	0,037 6	1	06110	00	0
	<ul style="list-style-type: none"> Angular non-handed brass striker 	12015, 12016	0,163 6	1	06218	00	0
	<ul style="list-style-type: none"> Nylon contact set complete with spacers: 2 mm. (Pcs. 4) 	11000, 12000, 13000	0,035 6	1	06510	00	0
	<ul style="list-style-type: none"> Coil set 12 V ac 	12010, 12011, 12015, 12016	0,051 6	1	07009	00	0
	<ul style="list-style-type: none"> Coil set 12 V ac 	13010	0,071 6	1	07012	00	0
	<ul style="list-style-type: none"> Gray lacquered steel striker with roller 	11610, 11611, 11630, 11631	0,178 6 0,178 6	1	07017	10	1 2

Type	Description	For series/item	Unit weight Kg	Pieces	ITEM				
					Type	Dim.	Hand	Fin.	Pers. Spec.
	<ul style="list-style-type: none"> • Striker 	1A610, 1A611, 1A630, 1A631	0,200	6	1	07021	10	0	
	<ul style="list-style-type: none"> • 1 mm spacer for striker 	1A610, 1A611, 1A630, 1A631	0,025	12	1	07021	11	0	
	<ul style="list-style-type: none"> • Striker set including: slide anchoring plate screws 	11610, 11921, 11931	0,100 0,100	1 1	1	07018	10	3 4	
	<ul style="list-style-type: none"> • Gray lacquered steel striker with roller 	11670, 11671	0,210 0,210	6 6	1	07019	10	1 2	
	<ul style="list-style-type: none"> • Coil set • 12 V ac • Black nylon support 	11610, 11611, 11630, 11631, 11670, 11671, 11721, 11731, 11761, 11771, 11823, 11921, 11931	0,087 0,087	6 6	1	07118	00	1 2	
	<ul style="list-style-type: none"> • Coil set • 24 V ac • Black nylon support 	11610, 11611, 11630, 11631, 11670, 11671, 11721, 11731, 11761, 11771, 11823, 11921, 11931	0,075 0,082	6 6	1	07118	01	1 2	

Type	Description	For series/item	Unit weight Pieces	ITEM				
				Type	Dim.	Hand	Fin.	Pers. Spec.
	<ul style="list-style-type: none"> Adjustable coil set 12 V ac Blue nylon support 	11610,11611,	0,075	6	1	07120	00	1
		11630,11631,	0,074	6	1	07120	00	2
	<ul style="list-style-type: none"> Adjustable coil set 24 V ac Blue nylon support 	11670,11671,						
		11721,11731,						
		11761,11771,						
		11823,11921,						
		11931						
		11610,11611,	0,075	6	1	07120	01	1
		11630,11631,	0,075	6	1	07120	01	2
		11670,11671,						
		11721,11731,						
		11761,11771,						
		11823,11921,						
		11931						
	<ul style="list-style-type: none"> Coil set 12V ac CE 	1A610,1A611,	0,092	6	1	07025	00	0
		1A630,1A631,						
		1A721,1A731						

Type	Description	For series/item	Unit weight Kg	Pieces	ITEM				
					Type	Dim.	Hand	Fin.	Pers.
	<ul style="list-style-type: none"> • Metalized aluminium spacer set 	54570, 57580	0,180	6	1	06091	10	0	
	<ul style="list-style-type: none"> • Amaranth red lacquered steel striker 	50110, 50111,	0,104	6	1	07024	00	1	
		50115, 50120,	0,090	6	1	07024	00	2	
		50121, 50150,							
		50151, 50160,							
		50170, 50171,							
		50180, 50181							

Type	Description	For series/item	Unit weight Pieces	ITEM			
				Type	Dim.	Hand	Fin.
	<ul style="list-style-type: none"> Long lipped, brass plated steel striker with round corners TO BE DISCONTINUED 	5C031, 5C130, 5C631, 5C671	0,049 25				1 06098 00 0
	<ul style="list-style-type: none"> Brass plated steel striker with round corners 	5C631, 5C641, 5C671	0,087 25				1 06100 10 0
	<ul style="list-style-type: none"> Brass plated striker with round corners 	5C140	0,096 25				1 06100 15 0
	<ul style="list-style-type: none"> Long lipped, brass plated steel striker with round corners 	52641	0,056 25				1 06101 10 0
	<ul style="list-style-type: none"> Long lipped, brass plated steel striker 	52621	0,058 25				1 06102 10 0
	<ul style="list-style-type: none"> Long lipped, brass striker 	5C110	0,057 25				1 06102 13 0
	<ul style="list-style-type: none"> Long lipped, brass striker 	52300	0,040 25				1 06107 00 0
	<ul style="list-style-type: none"> Long lipped, brass striker 	5C120	0,055 25				1 06149 00 0
	<ul style="list-style-type: none"> Long lipped, brass plated steel striker with round corners 	52031	0,090 25				1 06150 00 0
	<ul style="list-style-type: none"> Long lipped, brass plated steel striker 	52011	0,052 25				1 06152 00 0

Type	Description	For series/item	Unit weight Pieces	ITEM		
				Type	Dim.	Hand
	• Long lipped, brass plated steel striker	5C021	0,550 25	1	06162	00 0
	• Long lipped brass striker	52010	0,055 25	1	06163	00 0
	• Brass plated steel striker	5C120, 5C611, 5C621, 5C651	0,074 25	1	06206	00 0
	• Long lipped brass striker	5C130, 5C170, 53131, 53151, 57831, 57851	0,055 25	1	06213	05 0
	• Brass striker	5C110	0,062 25	1	06216	00 0
	• Long lipped brass plated steel striker	5C110, 5C611, 5C651	0,050 25	1	06223	00 0
	• Brass plated steel striker	5C110, 5C611, 5C651	0,053 25	1	06226	00 0
	• Brass plated steel striker with round corners	5C130, 5C631, 5C671	0,098 25	1	06243	00 0
	• Polished, chrome-plated satin-finished external ring	1 06460 05 0, 1 06460 06 0	0,025 12	1	06473	60 0



Type	Description	For series/item	Unit weight Pieces	ITEM				
				Type	Dim.	Hand	Fin.	Pers. Spec.
	<ul style="list-style-type: none"> • Brass striker 	52210, 52310	0,025	25	1	07032	00	0
	<ul style="list-style-type: none"> • Protective rose for cylinder series RS3, ASTRAL (with long key CL) and ASIX, in polished golden finish carbonitrided steel • Complete with: Spacers 2 mm. (pcs.19), 1 mm. (pcs. 2) Outside cover plates 2 mm. (pcs.2) Screws M5 x 73 mm. Inner rose 	12000, 52000, 53000	0,500	1	1	06460	15	0
	<ul style="list-style-type: none"> • Carbonitrided steel protection rose with polished brass finish • 2 screws (M6) • AVAILABLE FINISHES: Anodised light bronze (fin. 65) Anodised dark bronze (fin. 64) Polished chrome (fin. 18) 	0A310, 0B310, 08310, 08710	0,310	1	1	06460	50	0
	<ul style="list-style-type: none"> • Carbonitrided steel rotor protection for roses series 06460 and 06461 	0A310, 0B310, 08310, 08510, 08710	0,009	50	1	06460	01	0

Type	Description	For series/item	Unit weight Kg	Pieces	ITEM			
					Type	Dim.	Hand	Fin.
	<ul style="list-style-type: none"> • Inside brass escutcheon 	57000	0,035	12	1	06081	00	0
	<ul style="list-style-type: none"> • Outside brass escutcheon 	1 06119 00 0, 1 06142 00 0, 57000	0,030	12	1	06082	00	0
	<ul style="list-style-type: none"> • Hollow outside brass escutcheon 	1 06119 00 0, 1 06142 00 0, 57000	0,031	12	1	06083	00	0
	<ul style="list-style-type: none"> • Top steel striker 	52526, 56015, 56020, 56255, 57015, 57020, 57024, 57033, 57215, 57217, 57255, 57296	0,028	12	1	06084	00	0
	<ul style="list-style-type: none"> • Brass floor striker diameter 11 mm. • FOR: extension bolts with rods diameter 10 mm 	1 06415 00 0, 1 06441 15 0, 1 07088 03 0, 1 07088 04 0, 43090, 43190, 43690, 46445, 52526, 53131, 53137, 53151, 53157, 56255, 57015, 57019, 57020, 57024, 57033, 57055, 57215, 57217, 57255, 57259, 57265, 57296, 57831, 57837, 57851, 57857	0,016	12	1	06086	00	0

Type	Description	For series/item	Unit weight Pieces	ITEM		
				Type	Dim.	Hand
	<ul style="list-style-type: none"> • Brass floor striker with spring dust-cover, diameter 12 mm. • USED FOR: Internal extension bolts with 8 and 10 mm. diameter rods multi-point locks series 46445 extension bolt for Multitop item 1.06449.11.0 		0,020 12	1	06086	02 0
	<ul style="list-style-type: none"> • Nylon key guide, with eight spacers 	57000	0,050 12	1	06142	00 0
	<ul style="list-style-type: none"> • Inside brass escutcheon with plug 	57000	0,032 12	1	06143	00 0
	<ul style="list-style-type: none"> • Nickel-plated steel striker 	57010	0,117 25	1	06231	00 0
	<ul style="list-style-type: none"> • Nickel-plated steel striker 	57015, 57020, 57220, 57225, 57230	0,124 25	1	06235	00 0
	<ul style="list-style-type: none"> • Nickel-plated steel striker 	56250, 57250	0,126 25	1	06271	00 0
	<ul style="list-style-type: none"> • Nickel-plated steel striker 	56255, 57215, 57255	0,131 25	1	06272	00 0
	<ul style="list-style-type: none"> • Long lipped nickel-plated steel striker 	56255, 57255	0,146 25	1	06275	00 0
	<ul style="list-style-type: none"> • Nickel-plated steel striker 	57211	0,100 12	1	06278	00 0

Type	Description	For series/item	Unit weight Kg	Pieces	ITEM				
					Type	Dim.	Hand	Fin.	Pers. Spec.
	• Lacquered brass plated satin steel striker	52521, 57291	0,120	12	1	06278	11	0	
	• Nickel-plated steel striker with round corners	57210	0,096	12	1	06279	00	0	
	• Lacquered brass plated satin steel striker with round corners	52520, 57290	0,120	12	1	06279	12	0	
	• Long lipped nickel-plated steel striker	57211, 57215	0,145	25	1	06281	00	0	
	• Nickel-plated steel striker	57220	0,079	25	1	06282	00	0	
	• Lacquered brass plated steel striker	1 57028 60 0	0,100	12	1	06283	01	0	
	• Lacquered brass plated steel striker	56010, 56015, 56020	0,100	12	1	06283	02	0 B7	
	• Lacquered brass plated steel striker	52526, 57260, 57265, 57296	0,131	25	1	06284	00	0	
	• Long lipped lacquered brass plated steel striker TO BE DISCONTINUED	57260, 57265	0,140	25	1	06284	01	0	
	• Zinc plated steel saw resistant tip, 10 mm. • Side push resistance KN 15	1 06415 00 0, 1 06416 00 0, 1 06441 15 0	0,056	12	1	06291	00	0	

Type	Description	For series/item	Unit weight Pieces	ITEM				
				Type	Dim.	Hand	Fin.	Pers. Spec.
	<ul style="list-style-type: none"> • Zinc plated hardened steel tip, dia. 10 mm. • Side push resistance KN 25 	1 06415 00 0, 1 06416 00 0, 1 06441 15 0, 1 07088 03 0	0,054	12	1 06291 05 0			
	<ul style="list-style-type: none"> • Zinc plated steel pin connector 	1 06415 00 0, 1 06416 00 0, 1 06441 00 0, 1 06441 10 0, 1 06441 15 0, 1 06441 20 0, 1 06451 00 0, 1 06451 10 0, 1 07088 00 0, 1 07088 03 0	0,016	12	1 06291 20 0			
	<ul style="list-style-type: none"> • Zinc plated extension bolts • SUPPLIED AS STANDARD: • Pair of bolts dia. 8 mm. • Pair of tips dia. 10 mm. item 1.06291.05.0 (2 pieces) 	52526, 56015, 56016, 56255, 57015, 57016, 57019, 57033, 57035, 57055, 57215, 57217, 57225, 57226, 57255, 57256, 57259, 57265, 57296, 57318, 57336	0,533	12	1 06415 00 0			
	<ul style="list-style-type: none"> • Zinc plated extension bolt • SUPPLIED AS STANDARD: • Bolt dia. 8 mm. • Pair of tips dia. 10 mm. item 1.06291.05.0 (2 pieces) 	56020, 57020, 57024, 57230	0,350	10	1 06416 00 0			

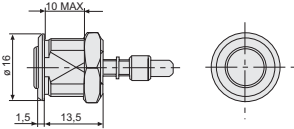
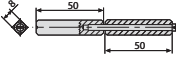
Type	Description	For series/item	 Unit weight Kg	 Pieces	ITEM				
					Type	Dim.	Hand	Fin.	Pers. Spec.
	<ul style="list-style-type: none"> Indicator of occupancy 	52842, 52844, 52862, 52864	0,015	6	1	06146	00	0	
	<ul style="list-style-type: none"> Split follower 	52760, 52761, 52844, 52864	0,047	25	1	07206	01	0	

Type	Description	For series/item	Unit weight 	Pieces 	ITEM				
					Type	Dim.	Hand	Fin.	Pers. Spec.
	<ul style="list-style-type: none"> Polished brass protective rose for use with Euro profile cylinders 		0,024	100	1	06043	00	0	
	<ul style="list-style-type: none"> Outside brass escutcheon 	56152, 56157, 56162, 56167, 56172, 56177, 57152, 57157, 57162, 57167, 57172, 57177	0,029	12	1	06140	00	0	
	<ul style="list-style-type: none"> Hollow outside brass escutcheon A = 10, door thickness 60 mm. 	56152, 56157, 56162, 56167, 56172, 56177, 57152, 57157, 57162, 57167, 57172, 57177	0,032	12	1	06140	01	0	
	<ul style="list-style-type: none"> Hollow outside brass escutcheon A = 22, door thickness 70 mm. 	56152, 56157, 56162, 56167, 56172, 56177, 57152, 57157, 57162, 57167, 57172, 57177	0,037	12	1	06140	02	0	
	<ul style="list-style-type: none"> Bronze lacquered steel top striker 	56162, 56167, 56172, 56177, 57162, 57167, 57172, 57177, 57192	0,100	12	1	06236	00	0	
	<ul style="list-style-type: none"> Brass floor striker with sprung dust cover 	56162, 56167, 56172, 56177, 57162, 57167, 57172, 57177, 57192	0,028	12	1	06237	01	0	
	<ul style="list-style-type: none"> Set of bronze lacquered steel divertor 	56162, 56167, 56172, 56177, 57162, 57167, 57172, 57177, 57192	0,029	12	1	06418	00	0	

Type	Description	For series/item	Unit weight Kg	Pieces	ITEM				
					Type	Dim.	Hand	Fin.	Pers.
	<ul style="list-style-type: none"> • Bronze lacquered steel bar guide 	56162, 56167, 56172, 56177, 57162, 57167, 57172, 57177, 57192	0,030	24	1	06422	00	0	
	<ul style="list-style-type: none"> • Bronze lacquered steel long adjustable extension bolt 	56162, 56167, 56172, 56177, 57162, 57167, 57172, 57177, 57192	0,766	6	1	06424	00	0	
	<ul style="list-style-type: none"> • Complete set of bolt extension rods for locks with 3 locking points • SUPPLIED AS STANDARD: <ul style="list-style-type: none"> - Set of bolt extension rods - Top strike item 1.06236.00.0 - Floor strike item 1.06237.00.0 - 2 rod guide clips item 1.06422.00.0 	56162, 56167, 57162, 57167, 57192	1,500	1	1	06425	07	0	
	<ul style="list-style-type: none"> • Complete set of bolt extension rods for locks with 5 locking points • SUPPLIED AS STANDARD: <ul style="list-style-type: none"> - 2 sets of top/bottom bolt extension rods - 2 top strikes item 1.06236.00.0 - 2 floor strikes item 1.06237.00.0 - 4 rod guide clips item 1.06422.00.0 	56172, 56177, 57172, 57177	3,300	1	1	06426	07	0	
	<ul style="list-style-type: none"> • Inside aluminium escutcheon painted in metallic antique bronze colour 		0,036	12	1	06458	11	0	
	<ul style="list-style-type: none"> • Bronze lacquered steel striker 	56152, 56157, 56162, 56167, 56172, 56177, 57152, 57157, 57162, 57167, 57172, 57177	0,320	2	1	07054	00	0	
	<ul style="list-style-type: none"> • Bronze lacquered steel top striker 	56152, 56157, 56162, 56167, 56172, 56177, 57152, 57157, 57162, 57167, 57172, 57177	0,442	2	1	07055	00	0	

Type	Description	For series/item	Unit weight Pieces	ITEM				
				Type	Dim.	Hand	Fin.	Pers. Spec.
	<ul style="list-style-type: none"> Nickel-plated steel screw 	1 06119 00 0, 1 06123 00 1, 1 06123 03 0, 1 06123 04 0, 1 06142 00 0, 1 06142 02 0	0,006	50	1	06048 02 0		
	<ul style="list-style-type: none"> Nickel-plated steel screw 	1 06119 00 0, 1 06123 00 1, 1 06123 03 0, 1 06123 04 0, 1 06142 00 0, 1 06142 02 0	0,008	50	1	06048 03 0		
	<ul style="list-style-type: none"> Inside brass escutcheon 	57000	0,035	12	1	06081 00 0		
	<ul style="list-style-type: none"> Outside brass escutcheon 	1 06119 00 0, 1 06142 00 0, 57000	0,030	12	1	06082 00 0		
	<ul style="list-style-type: none"> Hollow outside brass escutcheon 	1 06119 00 0, 1 06142 00 0, 57000	0,031	12	1	06083 00 0		
	<ul style="list-style-type: none"> Polished brass key guide escutcheon with ten spacers AVAILABLE FINISHES: Bronze anodised aluminium (fin. 47) Chrome-plated brass (fin.18) 	57000	0,094	5	1	06119 00 0		
	<ul style="list-style-type: none"> Inside brass escutcheon with plug 	57000	0,032	12	1	06143 00 0		

Type	Description	For series/item	Unit weight Kg	Pieces	ITEM				
					Type	Dim.	Hand	Fin.	Pers. Spec.
	<ul style="list-style-type: none"> Polished brass rose with key guide For double bitted locks AVAILABLE FINISHES: Polished chrome (fin.18) Anodised light bronze (fin.65) Anodised dark bronze (fin.64) Polished chrome plated (Fin B1) 		0,105	6	1	06144	10	1	
	<ul style="list-style-type: none"> Nylon key guide, including 2 supports for escutcheon and 3 spacers For double bit key locks 		0,066	6	1	06144	15	0	
	<ul style="list-style-type: none"> Polished brass cover for escutcheon and key guide AVAILABLE FINISHES: Polished chrome (fin.18) Anodised light bronze (fin.65) Anodised dark bronze (fin.64) Polished chrome plated (Fin B1) 	1 06144 10 1, 1 06144 15 0	0,030	50	1	06144	50	1	
	<ul style="list-style-type: none"> Brass long lipped striker 	5C130, 5C170, 53131, 53151, 57831, 57851	0,055	25	1	06213	05	0	
	<ul style="list-style-type: none"> bronze-plated steel central striker Yellow zinc plated steel central striker 	53002 53002	0,100	12	1	06279	10	0	
	<ul style="list-style-type: none"> Lacquered satin brass central striker 	5C130, 5C170, 53035, 53131, 53133, 53135, 53137, 53151, 53153, 53155, 53157, 57831, 57833, 57835, 57851, 57853, 57855	0,096	12	1	06279	11	0	
	<ul style="list-style-type: none"> Brass upper striker (single-leaf doors) 	53131, 53133, 53137, 53151, 53153, 53157, 57831, 57833, 57851, 57853	0,060	12	1	06292	00	0	

Type	Description	For series/item	Unit weight Kg	Pieces	ITEM				
					Type	Dim.	Hand	Fin.	Pers. Spec.
	<ul style="list-style-type: none"> • Brass upper striker (double-leaf doors) 	53131, 53133, 53137, 53151, 53153, 53157, 57831, 57833, 57851, 57853	0,060	12	1	06292	01	0	
	<ul style="list-style-type: none"> • Long lip in bronze-plated brass for central strikers • Long lip in lacquered satin brass for central strikers 	53002, 53003	0,040	25	1	06293	00	0	
	<ul style="list-style-type: none"> • Top and bottom striker in bronze-plated steel, for lateral deadbolts 	53003	0,100	12	1	06322	00	0	
	<ul style="list-style-type: none"> • Top and bottom striker in bronze-plated steel, for lateral deadbolts • Top and bottom striker in yellow zinc plated steel, for lateral deadbolts • Top and bottom striker in lacquered satin brass, for lateral deadbolts 	53002, 53002, 53035, 53133, 53135, 53137, 57833, 57835	0,100	12	1	06323	00	0	82
	<ul style="list-style-type: none"> • Top and bottom striker in lacquered satin brass, for lateral deadbolts 	53153, 53155, 53157, 57853, 57855	0,120	12	1	06325	00	0	
	<ul style="list-style-type: none"> • Square striker (1.600 mm.) in bronze-plated steel • Square striker (1.600 mm.) in yellow zinc plated steel • Square strike plate (1600 mm.) in high resistance zinc-plated steel 	53003, 53003, 53003	0,800	6	1	06328	00	0	82
	<ul style="list-style-type: none"> • Round striker (1.600 mm.) in bronze-plated steel • Round striker (1.600 mm.) in yellow zinc plated steel 	53002, 53002	0,800	6	1	06329	00	0	82
			0,800	6	1	06329	00	0	B7

Type	Description	For series/item	Unit weight Kg	Pieces	ITEM				
					Type	Dim.	Hand	Fin.	Pers. Spec.
	<ul style="list-style-type: none"> Adjustable striker in lacquered satin brass 	53035, 53135, 53137, 53155, 53157, 57835, 57837, 57855, 57857	1,300	6	1	06331	00	0	
	<ul style="list-style-type: none"> Protective rose for cylinder series RS3, ASTRAL (with long key CL) and ASIX, in polished golden finish carbonitrited steel Complete with: Spacers 2 mm. (pcs.19), 1 mm. (pcs. 2) Outside cover plates 2 mm. (pcs.2) Screws M5 x 73 mm. Inner rose 	12000, 52000, 53000	0,500	1	1	06460	15	0	
	<ul style="list-style-type: none"> Set of vertical extension bolts including 2 upper strikers (flat, square) and 1 floor striker 	53000, 57000	0,533	1	1	07173	00	0	
	<ul style="list-style-type: none"> Set of bronze-plated steel strikers: pcs. 1 item 1.06279.10.0 pcs 2 item 1.06323.00.0 	53002	0,266	6	1	07174	00	0	
	<ul style="list-style-type: none"> Set of yellow zinc plated steel strikers: pcs. 1 item 1.06279.10.0.82 pcs. 2 item 1.06323.00.0.82 	53002	0,180	6	1	07174	00	0	82
	<ul style="list-style-type: none"> High resistance zinc-plated steel strike plate set: 1 pc central strike 2 pcs side deadbolt strike 	53002	0,266	6	1	07174	00	0	87

Type	Description	For series/item	Kg	Pieces	ITEM	Type	Dim.	Hand	Fin.	Pers.	Spec.
	<ul style="list-style-type: none"> • Set of bronze-plated steel strikers: pcs. 1 item 1.06278.10.0 pcs. 2 item 1.06322.00.0 	53003	0,300	6	1 07175 00 0						
	<ul style="list-style-type: none"> • Set of yellow zinc plated steel strikers: pcs. 1 item 1.06278.10.0.82 pcs. 2 item 1.06322.00.0.82 	53003	0,300	6	1 07175 00 0 82						
	<ul style="list-style-type: none"> • High resistance zinc-plated steel strike plate set: pz. 1 item 1.06278.10.0.B7 pz. 2 item 1.06322.00.0.B7 	53003	0,300	6	1 07175 00 0 B7						
	<ul style="list-style-type: none"> • Set of lacquered satin brass strikers: pcs. 1 item 1.06279.11.0 pcs. 2 item 1.06323.01.0 	53035, 53135, 53137, 57835	0,300	6	1 07176 00 0						
	<ul style="list-style-type: none"> • Set of lacquered satin brass strikers: pcs. 2 item 1.06213.05.0 pcs. 2 item 1.06323.01.0 	53035, 53135, 53137, 57835	0,300	6	1 07176 10 0						
	<ul style="list-style-type: none"> • Set of lacquered satin brass strikers: pcs. 1 item 1.06279.11.0 pcs. 2 item 1.06325.00.0 	53155, 53157, 57855	0,275	6	1 07177 00 0						
	<ul style="list-style-type: none"> • Set of lacquered satin brass strikers: pcs. 2 item 1.06213.05.0 pcs. 2 item 1.06325.00.0 	53155, 53157, 57855	0,300	6	1 07177 10 0						

Type	Description	For series/item	Unit weight Kg	Pieces	ITEM				
					Type	Dim.	Hand	Fin.	Pers.
	<ul style="list-style-type: none"> Set of lacquered satin brass strikers: pcs. 1 item 1.06279.11.0 pcs. 1 item 1.06323.01.0 	53133, 57833	0,192	6	1	07178	00	0	
	<ul style="list-style-type: none"> Set of lacquered satin brass strikers: pcs. 2 item 1.06213.05.0 pcs. 1 item 1.06323.01.0 	53133, 57833	0,200	6	1	07178	10	0	
	<ul style="list-style-type: none"> Central cylinder lock with latch-bolt and flat-type deadbolt 	53002, 53003, 53035, 53131, 53133, 53135, 53137	0,770 0,800 0,860	1	1	52507	45	0	
	<ul style="list-style-type: none"> Central cylinder lock with roller latch and flat-type deadbolt 	53002, 53003, 53035, 53131, 53133, 53135, 53137	1,145 0,770 1,145	1	1	52508	45	0	
	<ul style="list-style-type: none"> Central cylinder lock with latch-bolt and pin-operated deadbolt 	53151, 53153, 53155, 53157	0,735 0,765 0,800	1	1	52527	45	0	
	<ul style="list-style-type: none"> Central cylinder lock with roller latch and pin-operated deadbolt 	53151, 53153, 53155, 53157	0,700 0,700 0,805	1	1	52528	45	0	

Type	Description	For series/item	Unit weight Pieces	ITEM			
				Type	Dim.	Hand	Fin.
	<ul style="list-style-type: none"> • Double bit key central lock with latch-bolt and flat-type deadbolt • 3 key blanks item 1.00100.00.1 	57831, 57833,	0,845	1	1	57218 45 0	
		57835	0,870	1	1	57218 50 0	
			0,925	1	1	57218 60 0	
	<ul style="list-style-type: none"> • Double bit key central lock with latch-bolt and flat-type deadbolt • 3 key blanks item 1.00102.00.1 	57831, 57833,	0,850	1	1	57218 46 0	
		57835	0,880	1	1	57218 51 0	
			0,940	1	1	57218 61 0	
	<ul style="list-style-type: none"> • Double bit key central lock with roller latch and flat-type deadbolt • 3 key blanks item 1.00100.00.1 	57831, 57833,	1,340	1	1	57219 45 0	
		57835	1,340	1	1	57219 50 0	
	<ul style="list-style-type: none"> • Double bit key central lock with latch-bolt and pin-operated deadbolt • 3 key blanks item 1.00100.00.1 	57851, 57853,	1,340	1	1	57298 45 0	
		57855	0,845	1	1	57298 50 0	
			0,910	1	1	57298 60 0	
	<ul style="list-style-type: none"> • Double bit key central lock with latch-bolt and pin-operated deadbolt • 3 key blanks item 1.00102.00.1 	57851, 57853,	1,340	1	1	57298 46 0	
		57855	1,340	1	1	57298 51 0	
			1,340	1	1	57298 61 0	
	<ul style="list-style-type: none"> • Double bit key central lock with roller latch and pin-operated deadbolt • 3 key blanks item 1.00100.00.1 	57851, 57853,	0,950	1	1	57299 45 0	
		57855	0,815	1	1	57299 50 0	
			0,875	1	1	57299 60 0	

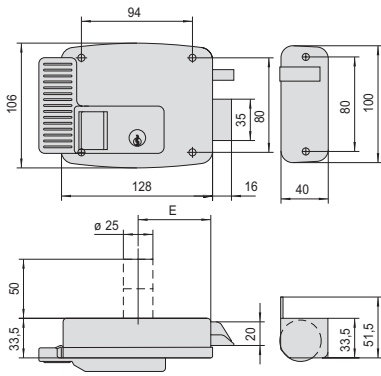

11611-11631

E = 50 - 60 - 70 - 80

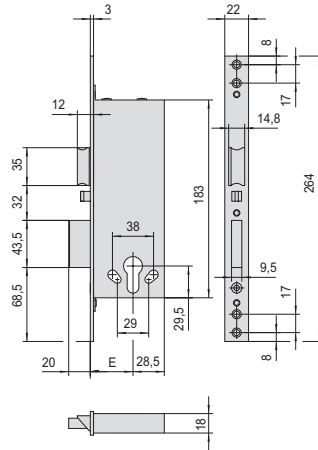

12010, 12011, 12015, 12016
E = 40 - 50 - 60 - 70

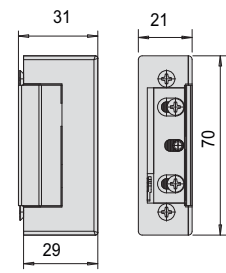

15100, 15101, 15102,
15110, 15120, 15121,
15122, 15130, 15140
15150, 15160, 15170,
15180

8

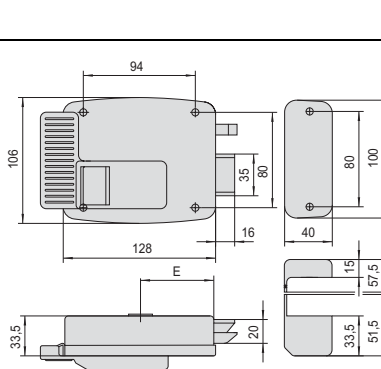

11610 - 11630

E = 50 - 60 - 70 - 80

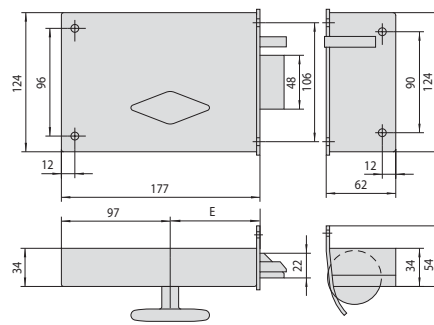

13010
E = 60 - 70 - 80 - 90 - 100 - 110 - 120

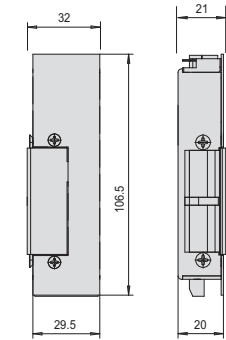

15200

9

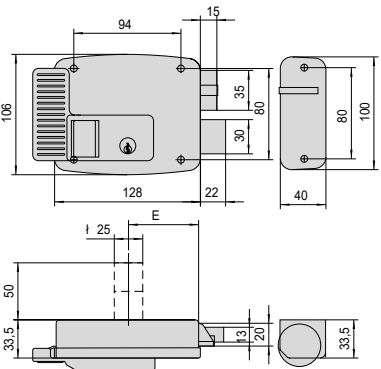

11670, 11671, 11671, 11771

E = 50 - 60 - 70 - 80

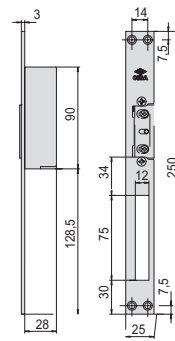

1.15001.00

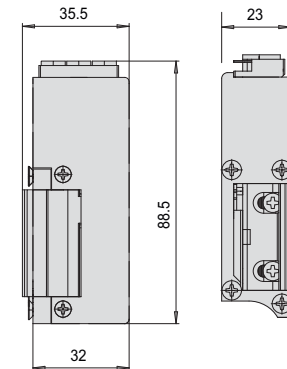

15300

10

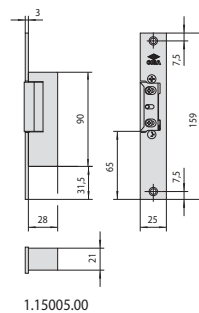
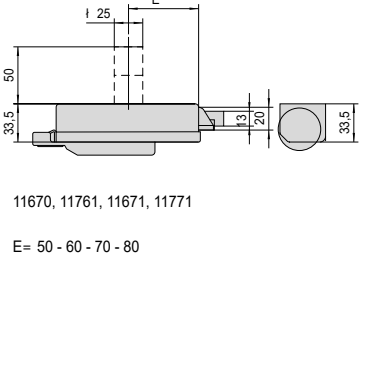

1.15005.00

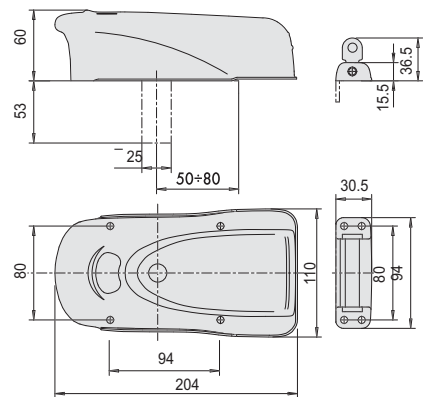

1A610, 1A611, 1A630, 1A631, 1A721, 1A731

11

1

2

3

4

5

6

7

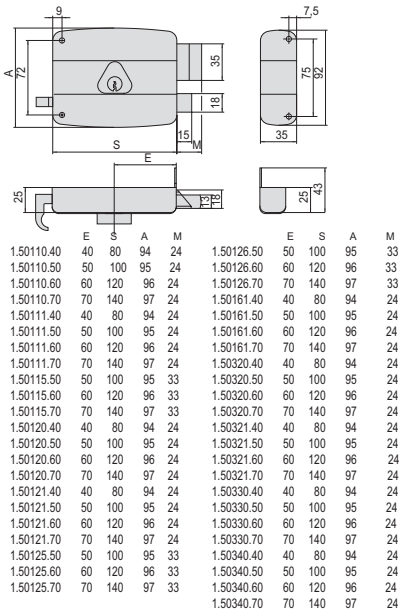

12

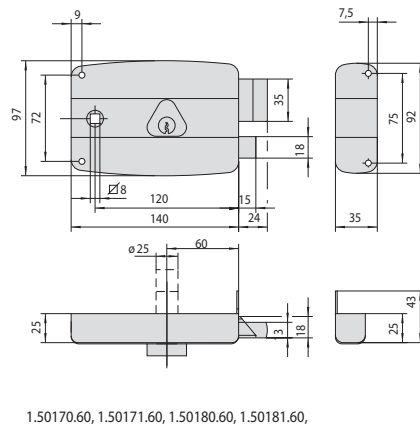

15

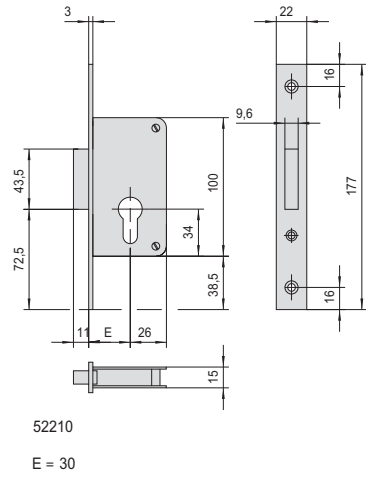

18

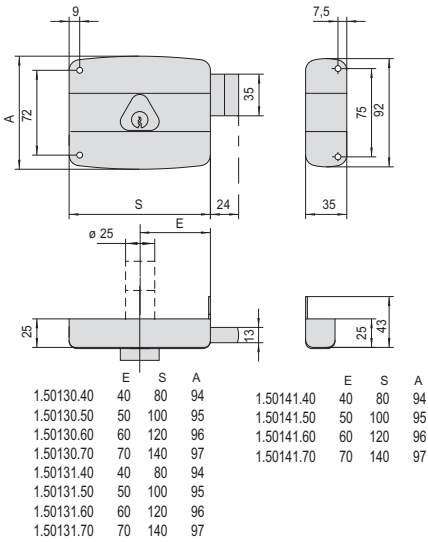

13

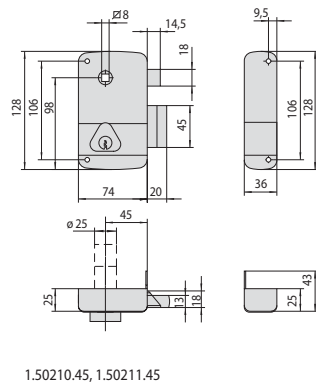

16

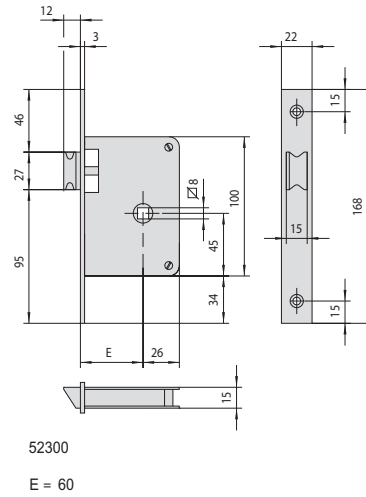

19

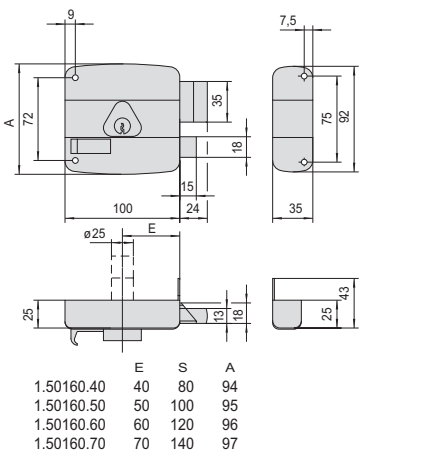

14

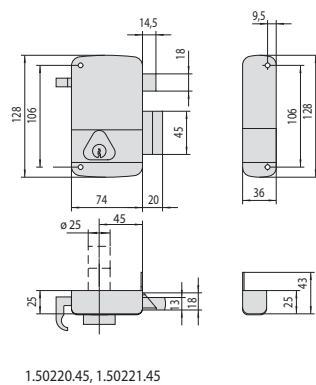

17

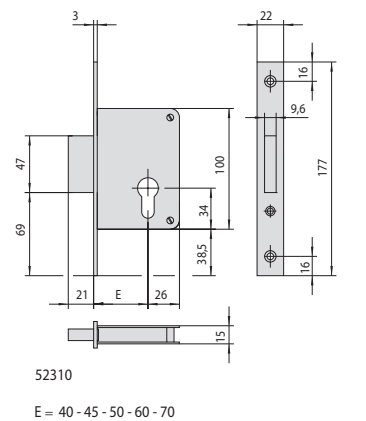

20

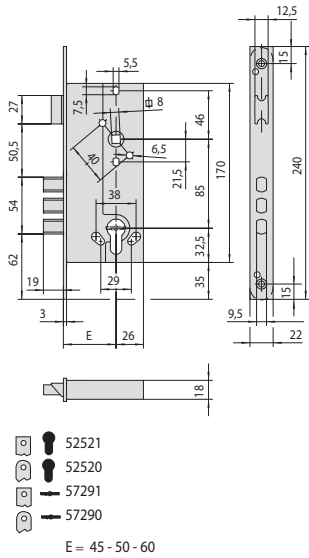

21

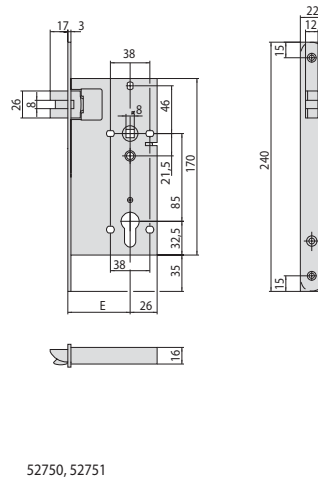

24

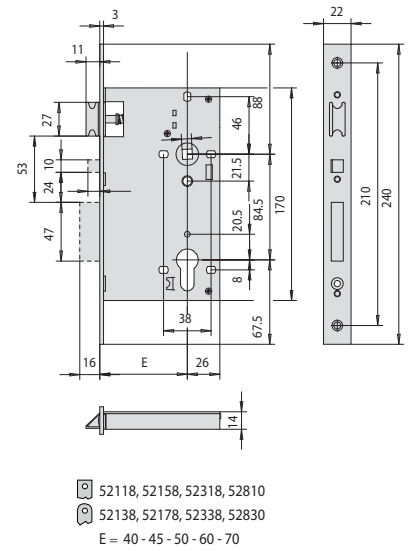

27

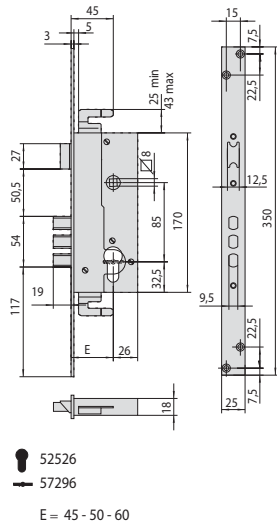

22

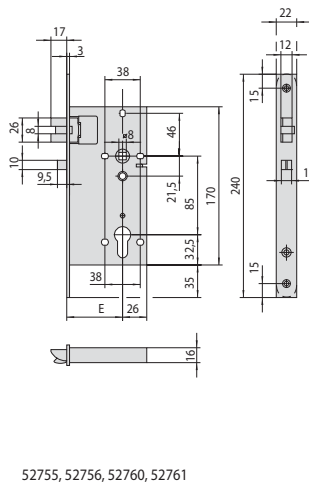

25

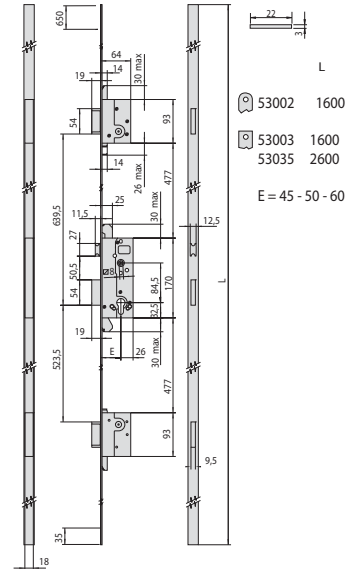

28

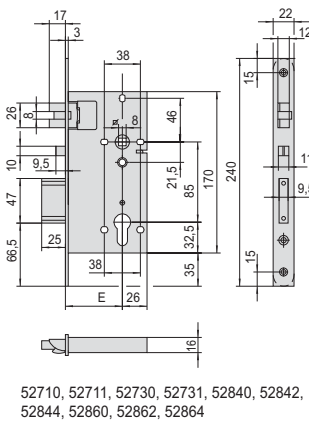

23

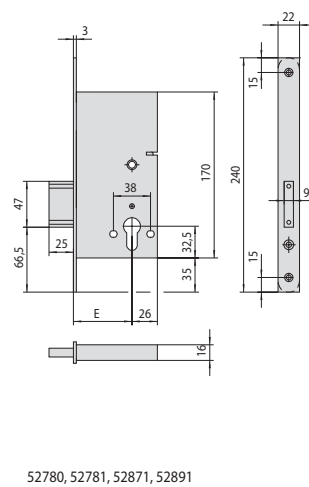

26

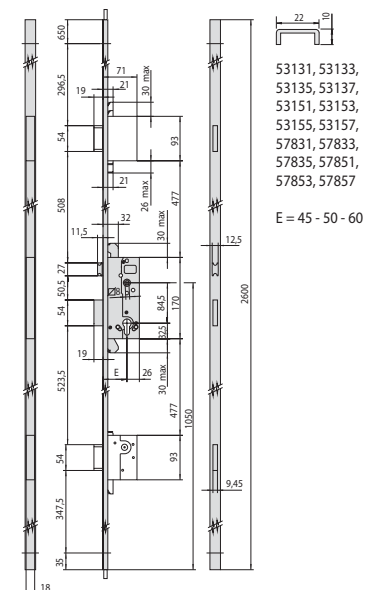

29

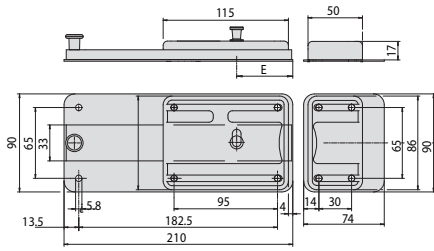

55051, 55054, 55071, 55074

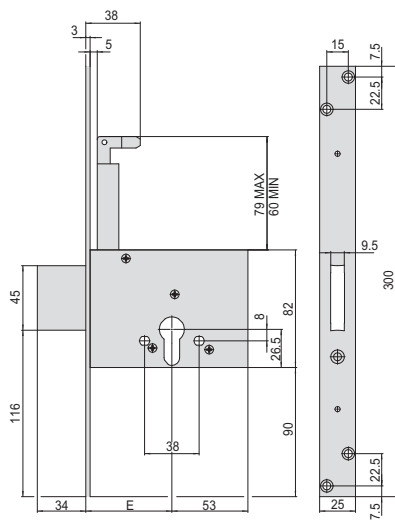

56020
E = 60 - 70

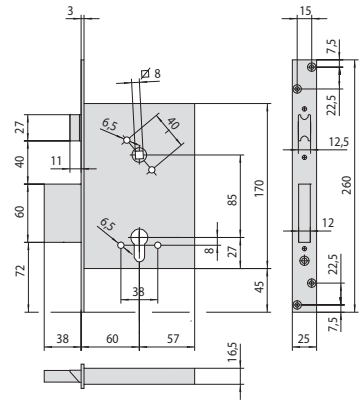

1.56250.60

30

35

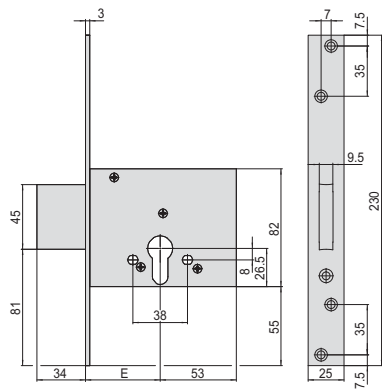

56010
E = 52 - 60 - 70

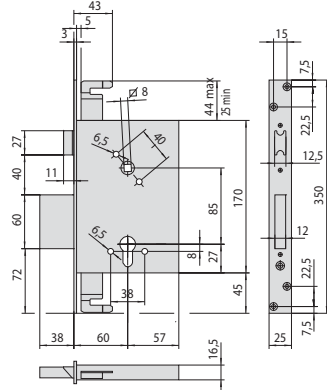
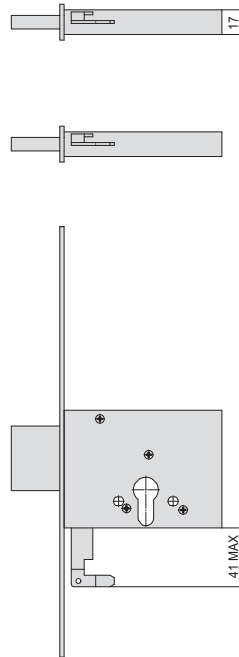

1.56255.60

31

36

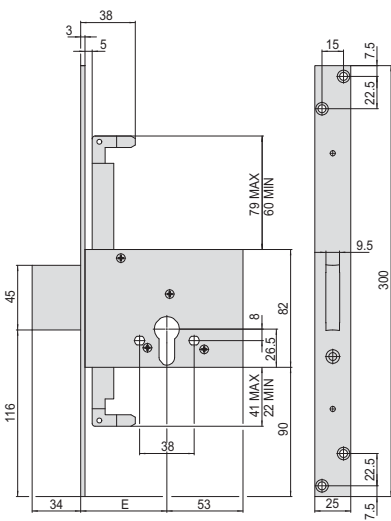

56015
E = 60 - 70

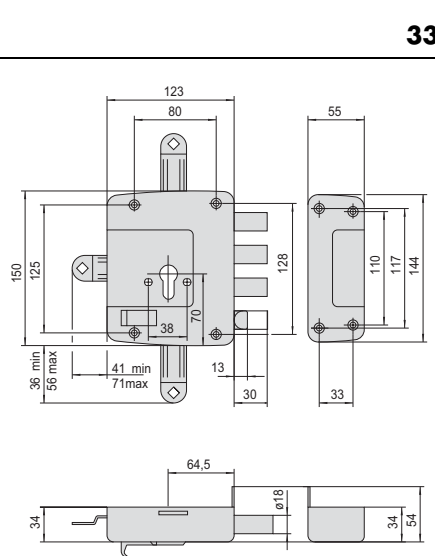

56152, 56162, 56172, 56157, 56167, 56177

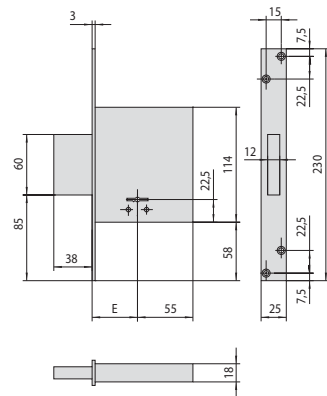

57010, 57014 57050
E = 52 - 60 - 70 E = 52 - 60

32

34

37

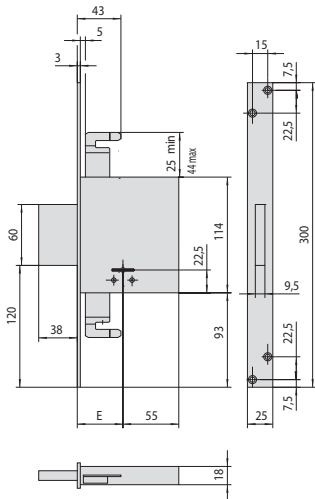

57015, 57019 1.57055.60
E = 60 - 70 E = 60

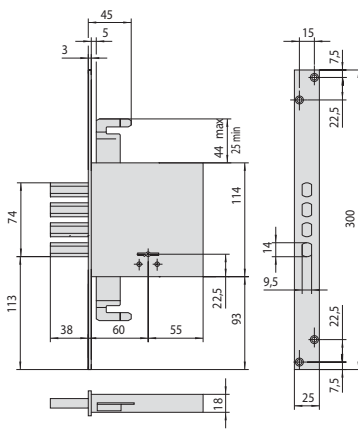

1.57033.60

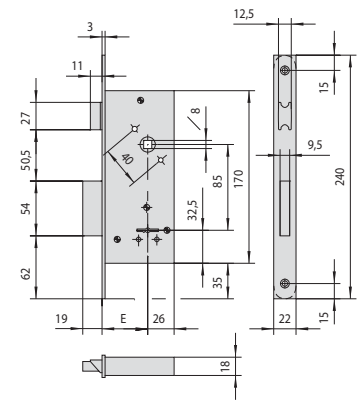

57210
57211
E = 40 - 45 - 50 - 60

38

41

44

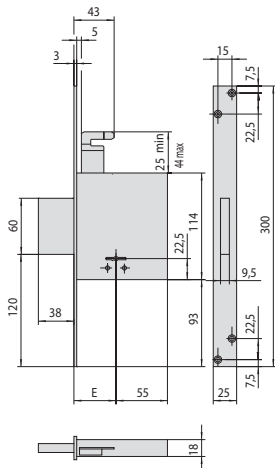

57020, 57024
E = 60 - 70

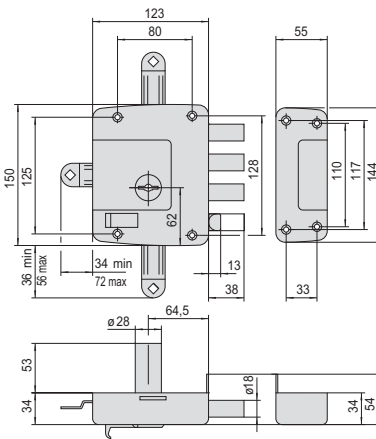

1.57152.60, 1.57157.60, 1.57162.60,
1.57167.60, 1.57172.60, 1.57177.60

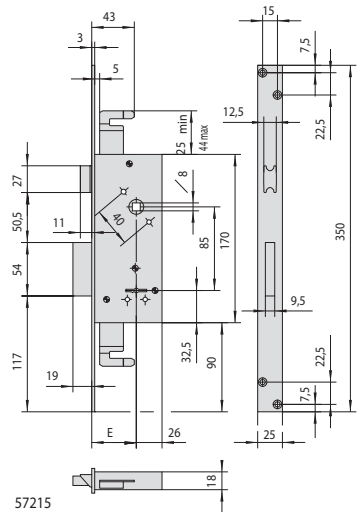

57215
E = 45 - 50 - 60

39

42

45

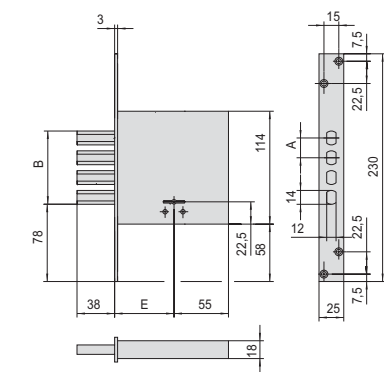

	E	A	B
1.57028.50	52	23	60
1.57028.60	60	20	74

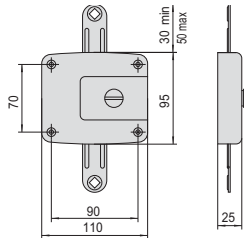

1.57192.00

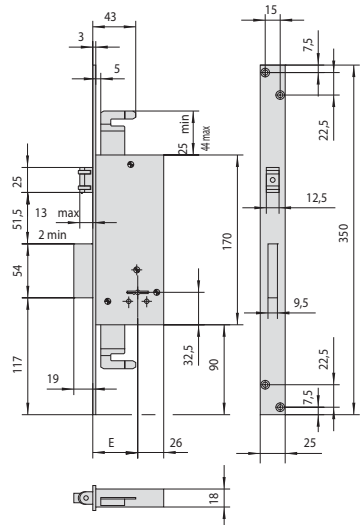

57217
E = 45 - 50 - 60

40

43

46

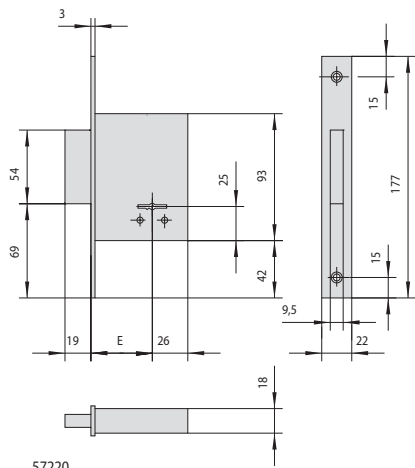

57220

E = 40 - 45 - 50 - 60

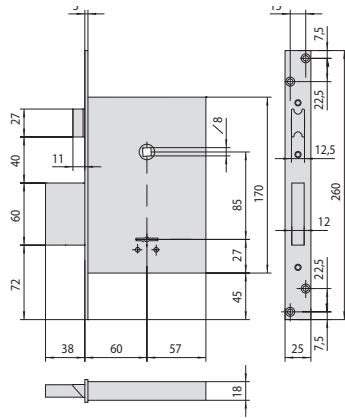

57250, 57254

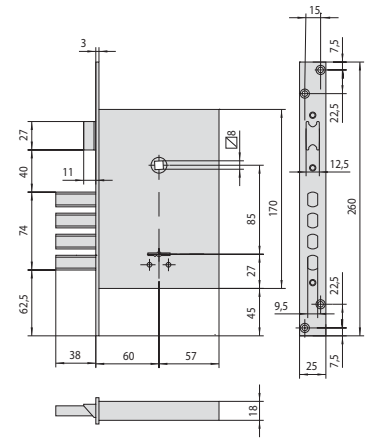

57260

47

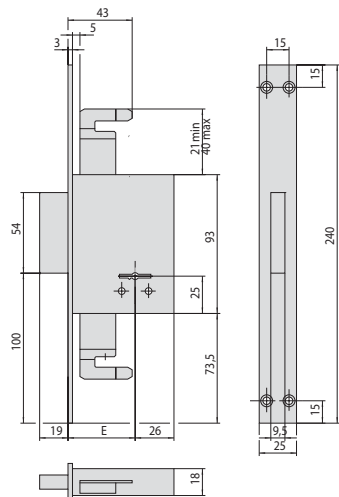

57225

E = 45 - 50 - 60

50

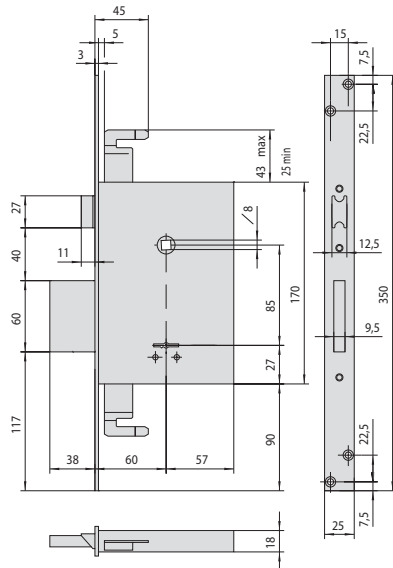

57255, 57259

53

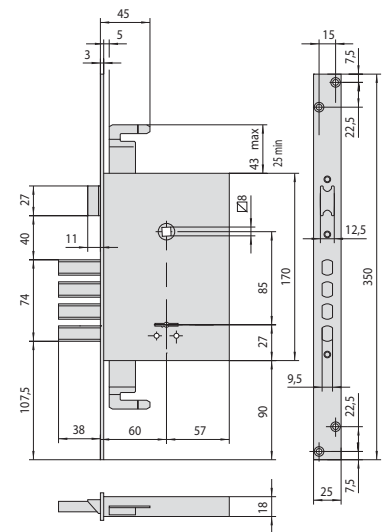

57265

48

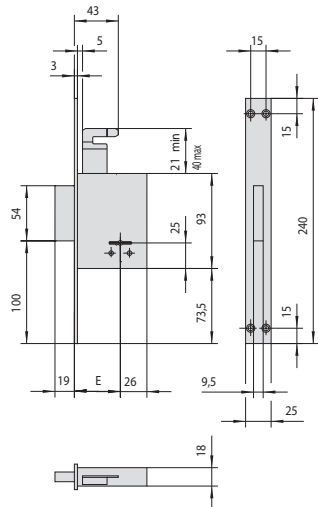

57230

E = 45 - 50 - 60

51

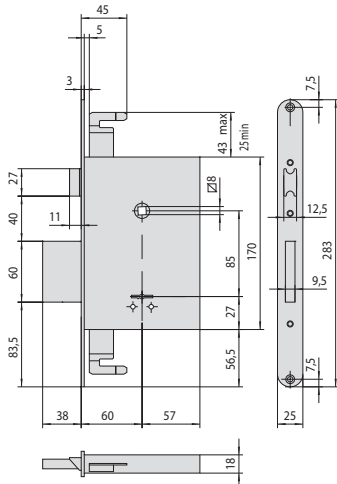

1.57256.60

54

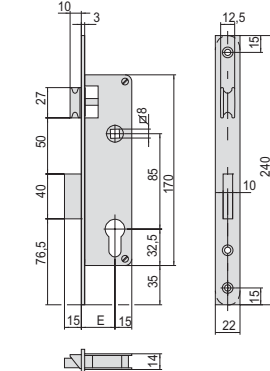

5C010, 5C011,
5C031
E = 21 - 25 - 30

49

52

55

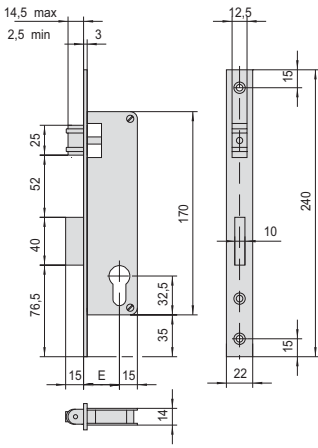

5C021
E = 21 - 25 - 30

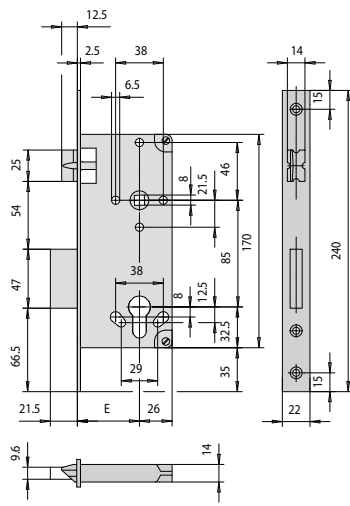

5C611, 5C651
5C631, 5C671
E = 35 - 40 - 45 - 50 - 60 - 70

56

59

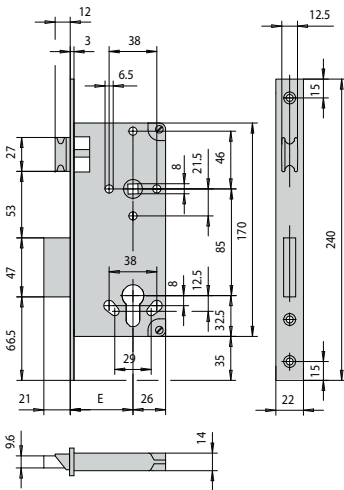

5C110, 5C150, 5C611, 5C651
5C130, 5C170, 5C631, 5C671
E = 35 - 40 - 45 - 50 - 60 - 70

57

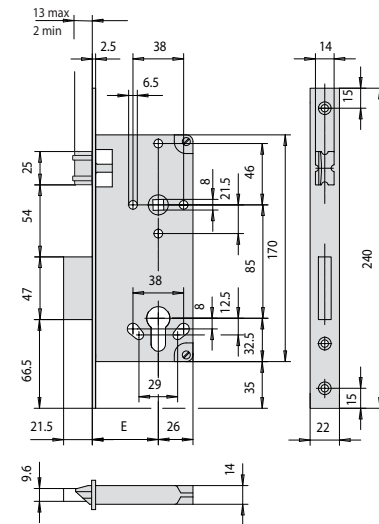

5C621
5C641
E = 35 - 40 - 45 - 50 - 60 - 70

60

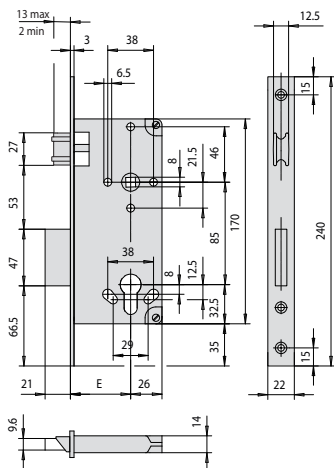

5C120, 5C621
5C140, 5C641
E = 35 - 40 - 45 - 50 - 60 - 70

58

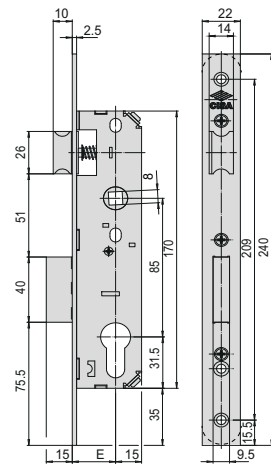

5C021
5C032
E = 20 - 25 - 30

61



Locks for armour plated doors



Domo Connexa motorized rim locks	393	Exitlock panic function mortice locks	411
Domo Connexa motorized mortice locks.....	394	Double-bit key rekeyable rim locks New Cambio Facile.	412
Cisa Button and components Domo Connexa locks ...	395	Double-bit key rekeyable mortice locks	414
MyEVO rim powered electronic locks	397	Spare keys for rekeyable double-bit key locks	416
MyEVO mortice powered electronic locks.....	398	Double-bit key rim locks	417
MyEVO locks configuration components	399	Double-bit key mortice locks	419
Comfortlock panic function rim locks	401	Multifunction rim locks	421
Comfortlock panic function mortice locks.....	402	Multifunction mortice locks	429
Cylinder rim locks Cisa Revolution PRO	403	Double-bit key cylinders	437
Cylinder mortice locks Cisa Revolution PRO	404	Protection roses	439
Cylinder rim locks with gear mechanism	405	Locks for blocking systems	446
Cylinder mortice locks with gear mechanism.....	407	Electric strikers for armour plated door locks	447
Exitlock system functions	409	Accessories for armour plated door locks.....	448
Exitlock panic function rim locks	410	Dimensional drawings	457

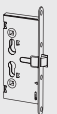
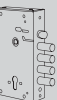



DOMO
connexa



**NO MORE
KEYS**



**NO MORE
WORRIES**

THE SMART SOLUTION FOR ARMoured DOORS

The Domo Connexa lock combines CISA security with smart management. Thanks to the Nuki app, you can lock and unlock the door and set up remote access.



CISA[®]
Smart Home Access Solutions

   cisa.com
allegion.com

ALLEGION 



Technical features:

- European cylinder motorized lock for SMART applications. To be combined with CISA BUTTON
- Motorized operation of the latchbolt, the deadbolts and extension bolts
- Automatic closing of the deadbolts by pulling the door closer
- Emergency opening with the mechanical key
- Zinc plated steel case and cover
- Zinc plated steel deadbolts.
- Zinc plated non-handed latchbolt.
- Anti-crush plates for fixing screws
- Steel extension bolts

Supplied as standard:

- Door status contacts strip

Finishes:

- Zinc-plated aluminium

Standards:

- Product compliant with the standard EN 12209:16 and EN 14846:08

Cylinder to be ordered separately



CISA DOMO

Type	Description	DEADBOLTS								ITEM			
		No.	Projection	Centre Distance	Throws	Centre Distance	Faceplate	Backset	Unit weight Kg	Pieces	Type	Dim. Hand	Fin.

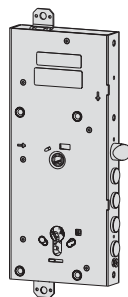

- Motorised lock
- Automatic closing of latchbolt and deadbolt.
- Powered by batteries or power supply.

4	3,5	28	85	64	3,800	1	1	E6517 28 0
3	3,5	38	85	64	3,800	1	1	E6517 38 0



Technical features:

- European cylinder motorized lock for SMART applications. To be combined with CISA BUTTON
- Motorized operation of the latchbolt, the deadbolts and extension bolts
- Automatic closing of the deadbolts by pulling the door closer
- Emergency opening with the mechanical key
- Zinc plated steel case and cover
- Zinc plated steel deadbolts.
- Zinc plated steel non-handed latchbolt.
- Anti-crush plates for fixing screws
- Steel extension bolts

Supplied as standard:

- Door status contacts strip

Finishes:

- Zinc-plated aluminium

Standards:

- Product compliant with the standard EN 14846:08
- Product compliant with the standard EN 12209:16

Cylinder to be ordered separately



CISA DOMO

Type	Description	DEADBOLTS							Unit weight	Pieces	ITEM			
		No.	Projection	Centre Distance	Throws	Centre Distance	Faceplate	Backset			Type	Dim.	Hand	Fin.

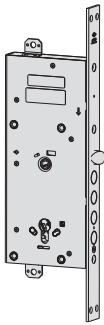

- Motorised lock
 - Automatic closing of latchbolt and deadbolts.
 - Powered by batteries or power supply.

4	28	85	35	67	3,800	1	1	E6537 28 0
---	----	----	----	----	-------	---	---	-------------------



Technical features:

- Nylon body
- Anodized aluminium rose
- SMART button to be combined with CISA DOMO CONNEXA motorized lock
- Connettivity:
 - Bluetooth Low Energy 5.0.
- Compatibility:
 - Android 5.0 and later
 - iOS 11.4 and later and watchOS 4.0 or later

Supplied as standard:

- Connexion cables

CISA BUTTON

Type	Description	Unit weight	Pieces	ITEM				
				Type	Dim.	Hand	Fin.	Pers. Spec.
<ul style="list-style-type: none"> • Square button • Silver gray anodized aluminum 		0,100	1	1	065C4	53	0	A3
	<ul style="list-style-type: none"> • Square button • Matt black anodized aluminum 	0,100	1	1	065C4	53	0	A5
<ul style="list-style-type: none"> • Round button • Silver gray anodized aluminum 		0,100	1	1	065C4	54	0	A3
	<ul style="list-style-type: none"> • Round button • Matt black anodized aluminum 	0,100	1	1	065C4	54	0	A5
<ul style="list-style-type: none"> • Pair of door status contacts 		0,035	1	1	06510	50	0	
<ul style="list-style-type: none"> • Power supply for motorised lock (24V, DC). 		0,492	1	1	07060	03	0	
<ul style="list-style-type: none"> • 12,5V DC power supply with buffer module for connection to the mains power supply 		0,492	1	1	07060	05	0	

Type	Description	Unit weight	Pieces	ITEM				
				Type	Dim.	Hand	Fin.	Pers. Spec.
	<ul style="list-style-type: none"> Battery holder group with cable (for 12 x 1.5V AA batteries, not included) 	0,600	1	1	07030	80	0	
	<ul style="list-style-type: none"> Battery holder group with cable (for 12 x 1.5V C type batteries, not included) 	0,600	1	1	07030	81	0	
	<ul style="list-style-type: none"> Power supply cable (when lock is powered by the mains) 	0,600	1	1	07030	70	0	
	<ul style="list-style-type: none"> Cable to open door using remote control (e.g. Intercom, button) 	0,150	1	1	07030	72	0	
	<ul style="list-style-type: none"> NUKI KEYPAD 	0,050	1	1	N1001	01	B	
	<ul style="list-style-type: none"> NUKI KEYPAD 2.0 	0,050	1	1	N1001	01	T	
	<ul style="list-style-type: none"> NUKIFOB 	0,030	1	1	N1001	01	A	
	<ul style="list-style-type: none"> NUKIBRIDGE+ RAAC (Remote Access Activation Code) 	0,300	1	1	N1001	01	R	



MyEVO

Technical features:

- Powered latch-bolt, deadbolt and extension bolts for automatic operation
- Automatic closing of the door
- Emergency opening with the mechanical key
- Zinc plated steel case and cover
- Zinc plated steel deadbolts.
- Zinc plated non-handed latchbolt.
- Anti-crush plates for fixing screws
- Steel extension bolts

Supplied as standard:

- Pair of door status contacts 1.06510.50.0

Finishes:

- Zinc-plated aluminium

Standards:

- Product compliant with the standard EN 14846:08
- Product compliant with the standard EN 12209:16

Hand:

0 = Non-handed

Cylinder to be ordered separately



Type	Description	DEADBOLTS							ITEM				
		No.	Projection	Centre Distance	Throws	Centre Distance	Faceplate	Backset	Unit weight	Pieces	Type	Dim.	Hand

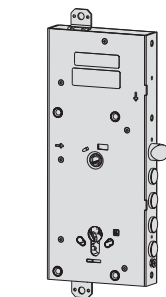

- CISA motorised lock
- Rim version
- Latchbolt and deadbolt
- SUPPLIED AS STANDARD:
- door status contacts strip with cable

4	3,5	28	85	64	4,800	1	1	E6516 28 0
3	3,5	38	85	64	4,800	1	1	E6516 38 0



MyEVO

Technical features:

- Powered latch-bolt, deadbolt and extension bolts for automatic operation
- Automatic closing of the door
- Emergency opening with the mechanical key
- Steel case and cover
- Zinc plated steel faceplate.
- Zinc plated steel deadbolts.
- Zinc plated non-handed latchbolt.
- Anti-crush plates for fixing screws
- Steel extension bolts

Supplied as standard:

- Pair of door status contacts 1.06510.50.0

Finishes:

- Zinc-plated aluminium

Standards:

- Product compliant with the standard EN 14846:08
- Product compliant with the standard EN 12209:16

Hand:

0 = Non-handed





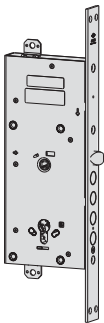

Cylinder to be ordered separately



Type	Description	DEADBOLTS									ITEM				
		No.	Projection	Centre Distance	Throws	Centre Distance	Faceplate	Backset	Kg	Pieces	Type	Dim.	Hand	Fin.	Pers.
		4	28	85	35	67	3,800	1	1	E6536	28	0			



- CISA motorised lock
- Mortice version
- Latchbolt and deadbolt
- SUPPLIED AS STANDARD:
- door status contacts strip with cable

Type	Description			ITEM				
		Unit weight	Pieces	Type	Dim.	Hand	Fin.	Pers. Spec.
	<ul style="list-style-type: none"> • Door status contacts strip 	0,035	1	1	06510	50	0	
	<ul style="list-style-type: none"> • INTERNAL BUTTON - Graphite black finish - Dove grey finish - Aluminium finish - White pearl finish 	0,385	1	1	06525	51	0 L6	
		0,385	1	1	06525	51	0 L7	
		0,385	1	1	06525	51	0 L8	
		0,385	1	1	06525	51	0 L9	
	<ul style="list-style-type: none"> • EXTERNAL KEYPAD - Graphite black finish - Dove grey finish - Aluminium finish - White pearl finish 	0,385	1	1	06525	71	0 L6	
		0,385	1	1	06525	71	0 L7	
		0,385	1	1	06525	71	0 L8	
		0,385	1	1	06525	71	0 L9	
	<ul style="list-style-type: none"> • EXTERNAL KEYPAD AND TRANSPONDER - Graphite black finish - Dove grey finish - Aluminium finish - White pearl finish • STANDARD: - 5 black user mini card - 1 white master card for programming - 1 red reset card 	0,385	1	1	06525	73	0 L6	
		0,385	1	1	06525	73	0 L7	
		0,385	1	1	06525	73	0 L8	
		0,385	1	1	06525	73	0 L9	
	<ul style="list-style-type: none"> • EXTERNAL TRANSPONDER - Graphite black finish - Dove grey finish - Aluminium finish - White pearl finish • STANDARD: - 5 black user mini card - 1 white master card for programming - 1 red reset card 	0,385	1	1	06525	75	0 L6	
		0,385	1	1	06525	75	0 L7	
		0,385	1	1	06525	75	0 L8	
		0,385	1	1	06525	75	0 L9	
	<ul style="list-style-type: none"> • USER CARD • Kit of 5 cards 	0,085	1	1	06526	11	0	
	<ul style="list-style-type: none"> • USER MINI CARD • Kit of 5 cards 	0,085	1	1	06526	21	0	

Type	Description	Kg		Pieces		ITEM				
		Unit weight	Pieces	Type	Dim.	Hand	Fin.	Pers.	Spec.	
	<ul style="list-style-type: none"> CHANGE AND SAFE MODE CARD KIT 	0,085	1	1	06526	30	0			
	<ul style="list-style-type: none"> MASTER AND RESET CARD KIT 	0,085	1	1	06526	40	0			
	<ul style="list-style-type: none"> Power supply for motorised lock (24V, DC). Powered by electrical system or by rechargeable batteries 	0,492	1	1	07060	03	0			
	<ul style="list-style-type: none"> 12,5V DC power supply with buffer module for connection to the mains power supply 	0,492	1	1	07060	05	0			
	<ul style="list-style-type: none"> Power supply cable (when lock is powered by the mains) 	0,600	1	1	07030	70	0			
	<ul style="list-style-type: none"> Cable to open door using remote control (e.g. Intercom, button) 	0,600	1	1	07030	72	0			
	<ul style="list-style-type: none"> Battery holder group with cable (for 12 x 1.5V AA batteries, not included) 	0,600	1	1	07030	80	0			
	<ul style="list-style-type: none"> Battery holder group with cable For 12 x 1.5V C batteries, not included 	0,600	1	1	07030	81	0			



Technical features:

- Steel case and cover.
- Zinc-plated high resistant steel deadbolts.
- Zinc-plated high resistant steel non-handed latch.
- Anti-crush plates for screw fixing.
- Steel active pins.
- 1 pc or 5 pcs packages (industrial packaging)

On request:

- Cylinder protective roses series 06460; 06480; 06485.
- Inside escutcheons series 06473.

Finishes:

- Zinc aluminum.

Hand:

0 = Non-handed

Cylinder to be ordered separately



ComFortlock

Type	Description	DEADBOLTS								ITEM			
		No.	Projection	Centre distance	Throws	Centre Distance	Faceplate	Backset	Unit weight	Pieces	Type	Dim.	Hand

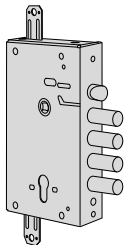

- Deadbolt and latch
- Pre-setting for additional locking points
- Operation:
- Closing from inside
deadbolts operated by rotating handle upwards and/or with key.

4	3,5	28	2	85	64	2,650	1	1 56815 28 0
3	3,5	38	2	85	64	2,650	1	1 56815 38 0
4	3,5	28	2	85	64	2,550	5	1 56815 48 0
3	3,5	38	2	85	64	2,550	5	1 56815 58 0

Opening from inside:
latchbolt with handle and/or key
deadbolts by rotating handle downwards
(function to be selected according to user's choice)
and/or key

Closing from outside
deadbolts operated by rotating handle upwards
and/or with key

Opening from outside:
latchbolt with handle and/or key
deadbolts with key



Technical features:

- Steel case and cover.
- Zinc-plated high resistant steel faceplate
- Zinc-plated high resistant steel deadbolts.
- Zinc-plated high resistant steel non-handed latch.
- Anti-crush plates for screw fixing.
- Steel active pins.
- 1 pc or 5 pcs packages (industrial packaging)

On request:

- Cylinder protective roses series 06460; 06480; 06485.
- Inside escutcheons series 06473.

Finishes:

- Zinc aluminum.

Hand:

0 = Non-handed

Cylinder to be ordered separately



ComFortlock

Type	Description	DEADBOLTS								ITEM				
		No.	Projection	Centre Distance	Throws	Centre Distance	Faceplate	Backset	Unit weight Kg	Pieces	Type	Dim.	Hand	Fin.

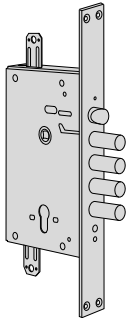

- Deadbolt and latch
- Pre-setting for additional locking points
- Operation:
 - Closing from inside
deadbolts operated by rotating handle upwards and/or with key.
 - Opening from inside:
latchbolt with handle and/or key
deadbolts by rotating handle downwards (function to be selected according to user's choice) and/or key
 - Closing from outside
deadbolts operated by rotating handle upwards and/or with key
 - Opening from outside:
latchbolt with handle and/or key
deadbolts with key

4	28	2	85	35	67	2,800	1	1	56835 28 0
4	28	2	85	35	67	2,700	5	1	56835 48 0



Technical features:

- LOCK FITTED WITH A BLOCKING DEVICE WHICH IS ACTIVATED IF THE CYLINDER IS EXTRACTED
- Effort reducer gear-operated system
- Zinc-plated steel case
- High-resistance zinc-plated reversible latch
- High resistance zinc-plated deadbolts
- Package: 1 pc or 5 pcs (industrial package)
- Two different dimensions are available as standard to meet various installation requirements.
- 12V ac voltage
- Absorbed current: 3.1 A

Hand:

0 = Non-handed

Cylinder to be ordered separately



CISA Revolution PRO

Type	Description	DEADBOLTS								ITEM			
		No.	Projection	Centre Distance	Throws	Centre Distance	Faceplate	Backset	Unit weight	Pieces	Type	Dim.	Hand

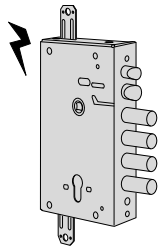

- Deadbolt and latch
- Electrically controlled dead-locking latch
- Slide item 1.06224.50.0
- Pre-set for additional locking points

4	3,5	28	2	85	64	2,660	1	1	15515 28 B
3	3,5	38	2	85	64	2,520	1	1	15515 38 B
4	3,5	28	2	85	64	2,430	1	1	15515 48 B
3	3,5	38	2	85	64	2,220	1	1	15515 58 B

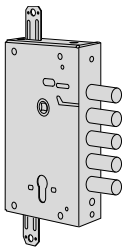

- Deadbolt only
- Pre-set for additional locking points

5	3,5	28	2	85	64	2,370	1	1	56505 28 B
4	3,5	38	2	85	64	2,370	1	1	56505 38 B
5	3,5	28	2	85	64	2,370	5	1	56505 48 B

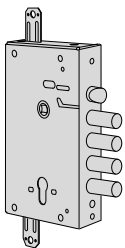

- Deadbolt and latch
- Pre-set for additional locking points

4	3,5	25	2	85	64	2,650	1	1	56515 28 B
3	3,5	38	2	85	64	2,320	1	1	56515 38 B
4	3,5	28	2	85	64	2,346	5	1	56515 48 B
3	3,5	38	2	85	64	2,300	5	1	56515 58 B

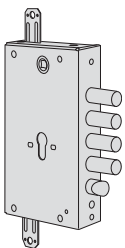

- Deadbolt and latch
- Pre-set for additional locking points

4	3,5	28	2	85	64	2,550	1	1	B6515 28 B
3	3,5	38	2	85	64	2,550	1	1	B6515 38 B
4	3,5	28	2	85	64	2,620	5	1	B6515 48 B
3	3,5	38	2	85	64	2,620	5	1	B6515 58 B



Technical features:

- LOCK FITTED WITH A BLOCKING DEVICE WHICH IS ACTIVATED IF THE CYLINDER IS EXTRACTED
- Effort reducer gear-operated system
- Zinc-plated steel case
- High-resistance zinc-plated reversible latch
- High resistance zinc-plated deadbolts
- High resistance zinc-plated steel faceplate
- Package: 1 pc or 5 pcs (industrial packing)
- Two different dimensions are available as standard to meet various installation requirements.
- 12V ac voltage
- Absorbed current: 3.1 A

Hand:
0 = Non-handed

Cylinder to be ordered separately



CISA Revolution PRO

Type	Description	DEADBOLTS								ITEM				
		No.	Projection	Centre Distance	Throws	Centre Distance	Faceplate	Backset	Unit weight	Pieces	Type	Dim.	Hand	Fin.

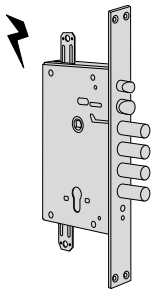

- Deadbolt and latch
- Electrically controlled dead-locking latch
- Slide item 1.06224.50.0
- Pre-set for additional locking points

4	28	2	85	35	67	2,790	1	1	15535 28 B
4	28	2	85	35	67	2,490	5	1	15535 48 B

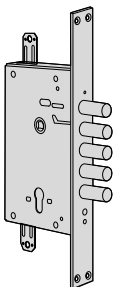

- Deadbolt only
- Pre-set for additional locking points

5	28	2	85	35	67	2,650	1	1	56525 28 B
5	28	2	85	35	67	2,600	5	1	56525 48 B

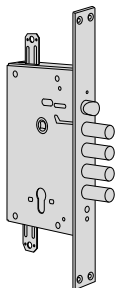

- Deadbolt and latch
- Pre-set for additional locking points

4	28	2	85	35	67	2,800	1	1	56535 28 B
4	28	2	85	35	67	2,600	5	1	56535 48 B

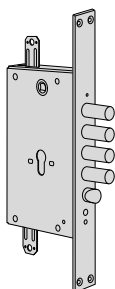

- Deadbolt and latch
- Pre-set for additional locking points

4	28	2	85	35	67	3,100	1	1	B6535 28 B
4	38	2	85	35	67	2,600	1	1	B6535 38 B
4	28	2	85	35	67	2,300	5	1	B6535 48 B
4	38	2	85	35	67	2,300	5	1	B6535 58 B



Technical features:

- Geared operating device for reduced key effort
- Zinc-plated steel case
- Zinc-plated high resistant reversible latch
- Zinc-plated high resistant steel bolts
- Packing: 1 or 5 pcs. (industrial wrapping)
- Range developed according to 2 dimensional standards to meet any installation requirements
- Current absorption 3,1 A
- Voltage 12 V ac

Hand:

0 = Non-handed

Cylinder to be ordered separately



Revolution

Type	Description	DEADBOLTS								ITEM			
		No.	Projection	Centre Distance	Throws	Centre Distance	Faceplate	Backset	Unit weight	Pieces	Type	Dim.	Hand

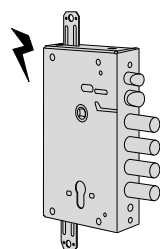

- Deadbolt and latch
- Electrically controlled dead-locking latch
- Slide item 1.06224.50.0
- Pre-set for additional locking points

4	3,5	28	2	85	64	2,660	1	1	15515	28	0			
3	3,5	38	2	85	64	2,520	1	1	15515	38	0			
4	3,5	28	2	85	64	2,430	5	1	15515	48	0			
3	3,5	38	2	85	64	2,220	5	1	15515	58	0			

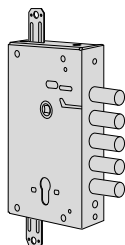

- Deadbolt only
- Pre-set for additional locking points

5	3,5	28	2	85	64	2,370	1	1	56505	28	0			
4	3,5	38	2	85	64	2,370	1	1	56505	38	0			
5	3,5	28	2	85	64	2,235	5	1	56505	48	0			
4	3,5	38	2	85	64	2,240	5	1	56505	58	0			

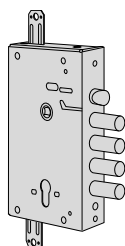

- Deadbolt and latch
- Pre-set for additional locking points

4	3,5	25	2	85	64	2,320	1	1	56515	25	0			
4	3,5	27	2	85	64	2,320	1	1	56515	27	0			
4	3,5	28	2	85	64	2,650	1	1	56515	28	0			
3	3,5	32	2	85	64	2,320	1	1	56515	32	0			
3	3,5	38	2	85	64	2,320	1	1	56515	38	0			
4	3,5	28	2	85	64	2,346	5	1	56515	48	0			
3	3,5	38	2	85	64	2,300	5	1	56515	58	0			
4	3,5	28	2	92	64	2,320	1	1	56615	28	0			
4	3,5	28	2	92	64	2,370	5	1	56615	48	0			
3	3,5	38	2	92	64	2,360	5	1	56615	58	0			

Type	Description	DEADBOLTS								ITEM				
		No.	Projection	Centre Distance	Throws	Centre Distance	Faceplate	Backset	Unit weight Kg	Pieces	Type	Dim.	Hand	Fin.

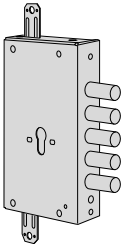

- Deadbolt only
- Pre-set for additional locking points

5	3,5	28	2	85	64	2,370	1	1	B6505 28 0
4	3,5	38	2	85	64	2,370	1	1	B6505 38 0
5	3,5	28	2	85	64	2,070	5	1	B6505 48 0
4	3,5	38	2	85	64	2,070	5	1	B6505 58 0

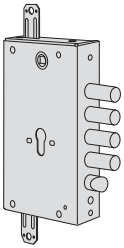

- Deadbolt and latchbolt
- Pre-set for additional locking points

4	3,5	25	2	85	64	2,550	1	1	B6515 25 0
4	3,5	28	2	85	64	2,550	1	1	B6515 28 0
3	3,5	38	2	85	64	2,550	1	1	B6515 38 0
4	3,5	28	2	85	64	2,620	5	1	B6515 48 0
3	3,5	38	2	85	64	2,600	5	1	B6515 58 0

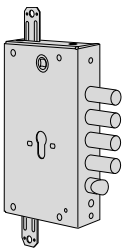

- Deadbolt and latchbolt
- Pre-set for additional locking points

4	3,5	28	2	92	64	2,550	1	1	B6615 28 0
3	3,5	38	2	92	64	2,550	1	1	B6615 38 0
4	3,5	28	2	92	64	2,020	5	1	B6615 48 0
3	3,5	38	2	92	64	2,020	5	1	B6615 58 0



Technical features:

- Geared operating device for reducing key effort
- Zinc-plated steel case
- Zinc-plated high resistant satin steel faceplate
- Zinc-plated high resistant reversible latch
- Zinc-plated high resistant steel deadbolts
- Packing: 1 or 5 pcs. (industrial wrapping)
- Range developed according to 2 dimensional standards to meet any installation requirements
- Current absorption 3,1 A
- Voltage 12 V ac

Hand:

0 = Non-handed

Cylinder to be ordered separately



Revolution

Type	Description	DEADBOLTS								ITEM			
		No.	Projection	Centre Distance	Throws	Centre Distance	Faceplate	Backset	Unit weight Kg	Pieces	Type	Dim.	Hand

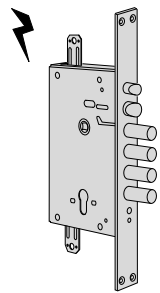

- Deadbolt and latch
- Electrically controlled dead-locking latch
- Slide item 1.06224.50.0
- Pre-set for additional locking points

4	28	2	85	35	67	2,790	1	1	15535	28	0			
4	28	2	85	35	67	2,490	5	1	15535	48	0			

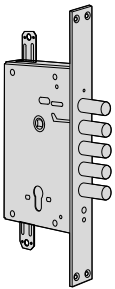

- Deadbolt only
- Pre-set for additional locking points

5	28	2	85	35	67	2,650	1	1	56525	28	0			
5	28	2	85	35	67	2,600	5	1	56525	48	0			

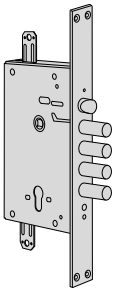

- Deadbolt and latch
- Pre-set for additional locking points

4	28	2	85	35	67	2,800	1	1	56535	28	0			
4	28	2	85	35	67	2,600	5	1	56535	48	0			

Type	Description	DEADBOLTS								ITEM				
		No.	Projection	Centre Distance	Throws	Centre Distance	Faceplate	Backset	Unit weight Kg	Pieces	Type	Dim.	Hand	Fin.

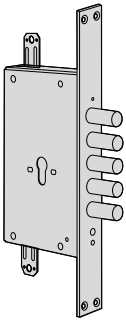

- Deadbolt only
- Pre-set for additional locking points

5	28	2	85	35	67	2,650	1	1	B6525 28 0
5	38	2	85	35	67	2,650	1	1	B6525 38 0
5	28	2	85	35	67	2,350	5	1	B6525 48 0
5	38	2	85	35	67	2,350	5	1	B6525 58 0

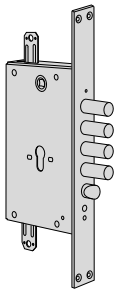

- Deadbolt and latch
- Pre-set for additional locking points

4	28	2	85	35	67	3,100	1	1	B6535 28 0
4	38	2	85	35	67	2,600	1	1	B6535 38 0
4	28	2	85	35	67	2,300	5	1	B6535 48 0
4	38	2	85	35	67	2,300	5	1	B6535 58 0

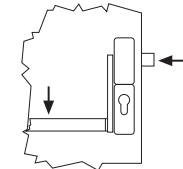
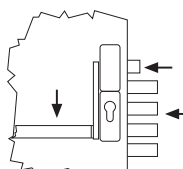
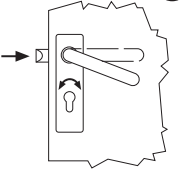
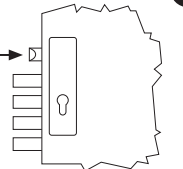
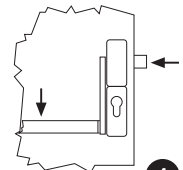
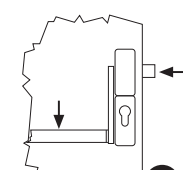
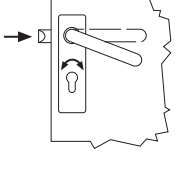
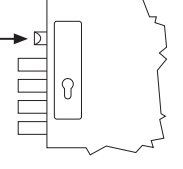
TYPE	CONTROLS	OPERATION
<p>B</p> <p>OUTSIDE HANDLE ENABLED/DISABLED</p> <p>For doors opening to the outside and for buildings in which free access must be programmed.</p>	<p>INSIDE</p> <ul style="list-style-type: none"> • Panic exit device to open • Key to close with deadbot or enable/disable the outside handle <p>OUTSIDE</p> <ul style="list-style-type: none"> • The key operates the deadbolt or enables/disables the outside handle to control the latchbolt 	 <p>1</p> <p>The outside handle can be enabled by turning the key all the way in the opening direction (the handle will continue to be enabled when the key is taken out).</p>  <p>2</p> <p>By closing the door with the deadbolt, the outside handle will be disabled and remain so even after opening the door via the panic exit device.</p>  
<p>D</p> <p>OUTSIDE HANDLE ALWAYS ENABLED</p> <p>For doors located in passage areas (e.g. corridors).</p>	<p>INSIDE</p> <ul style="list-style-type: none"> • Panic exit device to open • Key to close with deadbot <p>OUTSIDE</p> <ul style="list-style-type: none"> • Key to operate the deadbolt. The handle is enabled by the latch with the deadbolt pulled back 	 <p>1</p> <p>The outside handle is always enabled when the deadbolt is pulled back.</p>  <p>2</p> <p>After operating the panic exit device, access from the outside is always possible until the deadbolt is operated via the key.</p>  



Technical features:

- Steel case and cover.
- Zinc plated high resistant steel deadbolts.
- Zinc plated high resistant steel non-handed latch.
- Anti-crush plates for screw fixing.
- Steel active pins.
- 1 pc or 5 pcs packages (industrial packaging)

Supplied as standard:

- Striker plate series 06220.

On request:

- Cylinder protective roses series 06460; 06480; 06485.
- Inside escutcheons series 06473.
- Electric strikers series 15300
- For panic exits (UNI EN 1125) Panic exit device series 59607 + horizontal bar series 07007 or item 59711.10/11

For fire door (spec. FR)

- For additional locking points
Divertor item series 06433.00/01/11
Pair of bolts item 06425.06.0
Striker plates item 06220.28/29.0
- For panic exit doors (UNI EN 1125) panic exit device series 59607 plus horizontal bar series 07007 or item 59711-10/11
- For emergency exits (UNI EN 179)
Handle item 1.07070.50.0
Pair of handles item 1.07070.60.0

Finishes:

- Zinc aluminum.

Standards:

- UNI EN 179
- UNI EN 1125
- UNI EN 12209

Hand:

0 = Non-handed

Cylinder to be ordered separately



Exitlock

Type	Description	DEADBOLTS								ITEM		
		No.	Projection	Centre Distance	Throws	Centre Distance	Faceplate	Backset	Unit weight Kg	Pieces	Type	Dim. Hand

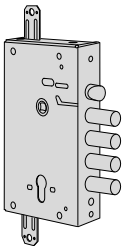

- Deadbolt and latch
- Pre-set for additional locking points

• FUNCTION TYPE B

- Inside:
Panic exit device and/or handle to open
Key to close with deadbolt and enable or disable the outside handle when latch is operated
- Outside:
Key to close with deadbolt and enable or disable the outside handle when latch is operated

4	3,5	27	2	85	64	2,650	1	1	56916 27 0
4	3,5	28	2	85	64	2,650	1	1	56916 28 0
3	3,5	38	2	85	64	2,650	1	1	56916 38 0
4	3,5	28	2	85	64	2,550	5	1	56916 48 0
3	3,5	38	2	85	64	2,550	5	1	56916 58 0

• FUNCTION TYPE D

- Inside:
The panic exit device and/or the handle to open
The key to close with the deadbolt
- Outside:
The key to close with the deadbolt. When the deadbolt is withdrawn, the handle is activated and can operate the latch

4	3,5	28	2	85	64	2,650	1	1	56917 28 0
3	3,5	38	2	85	64	2,650	1	1	56917 38 0
4	3,5	28	2	85	64	2,550	5	1	56917 48 0
3	3,5	38	2	85	64	2,550	5	1	56917 58 0



Technical features:

- Steel case and cover.
- Zinc-plated high resistant steel faceplate
- Zinc-plated high resistant steel deadbolts.
- Zinc-plated high resistant steel non-handed latch.
- Anti-crush plates for screw fixing.
- Steel active pins.
- 1 pc or 5 pcs packages (industrial packaging)

Supplied as standard:

- Striker plate series 06220.

On request:

- Cylinder protective roses series 06460; 06480; 06485.
- Inside escutcheons series 06473.
- Electric strikerst series 15300

- For additional locking points
Divertor item series 06433.00/01/11
Pair of bolts item 06425.06.0
Striker plates item 06220.28/29.0
- For panic exit doors (UNI EN 1125) panic exit device series 59607 plus horizontal bar series 07007 or item 59711-10/11
- For fire door (spec. FR)
- For emergency exits (UNI EN 179)
Handle item 1.07070.50.0
Pair of handles item 1.07070.60.0

Finishes:

- Zinc aluminum.

Standards:

- UNI EN 179
- UNI EN 1125
- UNI EN 12209

Hand:
0 = Non-handed

Cylinder to be ordered separately



Exitlock

Type	Description	DEADBOLTS								ITEM			
		No.	Projection	Centre Distance	Throws	Centre Distance	Faceplate	Backset	Unit weight	Pieces	Type	Dim. Hand	Fin.

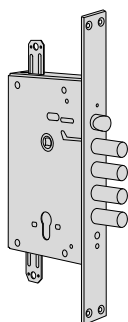

- Deadbolt and latch
- Pre-setting for additional locking points

• FUNCTION TYPE B

- Inside:
Panic exit device and/or handle to open
Key to close with deadbolt and enable or disable the outside handle when latch is operated
- Outside:
Key to close with deadbolt and enable or disable the outside handle when latch is operated

4	28	2	85	35	67	2,800	1	1	56936	28	0
4	28	2	85	35	67	2,650	5	1	56936	48	0

• FUNCTION TYPE D

- Inside:
The panic exit device and/or the handle to open
The key to close with the deadbolt
- Outside:
The key to close with the deadbolt. When the deadbolt is withdrawn, the handle is activated and can operate the latch

4	28	2	85	35	67	2,800	1	1	56937	28	0
4	28	2	85	35	67	2,650	5	1	56937	48	0



Technical features:

- The NEW CAMBIO FACILE system allows to re-key the lock by using a special re-keying tool and the keys, so that it is not necessary to disassemble the lock or any of its parts
- Zinc-plated steel case
- Zinc-plated high resistant reversible latch
- Zinc-plated high resistant, steel deadbolts
- Pre-set for additional locking points
- Packing: 1 or 5 pcs. (industrial wrapping)
- Range developed according to 2 dimensional standards to meet any installation requirements
- Current absorption 3,1 A
- Voltage 12 V ac

Operation:

- VERSION WITH CONSTRUCTION KEY: the key operates the 4 throws

Hand:
A = Non-handed

Supplied as standard:

- Keys
- Re-keying tool
- Key guide item 1.06142.01.0
- Inside escutcheon item 1.06143.00.0
- Outside escutcheon item 1.06082.00.0

Standards:

- **New manipulation and picking protection system: active on all six levers to block the lock in the event of burglary attempts**
- European Patent EP 2212493 B1

New CambioFacile

Type	Description	Key item	DEADBOLTS								ITEM				
			No.	Projection	Distance	Throws	Centre Distance	Facplate	Backset	Unit weight	Pieces	Type	Dim.	Hand	Fin.

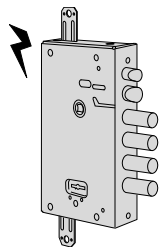

- CONSTRUCTION KEY VERSION
- Deadbolt and latch
- Electrically controlled dead-locking latch
- Slide item 1.06224.50.0

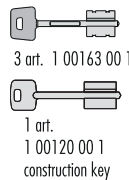

4	3,5	28	4	85	64	2,750	1	1	17665 28 A
4	3,5	38	3	85	64	2,750	1	1	17665 38 A
4	3,5	28	4	85	64	2,450	5	1	17665 48 A
3	3,5	38	4	85	64	2,450	5	1	17665 58 A

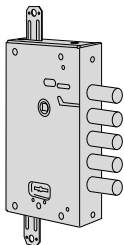

- CONSTRUCTION KEY VERSION
- Deadbolt only

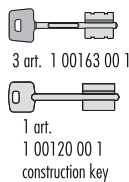

5	3,5	25	4	85	64	2,550	1	1	57655 25 A
5	3,5	27	4	85	64	2,550	1	1	57655 27 A
5	3,5	28	4	85	64	2,550	1	1	57655 28 A
4	3,5	32	4	85	64	2,550	1	1	57655 32 A
4	3,5	38	4	85	64	2,550	1	1	57655 38 A
5	3,5	27	4	85	64	2,250	5	1	57655 47 A
5	3,5	28	4	85	64	2,250	5	1	57655 48 A
4	3,5	38	4	85	64	2,250	5	1	57655 58 A

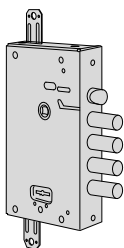

- CONSTRUCTION KEY VERSION
- Deadbolt and latch

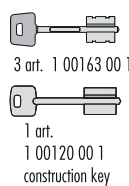

4	3,5	28	4	85	64	2,700	1	1	57665 28 A
3	3,5	38	4	85	64	2,700	1	1	57665 38 A
4	3,5	28	4	85	64	2,400	5	1	57665 48 A
3	3,5	38	4	85	64	2,400	5	1	57665 58 A

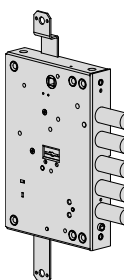

- VERSION WITH CONSTRUCTION KEY
- Deadbolt only

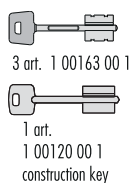

5	3,5	28	4	85	64	2,550	1	1	B7655 28 A
4	3,5	38	4	85	64	2,550	1	1	B7655 38 A
5	3,5	28	4	85	64	2,250	5	1	B7655 48 A
4	3,5	38	4	85	64	2,250	5	1	B7655 58 A

Type	Description	Key item	DEADBOLTS							ITEM			
			No.	Projection	Distance	Throws	Centre Distance	Faceplate	Backset	Unit weight	Pieces	Type	Dim. Hand

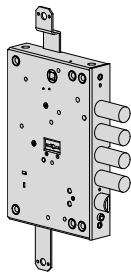

- VERSION WITH CONSTRUCTION KEY
- Deadbolt and latchbolt

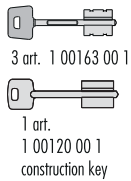

4	3,5	28	4	85	64	2,700	1	1	B7665 28 A
3	3,5	38	4	85	64	2,700	1	1	B7665 38 A
4	3,5	28	4	85	64	2,400	5	1	B7665 48 A
3	3,5	38	4	85	64	2,400	5	1	B7665 58 A



Technical features:

- The NEW CAMBIO FACILE system allows to re-key the lock by using a special re-keying tool and the keys, so that it is not necessary to disassemble the lock or any of its parts
- Zinc-plated steel case
- Zinc-plated high resistant satin steel faceplate
- Zinc-plated high resistant reversible latch
- Zinc-plated high resistant, steel deadbolts
- Pre-set for additional locking points
- Packing: 1 or 5 pcs. (industrial wrapping)
- Range developed according to 2 dimensional standards to meet any installation requirements
- Current absorption 3,1 A
- Voltage 12 V ac

Operation:

- VERSION WITH CONSTRUCTION KEY: the key operates the 4 throws

Hand:

A= Non-handed

Supplied as standard:

- Keys
- Re-keying tool
- Inside escutcheon item 1.06143.00.0
- Outside escutcheon item 1.06082.00.0

On request:

- **New manipulation and picking protection system: active on all six levers to block the lock in the event of burglary attempts**
- European Patent EP 2212493 B1

New CambioFacile

Type	Description	Key item	DEADBOLTS								ITEM				
			No.	Projection	Distance	Throws	Centre Distance	Faceplate	Backset	Unit weight	Pieces	Type	Dim.	Hand	Fin.

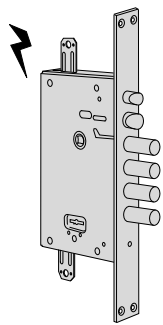

- CONSTRUCTION KEY VERSION
- Deadbolt and latch
- Electrically controlled deadlocking latch
- Slide item 1.06224.50.0

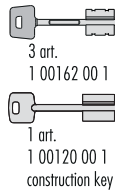

4	28	4	85	35	67	3,000	1	1	17685 28 A
4	28	4	85	35	67	2,850	5	1	17685 48 A

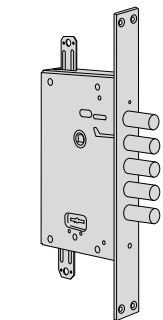
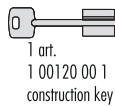

- CONSTRUCTION KEY VERSION
- Deadbolt only

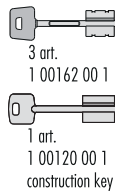

5	28	4	85	35	67	2,800	1	1	57675 28 A
5	28	4	85	35	67	2,600	5	1	57675 48 A

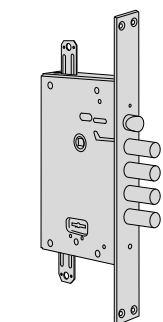
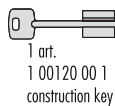

- CONSTRUCTION KEY VERSION
- Deadbolt and latch

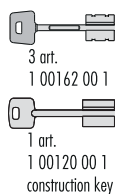

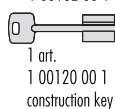

4	28	4	85	35	67	2,950	1	1	57685 28 A
4	28	4	85	35	67	2,650	5	1	57685 48 A

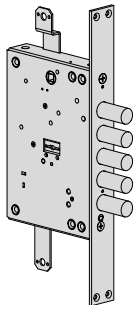

Type	Description	Key item	DEADBOLTS								ITEM				
			No.	Projection Distance	Throws	Centre Distance	Faceplate Backset	Unit weight Kg	Pieces	Type	Dim. Hand	Fin.	Peris. Spec.		





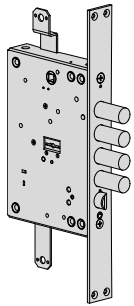

- VERSION WITH CONSTRUCTION KEY
- Deadbolt only

	5	28	4	85	35	67	2,800	1	1	B7675 28 A
	3 art. 1 00162 00 1	4	38	4	85	35	67	2,800	1	B7675 38 A
	5	28	4	85	35	67	2,500	5	1	B7675 48 A
	1 art. 1 00120 00 1 construction key	4	38	4	85	35	67	2,500	5	B7675 58 A

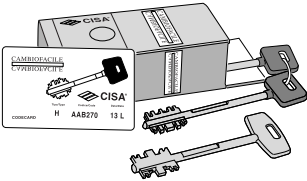
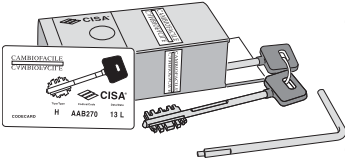
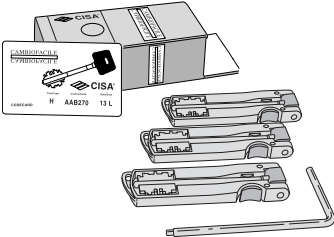

- VERSION WITH CONSTRUCTION KEY
- Deadbolt and latchbolt

	4	28	4	85	35	67	2,950	1	1	B7685 28 A
	3 art. 1 00162 00 1	3	38	4	85	35	67	2,950	1	B7685 38 A
	3	38	4	85	35	67	2,650	5	1	B7685 58 A
	1 art. 1 00120 00 1 construction key									

Type	Description	Unit weight Kg	Pieces	ITEM				
				Type	Dim.	Hand	Fin.	Pers. Spec.
 <p>CambioFacile</p>	<ul style="list-style-type: none"> • SUPPLIED AS STANDARD: 3 keys item 1.00162.00.1 1 change key 	0,135	1	1	06520	00	1	
	<ul style="list-style-type: none"> • SUPPLIED AS STANDARD: 5 keys item 1.00162.00.1 1 change key 	0,185	1	1	06520	01	1	
	<ul style="list-style-type: none"> • SUPPLIED AS STANDARD: 3 keys item 1.00163.00.1 1 change key 	0,145	1	1	06520	10	1	
	<ul style="list-style-type: none"> • SUPPLIED AS STANDARD: 5 keys item 1.00163.00.1 1 change key 	0,200	1	1	06520	11	1	
 <p>New CambioFacile</p>	<ul style="list-style-type: none"> • SUPPLIED AS STANDARD: 3 keys item 1.00162.00.1 1 change key 	0,130	1	1	06520	50	1	
	<ul style="list-style-type: none"> • SUPPLIED AS STANDARD: 5 keys item 1.00162.00.1 1 change key 	0,185	1	1	06520	51	1	
	<ul style="list-style-type: none"> • SUPPLIED AS STANDARD: 3 keys item 1.00163.00.1 1 change key 	0,130	1	1	06520	60	1	
	<ul style="list-style-type: none"> • SUPPLIED AS STANDARD: 5 keys item 1.00163.00.1 1 change key 	0,190	1	1	06520	61	1	
 <p>New CambioFacile</p>	<ul style="list-style-type: none"> • STANDARD SUPPLY: 3 keys item 1.00170.00.1 1 changing tool 	0,130	1	1	06520	55	1	
	<ul style="list-style-type: none"> • STANDARD SUPPLY: 3 keys item 1.00171.00.1 1 changing tool 	0,130	1	1	06520	65	1	
	<ul style="list-style-type: none"> • Group of construction keys for rekeyable armoured door locks NEW CAMBIO FACILE • SUPPLIED AS STANDARD: 1 construction key (Italian biting) 	0,033	1	1	06521	50	1	
	<ul style="list-style-type: none"> • Changing tool for NEW CAMBIO FACILE locks 	0,045	10	1	06522	00	0	



Technical features:

- Zinc-plated steel case
- Zinc-plated high resistant reversible latch
- Zinc-plated high resistant steel bolts
- Packing: 1 or 5 pcs. (industrial wrapping)
- Range developed according to 2 dimensional standards to meet any installation requirements
- Current absorption 3,1 A
- Voltage 12 V ac C

Supplied as standard:

- Keys
- Key guide item 1.06142.01.0
- Inside escutcheon item 1.06143.00.0
- Outside escutcheon item 1.06082.00.0

Hand:

0 = Non-handed

Operation:

- **VERSION WITH CONSTRUCTION KEY:**
the key operates the latch
- **VERSION WITH SERVICE KEY:**
the key operates the latch and first 2 throws



Type	Description	Key item	DEADBOLTS								ITEM			
			No.	Projection	Distance	Throws	Centre Distance	Faceplate	Backset	Unit weight	Pieces	Type	Dim.	Hand

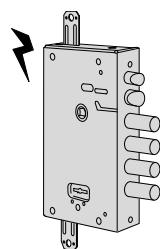

- Deadbolt and latch
- Electrically controlled deadlocking latch
- Slide item 1.06224.50.0
- Pre-set for additional locking points

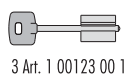

3 Art. 1 00123 00 1

4	3,5	28	4	85	64	2,570	1	1	17515 28 0
3	3,5	38	4	85	64	2,570	1	1	17515 38 0
4	3,5	28	4	85	64	2,270	5	1	17515 48 0
3	3,5	38	4	85	64	2,270	5	1	17515 58 0

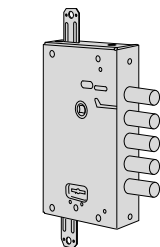

- Deadbolt only
- Pre-set for additional locking points

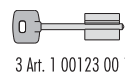

3 Art. 1 00123 00 1

5	3,5	28	4	85	64	2,380	1	1	57505 28 0
4	3,5	38	4	85	64	2,380	1	1	57505 38 0

- **SERVICE KEY VERSION**
- deadbolt only
- Pre-set for additional locking points

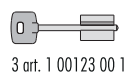

3 art. 1 00123 00 1



1 art. 1 00120 00 1
service key

5	3,5	28	4	85	64	2,400	1	1	57506 28 0
4	3,5	38	4	85	64	2,400	1	1	57506 38 0

- Deadbolt only
- Pre-set for additional locking points
- Cover plate item 1.06228.00.0

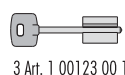

3 Art. 1 00123 00 1

5	43,5	28	4	85	64	2,580	1	1	57507 28 0
---	------	----	---	----	----	-------	---	---	------------

Type	Description	Key item	DEADBOLTS								ITEM				
			No.	Projection	Distance	Throws	Centre Distance	Faceplate	Backset	Unit weight Kg	Pieces	Type	Dim.	Hand	Fin.

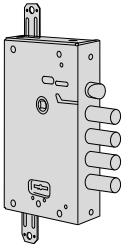

- Deadbolt and latch
- Pre-set for additional locking points

	4	3,5	28	4	85	64	2,430	1	1	57515 08 0
2 art. 1 00125 00 1										
	1									
1 art. 1 00120 00 1										

- Deadbolt and latch
- Pre-set for additional locking points

	4	3,5	25	4	85	64	2,430	1	1	57515 25 0
3 Art. 1 00123 00 1	4	3,5	27	4	85	64	2,600	1	1	57515 27 0
	4	3,5	28	4	85	64	2,600	1	1	57515 28 0
	3	3,5	32	4	85	64	2,430	1	1	57515 32 0
	3	3,5	38	4	85	64	2,430	1	1	57515 38 0
	4	3,5	28	4	85	64	2,260	5	1	57515 48 0

- CONSTRUCTION KEY VERSION
- Deadbolt and latch
- Pre-set for additional locking points

	4	3,5	28	4	85	64	2,450	5	1	57515 68 0
3 art. 1 00123 00 1										
	1									
1 art. 1 00120 00 1 construction key										

- SERVICE KEY VERSION
- Deadbolt and latch
- Pre-set for additional locking points

	4	3,5	28	4	85	64	2,450	1	1	57516 28 0
3 art. 1 00123 00 1	3	3,5	38	4	85	64	2,450	1	1	57516 38 0
	1									
1 art. 1 00120 00 1 service key										

- Deadbolt and latch
- Pre-set for additional locking points
- Cover plate item 1.06228.00.0

	4	43,5	28	4	85	64	2,630	1	1	57517 28 0
3 Art. 1 00123 00 1	3	43,5	38	4	85	64	2,630	1	1	57517 38 0

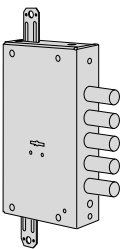

- Deadbolt only
- Pre-set for additional locking points

	5	3,5	25	4	85	64	2,380	1	1	87505 25 0
3 Art. 1 00123 00 1	5	3,5	28	4	85	64	2,380	1	1	87505 28 0
	4	3,5	38	4	85	64	2,380	1	1	87505 38 0
	5	3,5	28	4	85	64	2,380	5	1	87505 48 0
	4	3,5	38	4	85	64	2,380	5	1	87505 58 0

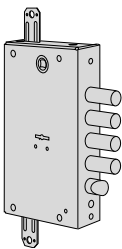

- Deadbolt and latch
- Pre-set for additional locking points

	4	3,5	25	4	85	64	2,430	1	1	87515 25 0
3 Art. 1 00123 00 1	4	3,5	28	4	85	64	2,800	1	1	87515 28 0
	3	3,5	38	4	85	64	2,685	1	1	87515 38 0
	4	3,5	28	4	85	64	2,590	5	1	87515 48 0
	3	3,5	38	4	85	64	2,500	5	1	87515 58 0



Technical features:

- Zinc-plated steel case
- Zinc-plated high resistant satin steel faceplate
- Zinc-plated high resistant reversible latch
- Zinc-plated high resistant steel deadbolts
- Packing: 1 or 5 pcs. (industrial wrapping)
- Range developed according to 2 dimensional standards to meet any installation requirements
- Current absorption 3,1 A
- Voltage 12 V ac CE

Supplied as standard:

- Keys
- Inside escutcheon item 1.06143.02.0
- Outside escutcheon item 1.06082.01.0

Hand:

0 = Non-handed

Operation:

- **VERSION WITH CONSTRUCTION KEY:**
the key operates the latch
- **VERSION WITH SERVICE KEY:**
the key operates the latch and first 2 throws

Type	Description	Key item	DEADBOLTS							ITEM	
			No.	Projection Distance	Throws	Centre Distance	Faceplate Backset	Unit weight Kg	Pieces	Type	Dim. Hand Fin. Pars. Spec.

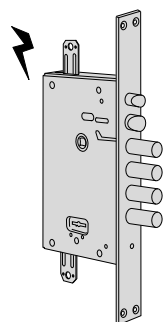

- Deadbolt and latch
- Electrically controlled deadlocking latch
- Slide item 1.06224.50.0
- Pre-set for additional locking points

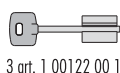

3 art. 1 00122 00 1

4	28	4	85	35	67	2,840	1	1 17535 28 0
4	28	4	85	35	67	2,540	5	1 17535 48 0

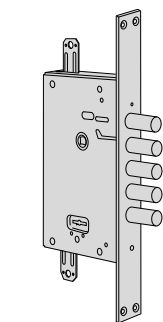

- Deadbolt only
- Pre-set for additional locking points

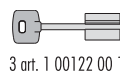

3 art. 1 00122 00 1

5	28	4	85	35	67	2,750	1	1 57525 28 0
---	----	---	----	----	----	-------	---	--------------

- **SERVICE KEY VERSION**
- Deadbolt only
- Pre-set for additional locking points

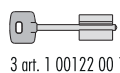



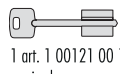





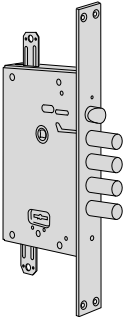

3 art. 1 00122 00 1

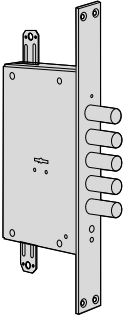

1 art. 1 00121 00 1 service key

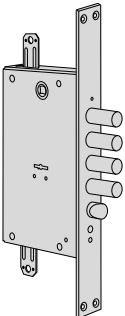
5	28	4	85	35	67	2,600	1	1 57526 28 0
---	----	---	----	----	----	-------	---	--------------

Type	Description	Key item	DEADBOLTS								ITEM						
			No.	Projection	Distance	Throws	Centre Distance	Faceplate	Backset	Unit weight Kg	Pieces	Type	Dim.	Hand	Fin.	Pers.	Spec.
	<ul style="list-style-type: none"> • Deadbolt only • Pre-set for additional locking points 		4	28	4	85	35	67	2,780	1	1	57535	28	0			
		3 art. 1.00122.00.1	4	28	4	85	35	67	2,500	5	1	57535	48	0			
	<ul style="list-style-type: none"> • CONSTRUCTION KEY VERSION • Deadbolt and latch • Pre-set for additional locking points 		4	28	4	85	35	67	2,520	5	1	57535	68	0			
		3 art. 1.00122.00.1	4	28	4	85	35	67	2,800	1	1	57535	88	0			
			1 art. 1.00121.00.1	construction key													
	<ul style="list-style-type: none"> • SERVICE KEY VERSION • Deadbolt and latch • Pre-set for additional locking points 		5	28	4	85	35	67	2,800	1	1	57536	28	0			
3 art. 1.00122.00.1			1 art. 1.00121.00.1	service key													
	<ul style="list-style-type: none"> • Deadbolt only • Pre-set for additional locking points 		5	28	4	85	35	67	2,580	1	1	87525	28	0			
		3 art. 1.00122.00.1	5	38	4	85	35	67	2,580	1	1	87525	38	0			
		5	28	4	85	35	67	2,580	5	1	87525	48	0				
		5	38	4	85	35	67	2,580	5	1	87525	58	0				
	<ul style="list-style-type: none"> • Deadbolt and latch • Pre-set for additional locking points 		4	28	4	85	35	67	3,100	1	1	87535	28	0			
		3 art. 1.00122.00.1	4	38	4	85	35	67	2,780	1	1	87535	38	0			
		4	28	4	85	35	67	2,600	5	1	87535	48	0				
		4	38	4	85	35	67	2,600	5	1	87535	58	0				
	<p>TO BE DISCONTINUED</p> <p>art. 1.87535.38.0</p> <p>art. 1.87535.48.0</p>																



Technical features:

- Zinc-plated steel case
- Zinc-plated high resistant steel deadbolts:
n° 4 for the lower lock
n° 1 for the upper lock
- Zinc-plated high resistant reversible latch
- Can be fitted with additional locking points
- Packing: 1 or 5 pcs. (industrial wrapping)
- Range developed according to 2 dimensional standards to meet any installation requirements
- Current absorption 3,1 A
- Voltage 12 V ac

Operation:

- **VERSION WITH SECURITY FUNCTION:** the upper lock blocks the lower lock when the latter is locked
- **VERSION WITH SERVICE KEY:** the upper lock key operates the latch and upper deadbolt
- **VERSION WITH SERVICE KEY AND OPENING LIMITING DEVICE:** the upper lock key operates the latch and

upper deadbolt; the opening limiting device is activated by operating the first throw of the upper lock

Supplied as standard:

- Keys (only for those items with double-bit key locks)

Standards:

- **New manipulation and picking protection system on NEW CAMBIO FACILE locks:** active on all six levers to block the lock in the event of burglary attempts

European Patent EP 2212493 B1

Cylinder to be ordered separately



Type	Description	Key item	DEADBOLTS							ITEM			
			No.	Projection	Distance	Throws	Centre Distance	Faceplate	Backset	Unit weight	Pieces	Type	Dim.

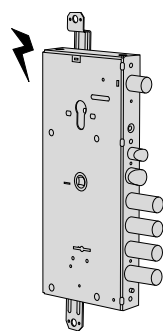

- VERSION WITH SERVICE LOCK
- 2 throw secondary cylinder lock
- Double bitted 6 lever main lock
- Electric operation self locking latchbolt
- Slide item 1.06224.50.0

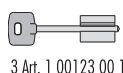

3 Art. 1 00123 00 1

3,5	28	85	64	3,100	1	1	17766 28 0
3,5	28	85	64	2,880	5	1	17766 48 0

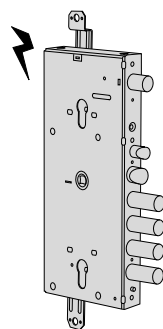





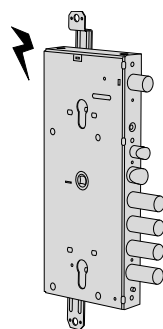

- VERSION WITH SERVICE LOCK
- 2 throw secondary cylinder lock
- 2 throw main cylinder lock
- Electric operation self locking latchbolt
- Slide item 1.06224.50.0

3,5	28	85	64	2,900	1	1	16766 28 0
3,5	28	85	64	3,140	5	1	16766 48 0

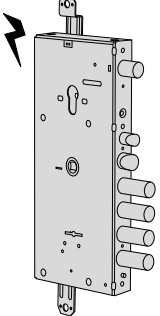

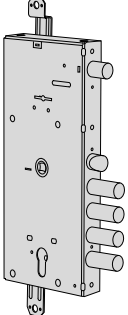
- VERSION WITH SERVICE LOCK
- 2-throw secondary cylinder lock
- 2-throw main cylinder lock
- **FITTED WITH A BLOCKING DEVICE WHICH IS ACTIVATED IF THE CYLINDER IS EXTRACTED (REVOLUTION PRO)**
- Electrically controlled dead-locking latch
- Slide item 1.06224.50.0

3,5	28	85	64	2,900	1	1	16766 28 B
3,5	28	85	64	3,140	5	1	16766 48 B

Type	Description	Key item	DEADBOLTS							ITEM								
			No.	Projection	Distance	Throws	Centre Distance	Faceplate	Backset	Unit weight	Pieces	Type	Dim.	Hand	Fin.	Pers.	Spec.	
 <ul style="list-style-type: none"> • VERSION WITH SERVICE LOCK • 2 throw secondary cylinder lock • Double bit 6 lever NEW CAMBIO FACILE main lock with construction key, 4 throws • Electric operation self locking latchbolt • Slide item 1.06224.50.0 		 3 art. 1 00163 00 1	3,5	28	85	64	3,500	1	1	17966	28	A						
			3,5	28	85	64	3,200	5	1	17966	48	A						
			 1 art. 1 00120 00 1 construction key															
 <ul style="list-style-type: none"> • VERSION WITH SECURITY LOCK (interlocked locks) the secondary lock can only be operated when the main lock is in its closed position • Double bit 6 lever secondary lock, 2 throws • Cylinder main lock, 2 throws • VERSION WITH SECURITY LOCK (interlocked locks) the secondary lock can only be operated whrn the main lock is in its closed position • Double bit 6 lever secondary lock, 2 throws • Main cylinder lock, 2 throws • FITTED WITH A BLOCKING DEVICE WHICH IS ACTIVATED IF THE CYLINDER IS EXTRACTED (REVOLUTION PRO) • VERSION WITH SERVICE LOCK • Double bit 6 lever secondary lock, 2 throws • Cylinder main lock, 2 throws • VERSION WITH SERVICE LOCK • Double bit 6 lever secondary lock, 2 throws • Main cylinder lock, 2 throws • FITTED WITH A BLOCKING DEVICE WHICH IS ACTIVATED IF THE CYLINDER IS EXTRACTED (REVOLUTION PRO) 		 3 Art. 1 00123 00 1	3,5	28	85	64	3,100	1	1	56715	28	0						
			3,5	28	85	64	2,800	5	1	56715	48	0						
		 3 Art. 1 00123 00 1																
		 3 Art. 1 00123 00 1																
		 3 Art. 1 00123 00 1																

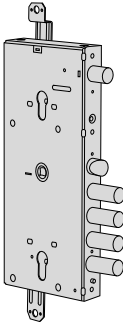
Type	Description	Key item	DEADBOLTS							ITEM			
			No.	Projection Distance	Throws	Centre Distance	Faceplate Backset	Unit weight Kg	Pieces	Type	Dim. Hand	Fin.	Pers. Spec.
	<ul style="list-style-type: none"> • VERSION WITH SECURITY LOCK (interlocked locks) the secondary lock can only be operated when the main lock is in its closed position • Secondary cylinder lock, 2 throws • Main cylinder lock, 2 throws 		3,5	28	85	64	2,900	1	1	56765	28	0	
			3,5	28	85	64	3,100	5	1	56765	48	0	
	<ul style="list-style-type: none"> • VERSION WITH SECURITY LOCK (interlocked locks) the secondary lock can only be operated when the main lock is in its closed position • Secondary cylinder lock, 2 throws • Main cylinder lock, 2 throws • FITTED WITH A BLOCKING DEVICE WHICH IS ACTIVATED IF THE CYLINDER IS EXTRACTED (REVOLUTION PRO) 		3,5	28	85	64	2,900	1	1	56765	28	B	
			3,5	28	85	64	3,100	5	1	56765	48	B	
	<ul style="list-style-type: none"> • VERSION WITH SERVICE LOCK • Secondary cylinder lock, 2 throws • Main cylinder lock, 2 throws 		3,5	28	85	64	2,900	1	1	56766	28	0	
			3,5	28	85	64	3,100	5	1	56766	48	0	
	<ul style="list-style-type: none"> • VERSION WITH SERVICE LOCK • Secondary cylinder lock, 2 throws • Main cylinder lock, 2 throws • FITTED WITH A BLOCKING DEVICE WHICH IS ACTIVATED IF THE CYLINDER IS EXTRACTED (REVOLUTION PRO) 		3,5	28	85	64	2,900	1	1	56766	28	B	
			3,5	28	85	64	3,100	5	1	56766	48	B	

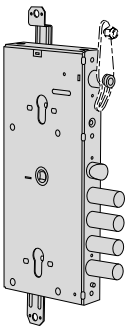
Type	Description	Key item	DEADBOLTS							ITEM						
			No.	Projection	Distance	Throws	Centre Distance	Facaplate	Backset	Unit weight	Pieces	Type	Dim.	Hand	Fin.	Pers.
	<ul style="list-style-type: none"> • VERSION WITH SERVICE LOCK AND OPENING LIMITING DEVICE, OPERATED VIA THE CYLINDER 		3,5	28	85	64	2,900	1	1	56767	28	0				
			3,5	28	85	64	2,600	5	1	56767	48	0				
	<ul style="list-style-type: none"> • Secondary cylinder lock, 2 throws • Main cylinder lock, 2 throws • TO ORDER SEPARATELY: Limiting device chain item 1.06421.10.1/2 		3,5	28	85	64	2,900	1	1	56767	28	B				
			3,5	28	85	64	2,600	5	1	56767	48	B				
	<ul style="list-style-type: none"> • Secondary cylinder lock, 2 throws • Main cylinder lock, 2 throws • FITTED WITH A BLOCKING DEVICE WHICH IS ACTIVATED IF THE CYLINDER IS EXTRACTED (REVOLUTION PRO) • TO ORDER SEPARATELY: Limiting device chain item 1.06421.10.1/2 		3,5	28	85	64	2,900	1	1	56768	28	0				
			3,5	28	85	64	3,140	5	1	56768	48	0				
	<ul style="list-style-type: none"> • Secondary thumb turn lock, 2 throws • Main cylinder lock, 2 throws • TO ORDER SEPARATELY: Limiting device chain item 1.06421.10.1/2 		3,5	28	85	64	2,900	1	1	56768	28	B				
			3,5	28	85	64	3,140	5	1	56768	48	B				
	<ul style="list-style-type: none"> • Secondary thumb turn lock, 2 throws • Main cylinder lock, 2 throws • FITTED WITH A BLOCKING DEVICE WHICH IS ACTIVATED IF THE CYLINDER IS EXTRACTED (REVOLUTION PRO) • TO ORDER SEPARATELY: Limiting device chain item 1.06421.10.1/2 		3,5	28	85	64	2,900	1	1	56768	28	B				
			3,5	28	85	64	3,140	5	1	56768	48	B				

Type	Description	Key item	DEADBOLTS						ITEM				
			No.	Projection Distance	Throws	Centre Distance	Faceplate Backset	Unit weight Kg	Pieces	Type	Dim. Hand	Fin.	Pers. Spec.

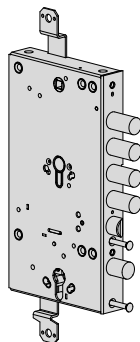

- VERSION WITH SECURITY LOCK (independent locks) the secondary lock can be operated also when the main lock is in its open position
- Secondary cylinder lock, 2 throws
- Main cylinder lock, 2 throws

3,5	28	85	64	2,900	1	1	B6764 28 0
3,5	38	85	64	2,900	1	1	B6764 38 0
3,5	28	85	64	3,100	5	1	B6764 48 0
3,5	38	85	64	3,100	5	1	B6764 58 0

- VERSION WITH SECURITY LOCK (interlocked locks) the secondary lock can only be operated when the main lock is in its closed position
- Secondary cylinder lock, 2 throws
- Main cylinder lock, 2 throws

3,5	28	85	64	2,900	1	1	B6765 28 0
3,5	38	85	64	2,900	1	1	B6765 38 0
3,5	28	85	64	3,100	5	1	B6765 48 0
3,5	38	85	64	3,100	5	1	B6765 58 0

- VERSION WITH SERVICE LOCK
- Secondary cylinder lock, 2 throws
- Main cylinder lock, 2 throws

3,5	28	85	64	2,900	1	1	B6766 28 0
3,5	38	85	64	2,900	1	1	B6766 38 0
3,5	38	85	64	3,100	5	1	B6766 58 0

- VERSION WITH SERVICE LOCK
- Secondary cylinder lock, 2 throws
- Main cylinder lock, 2 throws
- FITTED WITH A BLOCKING DEVICE WHICH IS ACTIVATED IF THE CYLINDER IS EXTRACTED (REVOLUTION PRO)

3,5	28	85	64	2,900	1	1	B6766 28 B
3,5	38	85	64	2,900	1	1	B6766 38 B
3,5	38	85	64	3,100	1	1	B6766 48 B
3,5	38	85	64	3,100	5	1	B6766 58 B

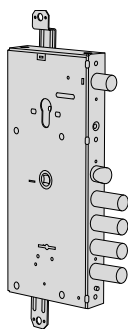

- VERSION WITH SECURITY LOCK (interlocked locks) the secondary lock can only be operated when the main lock is in its closed position
- Secondary cylinder lock, 2 throws
- Double bit 6 lever main lock, 4 throws

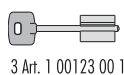

3,5	28	85	64	3,100	1	1	57765 28 0
3,5	28	85	64	2,900	5	1	57765 48 0

- VERSION WITH SERVICE LOCK
- Secondary cylinder lock, 2 throws
- Double bit 6 lever main lock, 4 throws

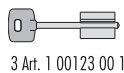

3,5	28	85	64	3,100	1	1	57766 28 0
3,5	28	85	64	2,900	5	1	57766 48 0

Type	Description	Key item	DEADBOLTS							ITEM				
			No.	Projection	Distance	Throws	Centre Distance	Faceplate	Backset	Unit weight	Pieces	Type	Dim.	Hand

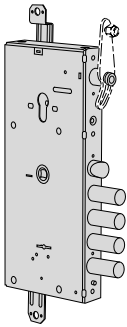

- VERSION WITH SERVICE LOCK AND OPENING LIMITING DEVICE, OPERATED VIA THE CYLINDER
- Secondary cylinder lock, 2 throws
- Double bit 6 lever main lock, 4 throws
- TO ORDER SEPARATELY:
Limiting device chain item 1.06421.10.1/2

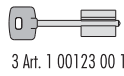

3,5	28	85	64	3,100	1	1	57767 28 0
3,5	28	85	64	2,900	5	1	57767 48 0

- VERSION WITH SERVICE LOCK AND OPENING LIMITING DEVICE, OPERATED VIA THE INSIDE THUMB TURN ONLY
- Secondary thumb turn lock, 2 throws
- Double bit 6 lever main lock, 4 throws
- TO ORDER SEPARATELY:
Limiting device chain item 1.06421.10.1/2

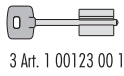

3,5	28	85	64	3,100	1	1	57768 28 0
-----	----	----	----	-------	---	---	-------------------

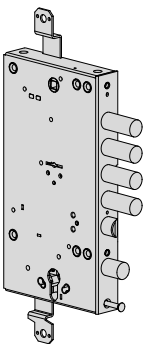

- VERSION WITH SECURITY LOCK (independent locks) the secondary lock can be operated also when the main lock is in its open position
- Secondary cylinder lock, 2 throws
- Double bit 6 lever main lock, 4 throws

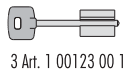

3,5	28	85	64	3,100	1	1	B7764 28 0
3,5	38	85	64	3,100	1	1	B7764 38 0
3,5	28	85	64	2,900	5	1	B7764 48 0
3,5	38	85	64	2,900	5	1	B7764 58 0

- VERSION WITH SECURITY LOCK (interlocked locks) the secondary lock can only be operated when the main lock is in its closed position
- Secondary cylinder lock, 2 throws
- Double bit 6 lever main lock, 4 throws

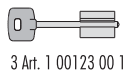

3,5	38	85	64	3,100	1	1	B7765 38 0
3,5	28	85	64	2,900	5	1	B7765 48 0
3,5	38	85	64	2,900	5	1	B7765 58 0

- VERSION WITH SERVICE LOCK
- Secondary cylinder lock, 2 throws
- Double bit 6 lever main lock, 4 throws

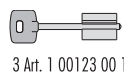

3,5	28	85	64	3,100	1	1	B7766 28 0
3,5	38	85	64	3,100	1	1	B7766 38 0
3,5	28	85	64	2,900	5	1	B7766 48 0
3,5	38	85	64	2,900	5	1	B7766 58 0

Type	Description	Key item	DEADBOLTS							ITEM				
			No.	Projection Distance	Throws	Centre Distance	Faceplate Backset	Unit weight Kg	Pieces	Type	Dim. Hand	Fin.	Pers. Spec.	

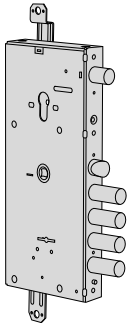

- VERSION WITH SECURITY LOCK (interlocked locks) the secondary lock can only be operated when the main lock is in its closed position
- Secondary cylinder lock, 2 throws
- Double bit 6 lever main lock NEW CAMBIO FACILE, 4 throws, with construction key

 3 art. 1 00163 00 1	3,5	28	85	64	3,400	1	1 57965 28 A
	3,5	28	85	64	3,100	5	1 57965 48 A
 1 art. 1 00120 00 1 construction key							

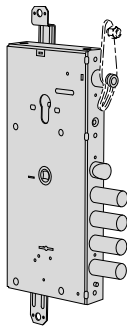

- VERSION WITH SERVICE LOCK AND OPENING LIMITING DEVICE, OPERATED VIA THE CYLINDER
- Secondary cylinder lock, 2 throws
- Double bit 6 lever main lock NEW CAMBIO FACILE, 4 throws, with construction key
- TO ORDER SEPARATELY:
Limiting device chain item 1.06421.10.1/2

 3 art. 1 00163 00 1	3,5	28	85	64	3,400	1	1 57967 28 A
 1 art. 1 00120 00 1 construction key							

- VERSION WITH SERVICE LOCK AND OPENING LIMITING DEVICE, OPERATED VIA THE INSIDE THUMB TURN ONLY
- Secondary thumb turn lock, 2 throws
- Double bit 6 lever main lock NEW CAMBIO FACILE, 4 throws, with construction key
- TO ORDER SEPARATELY:
Limiting device chain item 1.06421.10.1/2

 3 art. 1 00163 00 1	3,5	28	85	64	3,100	5	1 57968 48 A
 1 art. 1 00120 00 1 construction key							

Type	Description	Key item	DEADBOLTS							ITEM				
			No.	Projection	Distance	Throws	Centre Distance	Facaplate	Backset	Unit weight	Pieces	Type	Dim.	Hand

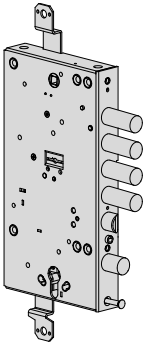

- **VERSION WITH SECURITY LOCK (independent locks)** the secondary lock can be operated also when the main lock is in its open position
- Secondary cylinder lock, 2 throws
- Double bit 6 lever main lock, 4 throws, NEW CAMBIO FACILE, with construction key

	3,5	28	85	64	3,400	1	1	B7964 28 A
	3,5	38	85	64	3,400	1	1	B7964 38 A
3 art. 1 00163 00 1	3,5	28	85	64	3,100	5	1	B7964 48 A
	3,5	38	85	64	3,100	5	1	B7964 58 A
1 art. 1 00120 00 1 construction key								

- **VERSION WITH SECURITY LOCK (interlocked locks)** the secondary lock can only be operated when the main lock is in its closed position
- Secondary cylinder lock, 2 throws
- Double bit 6 lever main lock NEW CAMBIO FACILE, 4 throws, with construction key

	3,5	28	85	64	3,400	1	1	B7965 28 A
	3,5	38	85	64	3,400	1	1	B7965 38 A
3 art. 1 00163 00 1	3,5	28	85	64	3,100	5	1	B7965 48 A
	3,5	38	85	64	3,100	5	1	B7965 58 A
1 art. 1 00120 00 1 construction key								

- **VERSION WITH SERVICE LOCK**
- Secondary cylinder lock, 2 throws
- Double bit 6 lever main lock, NEW CAMBIO FACILE, 4 throws, with construction key

	3,5	28	85	64	3,400	1	1	B7966 28 A
	3,5	38	85	64	3,400	1	1	B7966 38 A
3 art. 1 00163 00 1	3,5	28	85	64	3,100	5	1	B7966 48 A
	3,5	38	85	64	3,100	5	1	B7966 58 A
1 art. 1 00120 00 1 construction key								



Technical features:

- Zinc-plated steel case
- Zinc-plated high resistant satin steel faceplate
- Zinc-plated high resistant steel deadbolts: n° 4 for the lower lock n° 1 for the upper lock
- Zinc-plated high resistant reversible latch
- Can be fitted with additional locking points
- Packing: 1 or 5 pcs. (industrial wrapping)
- Range developed according to 2 dimensional standards to meet any installation requirements
- Current absorption 3,1 A
- Voltage 12 V ac

Operation:

- **VERSION WITH SECURITY FUNCTION:** the upper lock blocks the lower lock when the latter is locked

- **VERSION WITH SERVICE KEY:** the upper lock key operates the latch and upper deadbolt
- **VERSION WITH SERVICE KEY AND OPENING LIMITING DEVICE:** the upper lock key operates the latch and upper deadbolt; the opening limiting device is activated by operating the first throw of the upper lock

Cylinder to be ordered separately



Supplied as standard:

- Keys (only for those items with double-bit key locks)

Standards:

- **New manipulation and picking protection system on NEW CAMBIO FACILE locks:** active on all six levers to block the lock in the event of burglary attempts
European Patent EP 2212493 B1

Type	Description	Key item	DEADBOLTS							ITEM			
			No.	Projection Distance	Throws	Centre Distance	Faceplate Backset	Unit weight Kg	Pieces	Type	Dim. Hand	Fin.	Pers. Spec.

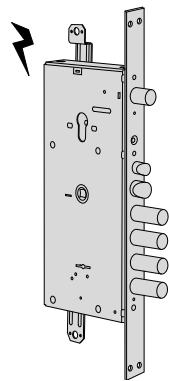

- VERSION WITH SERVICE LOCK
- 2 throw secondary cylinder lock
- Double bitted 6 lever main lock
- Electric operation self locking latchbolt
- Slide item 1.06224.50.0

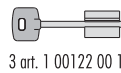

28	85	35	67	3,600	1	1	17786 28 0
28	85	35	67	3,300	5	1	17786 48 0

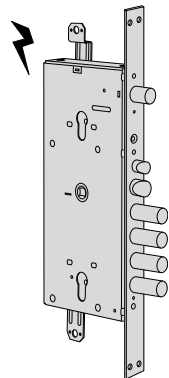



- VERSION WITH SERVICE LOCK
- 2 throw secondary cylinder lock
- 2 throw main cylinder lock
- Electric operation self locking latchbolt
- Slide item 1.06224.50.0

TO BE DISCONTINUED

28	85	35	67	3,800	1	1	16786 28 0
28	85	35	67	3,500	5	1	16786 48 0

- VERSION WITH SERVICE LOCK
- 2-throw secondary cylinder lock
- 2-throw main cylinder lock
- **FITTED WITH A BLOCKING DEVICE WHICH IS ACTIVATED IF THE CYLINDER IS EXTRACTED (REVOLUTION PRO)**
- Electrically controlled dead locking latch
- Slide item 1.06224.50.0

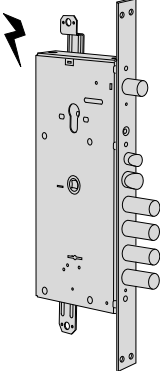
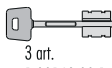
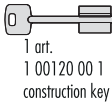
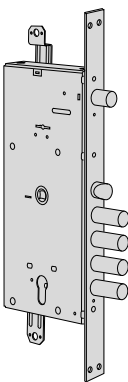
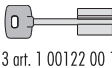
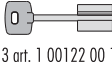
28	85	35	67	3,800	1	1	16786 28 B
28	85	35	67	3,500	5	1	16786 48 B

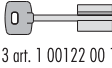
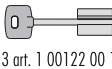
Type	Description	Key item	DEADBOLTS								ITEM						
			No.	Projection	Distance	Throws	Centre Distance	Faceplate	Backset	Unit weight	Pieces	Type	Dim.	Hand	Fin.	Pers.	Spec.
	<ul style="list-style-type: none"> • VERSION WITH SERVICE LOCK • 2 throw secondary cylinder lock • Double bitted 6 lever main lock NEW CAMBIO FACILE, 4 throws, with construction key • Electric operation self locking latchbolt • Slide item 1.06224.50.0 	 3 art. 1 00162 00 1	28	85	35	67	3,735	1	1	17986	28	A					
			28	85	35	67	3,700	5	1	17986	48	A					
		 1 art. 1 00120 00 1 construction key															
	TO BE DISCONTINUED																
	<ul style="list-style-type: none"> • VERSION WITH SECURITY LOCK (interlocked locks) the secondary lock can only be operated when the main lock is in its closed position • Double bit 6 lever secondary lock, 2 throws • Cylinder main lock, 2 throws 	 3 art. 1 00122 00 1	28	85	35	67	3,800	1	1	56735	28	0					
			28	85	35	67	3,500	5	1	56735	48	0					
	<ul style="list-style-type: none"> • VERSION WITH SECURITY LOCK (interlocked locks) the secondary lock can only be operated whrn the main lock is in its closed position • Double bit 6 lever secondary lock, 2 throws • Main cylinder lock, 2 throws • FITTED WITH A BLOCKING DEVICE WHICH IS ACTIVATED IF THE CYLINDER IS EXTRACTED (REVOLUTION PRO) 	 3 art. 1 00122 00 1	28	85	35	67	3,800	1	1	56735	28	B					
			28	85	35	67	3,500	5	1	56735	48	B					
	<ul style="list-style-type: none"> • VERSION WITH SERVICE LOCK • Double bitted 6 lever secondary lock, 2 throws • Cylinder main lock, 2 throws 	 3 art. 1 00122 00 1	28	85	35	67	3,800	1	1	56736	28	0					
			28	85	35	67	3,500	5	1	56736	48	0					
	<ul style="list-style-type: none"> • VERSION WITH SERVICE LOCK • Double bit 6 lever secondary lock, 2 throws • Main cylinder lock, 2 throws • FITTED WITH A BLOCKING DEVICE WHICH IS ACTIVATED IF THE CYLINDER IS EXTRACTED (REVOLUTION PRO) 	 3 art. 1 00122 00 1	28	85	35	67	3,800	1	1	56736	28	B					
			28	85	35	67	3,500	5	1	56736	48	B					

Type	Description	Key item	DEADBOLTS							ITEM			
			No.	Projection Distance	Throws	Centre Distance	Faceplate Backset	Unit weight Kg	Pieces	Type	Dim. Hand	Fin.	Pers. Spec.
	<ul style="list-style-type: none"> • VERSION WITH SECURITY LOCK (interlocked locks) the secondary lock can only be operated when the main lock is in its closed position • Secondary cylinder lock, 2 throws • Main cylinder lock, 2 throws 		28	85	35	67	3,600	1	1	56785	28	0	
			28	85	35	67	3,300	5	1	56785	48	0	
	<ul style="list-style-type: none"> • VERSION WITH SECURITY LOCK (interlocked locks) the secondary lock can only be operated when the main lock is in its closed position • Secondary cylinder lock, 2 throws • Main cylinder lock, 2 throws • FITTED WITH A BLOCKING DEVICE WHICH IS ACTIVATED IF THE CYLINDER IS EXTRACTED (REVOLUTION PRO) 		28	85	35	67	3,600	1	1	56785	28	B	
			28	85	35	67	3,300	5	1	56785	48	B	
	<ul style="list-style-type: none"> • VERSION WITH SERVICE LOCK • 2 throw secondary cylinder lock • 2 throw main cylinder lock 		28	85	35	67	3,600	1	1	56786	28	0	
			28	85	35	67	3,300	5	1	56786	48	0	
	<ul style="list-style-type: none"> • VERSION WITH SERVICE LOCK • Secondary cylinder lock, 2 throws • Main cylinder lock, 2 throws • FITTED WITH A BLOCKING DEVICE WHICH IS ACTIVATED IF THE CYLINDER IS EXTRACTED (REVOLUTION PRO) 		28	85	35	67	3,600	1	1	56786	28	B	
			28	85	35	67	3,300	5	1	56786	48	B	

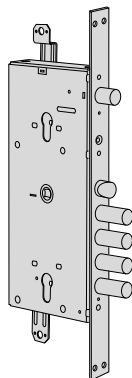

Type	Description	Key item	DEADBOLTS							ITEM						
			No.	Projection	Distance	Throws	Centre Distance	Faceplate	Backset	Unit weight Kg	Pieces	Type	Dim.	Hand	Fin.	Pers.
	<ul style="list-style-type: none"> • VERSION WITH SERVICE LOCK AND OPENING LIMITING DEVICE, OPERATED VIA THE CYLINDER • Secondary cylinder lock, 2 throws • Main cylinder lock, 2 throws • TO ORDER SEPARATELY: Limiting device chain item 1.06421.10.1/2 		28	85	35	67	3,600	1	1	56787	28	0				
	<ul style="list-style-type: none"> • VERSION WITH SERVICE LOCK AND OPENING LIMITING DEVICE • Secondary cylinder lock, 2 throws • Main cylinder lock, 2 throws • FITTED WITH A BLOCKING DEVICE WHICH IS ACTIVATED IF THE CYLINDER IS EXTRACTED (REVOLUTION PRO) • TO ORDER SEPARATELY: Limiting device chain item 1.06421.10.1/2 		28	85	35	67	3,600	1	1	56787	28	B				
	<ul style="list-style-type: none"> • VERSION WITH SERVICE LOCK AND OPENING LIMITING DEVICE, OPERATED VIA THE INSIDE THUMB TURN ONLY • Secondary thumb turn lock, 2 throws • Main cylinder lock, 2 throws • TO ORDER SEPARATELY: Limiting device chain item 1.06421.10.1/2 	28	85	35	67	3,400	1	1	56788	28	0					
		28	85	35	67	3,400	5	1	56788	48	0					
<ul style="list-style-type: none"> • VERSION WITH SERVICE LOCK AND OPENING LIMITING DEVICE, OPERATED VIA THE INSIDE THUMB TURN ONLY • Secondary thumb turn lock, 2 throws • Main cylinder lock, 2 throws • FITTED WITH A BLOCKING DEVICE WHICH IS ACTIVATED IF THE CYLINDER IS EXTRACTED (REVOLUTION PRO) • TO ORDER SEPARATELY: Limiting device chain item 1.06421.10.1/2 	28	85	35	67	3,400	1	1	56788	28	B						
	28	85	35	67	3,400	5	1	56788	48	B						

Type	Description	Key item	DEADBOLTS							ITEM				
			No.	Projection Distance	Throws	Centre Distance	Faceplate Backset	Unit weight Kg	Pieces	Type	Dim.	Hand	Fin.	Pers. Spec.

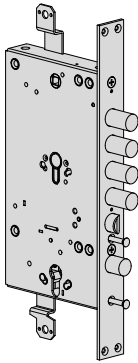

- VERSION WITH SECURITY LOCK (independent locks) the secondary lock can be operated also when the main lock is in its open position
- Secondary cylinder lock, 2 throws
- Main cylinder lock, 2 throws

TO BE DISCONTINUED
art. 1.B6784.28.0

28	85	35	67	3,600	1	1	B6784 28 0
38	85	35	67	3,600	1	1	B6784 38 0
28	85	35	67	3,300	5	1	B6784 48 0
38	85	35	67	3,300	5	1	B6784 58 0

- VERSION WITH SECURITY LOCK (interlocked locks) the secondary lock can only be operated when the main lock is in its closed position
- Secondary cylinder lock, 2 throws
- Main cylinder lock, 2 throws

28	85	35	67	3,600	1	1	B6785 28 0
38	85	35	67	3,600	1	1	B6785 38 0
28	85	35	67	3,300	5	1	B6785 48 0
38	85	35	67	3,300	5	1	B6785 58 0

- VERSION WITH SERVICE LOCK
- 2 throw secondary cylinder lock
- 2 throw main cylinder lock

28	85	35	67	3,600	1	1	B6786 28 0
38	85	35	67	3,600	1	1	B6786 38 0
28	85	35	67	3,300	5	1	B6786 48 0
38	85	35	67	3,300	5	1	B6786 58 0

- VERSION WITH SERVICE LOCK
- Secondary cylinder lock, 2 throws
- Main cylinder lock, 2 throws

28	85	35	67	3,600	1	1	B6786 28 B
38	85	35	67	3,600	1	1	B6786 38 B
28	85	35	67	3,300	5	1	B6786 48 B
38	85	35	67	3,300	5	1	B6786 58 B

- **FITTED WITH A BLOCKING DEVICE WHICH IS ACTIVATED IF THE CYLINDER IS EXTRACTED (REVOLUTION PRO)**

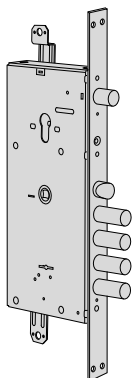

- VERSION WITH SECURITY LOCK (interlocked locks) the secondary lock can only be operated when the main lock is in its closed position
- Secondary cylinder lock, 2 throws
- Double bit 6 lever main lock, 4 throws

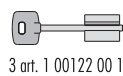

3 art. 1 00122 00 1

28	85	35	67	3,600	1	1	57785 28 0
28	85	35	67	3,300	5	1	57785 48 0

- VERSION WITH SERVICE LOCK
- Secondary cylinder lock, 2 throws
- Double bit 6 lever main lock, 4 throws

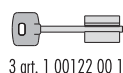

3 art. 1 00122 00 1

28	85	35	67	3,600	1	1	57786 28 0
28	85	35	67	3,300	5	1	57786 48 0

Type	Description	Key item	DEADBOLTS							ITEM				
			No.	Projection	Distance	Throws	Centre Distance	Faceplate	Backset	Unit weight Kg	Pieces	Type	Dim.	Hand

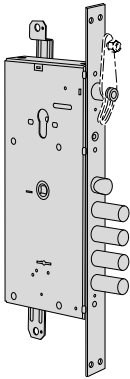

- VERSION WITH SERVICE LOCK AND OPENING LIMITING DEVICE, OPERATED VIA THE CYLINDER
- Secondary cylinder lock, 2 throws
- Double bit 6 lever main lock, 4 throws
- TO ORDER SEPARATELY:
Limiting device chain item 1.06421.10.1/2

	28	85	35	67	3,300	5	1	57787 48 0
	3 art. 1 00122 00 1							

- VERSION WITH SERVICE LOCK AND OPENING LIMITING DEVICE, OPERATED VIA THE INSIDE THUMB TURN ONLY
- Secondary thumb turn lock, 2 throws
- Double bit 6 lever main lock, 4 throws
- TO ORDER SEPARATELY:
Limiting device chain item 1.06421.10.1/2

	28	85	35	67	3,600	1	1	57788 28 0
	28	85	35	67	3,300	5	1	57788 48 0
3 art. 1 00122 00 1								

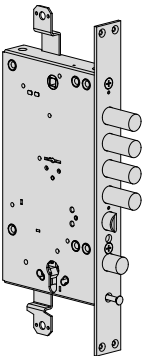

- VERSION WITH SECURITY LOCK (independent locks) the secondary lock can be operated also when the main lock is in its open position
- Secondary cylinder lock, 2 throws
- Double bit 6 lever main lock, 4 throws

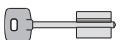





	28	85	35	67	3,600	1	1	B7784 28 0
	38	85	35	67	3,600	1	1	B7784 38 0
	28	85	35	67	3,300	5	1	B7784 48 0
	38	85	35	67	3,300	5	1	B7784 58 0
3 Art. 1 00123 00 1								

- VERSION WITH SECURITY LOCK (interlocked locks) the secondary lock can only be operated when the main lock is in its closed position
- Secondary cylinder lock, 2 throws
- Double bit 6 lever main lock, 4 throws

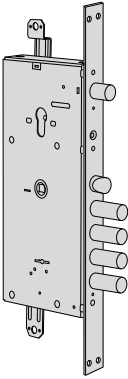
	28	85	35	67	3,600	1	1	B7785 28 0
	38	85	35	67	3,600	1	1	B7785 38 0
	28	85	35	67	3,300	5	1	B7785 48 0
	38	85	35	67	3,300	5	1	B7785 58 0
3 Art. 1 00123 00 1								

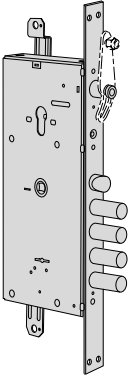
- VERSION WITH SERVICE LOCK
- Secondary cylinder lock, 2 throws
- Double bit 6 lever main lock, 4 throws

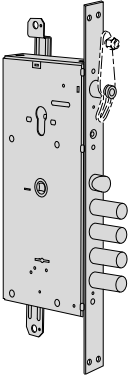
	28	85	35	67	3,600	1	1	B7786 28 0
	38	85	35	67	3,600	1	1	B7786 38 0
	28	85	35	67	3,300	5	1	B7786 48 0
	38	85	35	67	3,300	5	1	B7786 58 0
3 Art. 1 00123 00 1								

Type	Description	Key item	DEADBOLTS							ITEM					
			No.	Projection	Distance	Throws	Centre Distance	Faceplate	Backset	Unit weight	Pieces	Type	Dim.	Hand	Fin.
	<ul style="list-style-type: none"> • VERSION WITH SECURITY LOCK (interlocked locks) the secondary lock can only be operated when the main lock is in its closed position • Secondary cylinder lock, 2 throws • Double bit 6 lever main lock NEW CAMBIO FACILE, 4 throws, with construction key 	 3 art. 1 00162 00 1  1 art. 1 00120 00 1 construction key	28	85	35	67	4,000	1	1	57985	28	A			
	<ul style="list-style-type: none"> • VERSION WITH SERVICE LOCK AND OPENING LIMITING DEVICE, OPERATED VIA THE CYLINDER • Secondary cylinder lock, 2 throws • Double bit 6 lever main lock NEW CAMBIO FACILE, 4 throws with construction key • TO ORDER SEPARATELY: Limiting device chain item 1.06421.10.1/2 	 3 art. 1 00162 00 1  1 art. 1 00120 00 1 construction key	28	85	35	67	4,000	1	1	57987	28	A			
										5	1	57987	48	A	
	<ul style="list-style-type: none"> • VERSION WITH SERVICE LOCK AND OPENING LIMITING DEVICE, OPERATED VIA THE INSIDE THUMB TURN ONLY • Secondary thumb turn lock, 2 throws • Double bit 6 lever main lock NEW CAMBIO FACILE, 4 throws, with construction key • TO ORDER SEPARATELY: Limiting device chain item 1.06421.10.1/2 	 3 art. 1 00162 00 1  1 art. 1 00120 00 1 construction key	28	85	35	67	3,700	5	1	57988	48	A			

Type	Description	Key item	DEADBOLTS								ITEM				
			No.	Projection	Distance	Throws	Centre Distance	Faceplate	Backset	Unit weight Kg	Pieces	Type	Dim.	Hand	Fin.

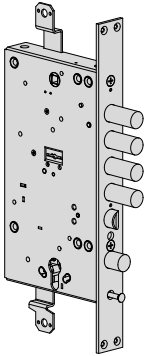

- **VERSION WITH SECURITY LOCK (independent locks)** the secondary lock can be operated also when the main lock is in its open position
- Secondary cylinder lock, 2 throws
- Double bit 6 lever main lock, 4 throws, NEW CAMBIO FACILE, with construction key

	28	85	35	67	4,000	1	1	B7984 28 A
3 art. 1 00164 00	38	85	35	67	4,000	1	1	B7984 38 A
	28	85	35	67	3,700	5	1	B7984 48 A
1 art. 1 00120 00 1 construction key	38	85	35	67	3,700	5	1	B7984 58 A

- **VERSION WITH SECURITY LOCK (interlocked locks)** the secondary lock can only be operated when the main lock is in its closed position
- Secondary cylinder lock, 2 throws
- Double bit 6 lever main lock NEW CAMBIO FACILE, 4 throws, with construction key

	28	85	35	67	4,000	1	1	B7985 28 A
3 art. 1 00164 00	38	85	35	67	4,000	1	1	B7985 38 A
	28	85	35	67	3,700	5	1	B7985 48 A
1 art. 1 00120 00 1 construction key	38	85	35	67	3,700	5	1	B7985 58 A

- **VERSION WITH SERVICE LOCK**
- Secondary cylinder lock, 2 throws
- Double bit 6 lever main lock, NEW CAMBIO FACILE, 4 throws, with construction key

	38	85	35	67	3,800	1	1	B7986 38 A
3 art. 1 00164 00	28	85	35	67	3,700	5	1	B7986 48 A
	38	85	35	67	3,700	5	1	B7986 58 A
1 art. 1 00120 00 1 construction key								



Technical features:

- 11-pin bitting.
- Pins
 - Wear resistant bronze
 - Hardened steel pins in first position.
- Drivers
 - Brass
 - Hardened steel driver in first position
- Phosphor bronze springs
- Hardened steel gate

Operation:

- The key rotation activates/open a window which allows key introduction

Supplied as standard:

- Fixing screws.
- Instruction sheet
- Keys bitted on stem only
- Keys bitted on stem and bits (for New Cambio facile locks)

On request:

- Hardened steel protective rose for double bit key cylinder.

Finishes:

- Standard:
 - polished brass fin. 00
- On request:
 - polished chrome fin. 18

Type	Description	For series/item	L	Kg	Pieces	ITEM			
						Type	Dim.	Hand	Fin.

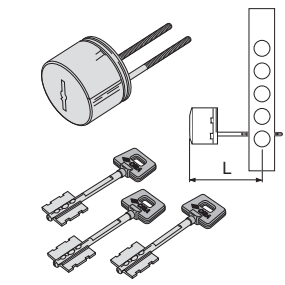

- May be combined with 6 lever double bit key locks, for armoured doors
- Bitted keys only on stem
- For lock combination , bit the key by duplicating main key
- **SUPPLIED AS STANDARD:**
3 keys item 1.00162.00.1

53,0 0,580 1 1 02715 10 1

- May be combined with 6 lever double bit key locks, for armoured doors
- Bitted keys only on stem
- For lock combination , bit the key by duplicating main key
- **SUPPLIED AS STANDARD:**
3 keys item 1.00163.00.1

70,0 0,605 1 1 02715 11 1

Type	Description	For series/item	L	Unit weight Kg	Pieces	ITEM				
						Type	Dim.	Hand	Fin.	Pers.
	<ul style="list-style-type: none"> • May be combined with rekeyable double bit key CAMBIO FACILE locks, for armoured doors • Bitted keys on stem and bit • SUPPLIED AS STANDARD: 3+3 keys item 1.00162.00.1 	53,0	0,350	1	1	02716	00	1		
	<ul style="list-style-type: none"> • May be combined with rekeyable double bit key CAMBIO FACILE locks, for armoured doors • Bitted keys on stem and bit • SUPPLIED AS STANDARD: 5+5 keys item 1.00162.00.1 	53,0	0,840	1	1	02716	01	1		
	<ul style="list-style-type: none"> • May be combined with rekeyable double bit key CAMBIO FACILE locks, for armoured doors • Bitted keys on stem and bit • SUPPLIED AS STANDARD: 3+3 keys item 1.00163.00.1 	70,0	0,350	1	1	02716	10	1		
	<ul style="list-style-type: none"> • May be combined with rekeyable double bit key CAMBIO FACILE locks, for armoured doors • Bitted keys on stem and bit • SUPPLIED AS STANDARD: 5+5 keys item 1.00163.00.1 	70,0	0,400	1	1	02716	11	1		
	<ul style="list-style-type: none"> • May be combined with rekeyable double bit key CAMBIO FACILE locks, for armoured doors • Bitted keys on stem and bit • SUPPLIED AS STANDARD: 3+3 keys item 1.00162.00.1 	53,0	0,665	1	1	02716	50	1		
	<ul style="list-style-type: none"> • May be combined with rekeyable double bit key CAMBIO FACILE locks, for armoured doors • Bitted keys on stem and bit • SUPPLIED AS STANDARD: 5+5 keys item 1.00162.00.1 	53,0	0,820	1	1	02716	51	1		
	<ul style="list-style-type: none"> • May be combined with rekeyable double bit key CAMBIO FACILE locks, for armoured doors • Bitted keys on stem and bit • SUPPLIED AS STANDARD: 3+3 keys item 1.00163.00.1 	70,0	0,350	1	1	02716	60	1		
	<ul style="list-style-type: none"> • May be combined with rekeyable double bit key CAMBIO FACILE locks, for armoured doors • Bitted keys on stem and bit • SUPPLIED AS STANDARD: 5+5 keys item 1.00163.00.1 	70,0	0,833	1	1	02716	61	1		

Type	Description	For series/item	L	Unit weight	Pieces	ITEM				
						Type	Dim.	Hand	Fin.	Pers. Spec.

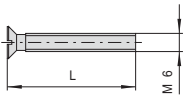

- Nickel-plated steel screws

06460, 06461, 105,0 0,020 25 1 06047 51 0
06480, 06485

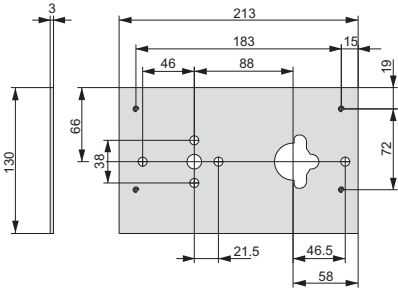

- Steel welding plate
- For double-bit key locks

57000 0,660 12 1 06429 00 0

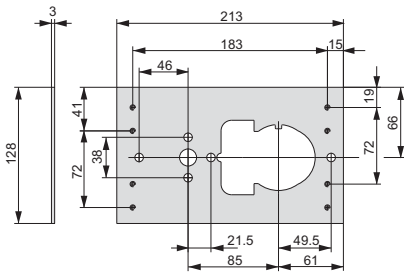

- Steel welding plate
- For cylinder and double-bit key locks

56000, 57000 0,552 12 1 06429 05 0

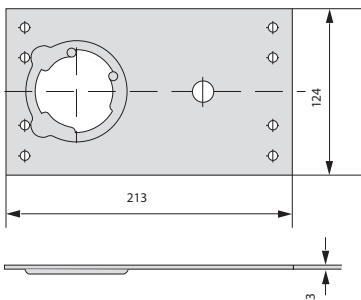

- Steel welding plate for assembly of protection roses series 06485

15000, 56000 0,552 12 1 06429 06 0

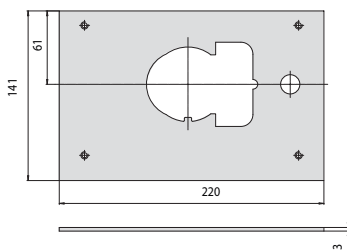

- Steel welding plate
- For cylinder and double-bit key locks

86515, 87515 0,650 12 1 06429 10 0

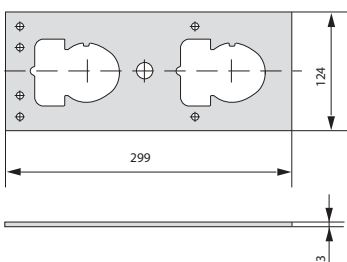

- Steel welding plate
- For double hole locks

56700, 57700, 57900 0,695 12 1 06429 15 0

Type	Description	For series/item	L	Unit weight	Kg	Pieces	ITEM					
							Type	Dim.	Hand	Fin.	Pers.	Spec.
	<ul style="list-style-type: none"> Steel welding plate for assembly of protection roses series 06485 	56765, 56766, 56767, 56768, 56785, 56786, 56787, 56788		0,950		12	1	06429	16	0		
	<ul style="list-style-type: none"> Steel welding plate for assembly of protection roses series 06485 	56715, 56716, 56735, 56736		0,950		12	1	06429	18	0		
	<ul style="list-style-type: none"> Steel welding plate for assembly of protection roses series 06485 	57765, 57766, 57785, 57786, 57787, 57915, 57916, 57917, 57935, 57936, 57937, 57965, 57966, 57967, 57985, 57986, 57987		0,950		12	1	06429	20	0		
	<ul style="list-style-type: none"> Manganese steel anti-drill protection For double bit key locks May be combined with welding plates 	1 06429 05 0, 1 06429 10 0, 1 06429 15 0, 1 06429 18 0, 1 06429 20 0		0,075		12	1	06429	50	0		
	<ul style="list-style-type: none"> Manganese steel anti-drill protection For cylinder key locks May be combined with welding plates 	1 06429 05 0, 1 06429 10 0, 1 06429 15 0, 1 06429 18 0, 1 06429 20 0		0,075		12	1	06429	51	0		

Type	Description	For series/item	L	Unit weight Kg	Pieces	ITEM				
						Type	Dim.	Hand	Fin.	Pers. Spec.
	<ul style="list-style-type: none"> Carbonitrided steel protection rose for bit key cylinder series 02715 and 02716 May be combined with 6 lever and NEW CAMBIO FACILE locks Use assembly plate item 1.06429.05.0 or 1.06429.15.0 SUPPLIED AS STANDARD: Hardened steel hole protection plate Plate ring AVAILABLE FINISHES: Polished brass (fin. 00) Polished chrome (fin. 18) Shotgun grey (fin. 46) satin-finished nickel-plated chrome (fin. B1) 			0,280	1	1	06429	60	1	
	<ul style="list-style-type: none"> Polished brass internal rose to be combined with European profile cylinders on locks series 15000, 56000 AVAILABLE FINISHES: Polished brass (fin. 00) Polished chrome (fin. 18) Anodised light bronze (fin. 65) satin-finished nickel-plated chrome (fin. B1) 			0,036	12	1	06458	10	0	
	<ul style="list-style-type: none"> Polished brass internal rose to be combined with European profile cylinders with adjustable knob on locks series 15000, 56000 AVAILABLE FINISHES: Polished brass (fin. 00) Polished chrome (fin. 18) Anodised light bronze (fin. 65) satin-finished nickel-plated chrome (fin. B1) 	0A317, 0H3S7, 0L3S7, 0M317		0,037	12	1	06458	20	0	
	<ul style="list-style-type: none"> Carbonitrided steel protection rose with polished brass finish 2 screws L. 45 mm. (M6) AVAILABLE FINISHES TO BE DISCONTINUED Anodised light bronze (fin. 65) Polished chrome (fin. 18) 	0A310, 0H3S0, 0L3S1, 0M311, 0Q311	45,0	0,200	1	1	06460	40	0	

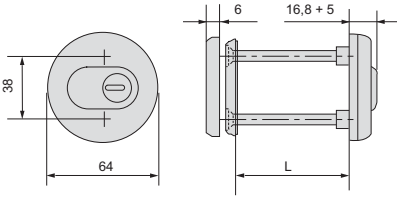
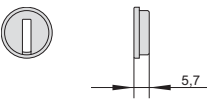
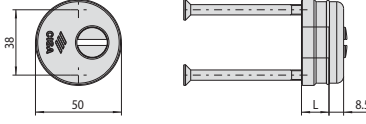
Type	Description	For series/item	L	Unit weight Kg	Pieces	ITEM				
						Type	Dim.	Hand	Fin.	Pers.
	<ul style="list-style-type: none"> • Carbonitrided steel protection rose with polished brass finish • 2 screws (M6) • AVAILABLE FINISHES: Polished brass (fin. 00) Polished chrome (fin. 18) Dark anodised bronze (fin. 64) Anodised light bronze (fin. 65) Satin-finished nickel-plated chrome (fin. B1) 	0A310,0H3S0, 70,0		0,310	1	1	06460	50	0	
		0L3S1,0M311, Q0311								
		0A310,0H3S0, 110,0		0,320	1	1	06460	51	0	
		0L3S1,0M311, Q0311								
		08815	70,0	0,310	1	1	06460	60	0	
		0A317,0H3S7, 70,0		0,335	1	1	06461	50	0	
		0L3S7,0M317, Q0317								
		0A317,0H3S7, 110,0		0,325	1	1	06461	51	0	
		0L3S7,0M317, Q0317								
		08887	70,0	0,200	1	1	06461	60	0	
08887	110,0	0,325	1	1	06461	61	0			
	<ul style="list-style-type: none"> • Carbonitrided steel rotor protection for roses series 06460 and 06461 	0A310,0H3S0, 0L3S1,0M311, Q0311		0,009	50	1	06466	01	0	
	<ul style="list-style-type: none"> • Carbonitrided steel protective rose-casing • 2 L 45 mm screws (M6) • To order separately: -rose cap -cover plate ring • TO BE DISCONTINUED: 106480010, 106480020, 106480100, 106480110, 106480120, 106480200 	0A310,0H3S0, 16,0		0,285	6	1	06480	00	0	
		0L3S1,0M311, Q0311								
		0A310,0H3S0, 24,5		0,385	6	1	06480	01	0	
		0L3S1,0M311, Q0311								
		0A310,0H3S0, 34,5		0,594	6	1	06480	02	0	
		0L3S1,0M311, Q0311								
		0A310,0H3S0, 16,0		0,365	30	1	06480	20	0	
		0L3S1,0M311, Q0311								
		0A310,0H3S0, 24,5		0,482	30	1	06480	21	0	
		0L3S1,0M311, Q0311								
		0A310,0H3S0, 34,5		0,594	30	1	06480	22	0	
		0L3S1,0M311, Q0311								
		08815	16,0	0,365	6	1	06480	10	0	
0A310,0H3S0, 24,5		0,482	6	1	06480	11	0			
0L3S1,0M311, Q0311										
08815	34,5	0,594	6	1	06480	12	0			

Type	Description	For series/item	L	Unit weight	Pieces	ITEM				
						Type	Dim.	Hand	Fin.	Peris. Spec.

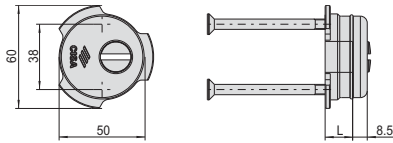

- Carbonitrided steel protective rose-casing with quick coupling
- 2 screws L 45 mm
- **TO BE DISCONTINUED**

0A310,0H350, 16,0	0,378	6	1	06485 00 0
0L351,0M311, 0Q311				
0A310,0H350, 24,5	0,482	6	1	06485 01 0
0L351,0M311, 0Q311				
0A310,0H350, 34,5	0,594	6	1	06485 02 0
0L351,0M311, 0Q311				
0A310,0H350, 16,0	0,378	30	1	06485 20 0
0L351,0M311, 0Q311				
0A310,0H350, 24,5	0,482	30	1	06485 21 0
0L351,0M311, 0Q311				
0A310,0H350, 34,5	0,594	30	1	06485 22 0
0L351,0M311, 0Q311				

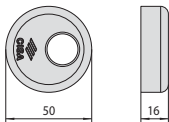

- Protective rose-casing cap
- AVAILABLE FINISHES:
Polished brass (fin. 00)
Polished chrome (fin. 18)
Shotgun grey (fin. 46)
Dark anodised bronze (fin. 64)
Light anodised bronze (fin. 65)
satin-finished nickel-plated chrome (Fin B1)

06480, 06485	16,0	0,025	6	1	06483 00 0
06480, 06485	16,0	0,025	30	1	06483 20 0

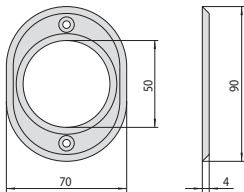

- Cover plate ring for protective rose
- AVAILABLE FINISHES:
Polished brass (fin. 00)
Shotgun grey (fin. 46)
Dark anodised bronze (fin. 64)
- **TO BE DISCONTINUED:**
Polished chrome (fin. 18)
Light anodised bronze (fin. 65)
satin-finished nickel-plated chrome (fin. B1)

06480, 06485		0,025	6	1	06483 60 0
06480, 06485		0,025	30	1	06483 80 0

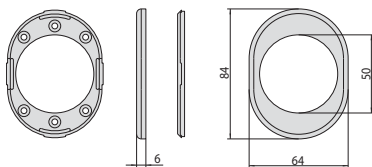

- Cover plate ring for protective rose
- AVAILABLE FINISHES:
Polished brass (fin. 00)
Polished chrome (fin. 18)
Shotgun grey (fin. 46)
Dark anodised bronze (fin. 64)
Light anodised bronze (fin. 65)
satin-finished nickel-plated chrome (fin. B1)

06480, 06485		0,025	30	1	06483 61 0
06480, 06485	16,0	0,025	30	1	06483 81 0

Type	Description	For series/item	L	Unit weight	Kg	Pieces	ITEM					
							Type	Dim.	Hand	Fin.	Pers.	Spec.
	<ul style="list-style-type: none"> Carbonitrided steel rotor, polished chrome, to be combined with roses series 06475, 06476 	0A310,0H3S0, 0L3S1,0M311, 06470,0Q311		0,016		50	1	06472	00	0		
	<ul style="list-style-type: none"> Zinc plated 2 mm. spacer for protection roses 	06480		0,025		25	1	06472	40	0		
	<ul style="list-style-type: none"> Pair of zinc plated anti-crush plates TO BE DISCONTINUED 	06480,06485		0,025		25	1	06472	50	0		
	<ul style="list-style-type: none"> Internal rose AVAILABLE FINISHES: Polished brass (fin. 00) Polished chrome(fin. 18) Anodised dark bronze (fin. 64) Anodised light bronze (fin. 65) satin-finished nickel-plated chrome (fin. B1) 	06460,06461, 06480,06485		0,116		12	1	06473	00	0		
	<ul style="list-style-type: none"> Internal rose for cylinder series 0A317 and 0B317 AVAILABLE FINISHES: Polished brass (fin. 00) Polished chrome(fin. 18) Shotgun grey (fin. 46) Anodised light bronze (fin. 65) Anodised dark bronze (fin. 64) satin-finished nickel-plated chrome (fin. B1) 	06460,06461, 06480,06485		0,120		12	1	06473	10	0		
	<ul style="list-style-type: none"> External ring for plate AVAILABLE FINISHES: Polished brass (fin. 00) Polished chrome(fin. 18) Shotgun grey (fin. 46) Anodised dark bronze (fin. 64) Anodised light bronze (fin. 65) satin-finished nickel-plated chrome (fin. B1) 	1 06429 60 1		0,025		25	1	06473	50	0		
	<ul style="list-style-type: none"> External ring for plate AVAILABLE FINISHES: Polished brass (fin. 00) Shotgun grey (fin. 46) Anodised dark bronze (fin. 64) Anodised light bronze (fin. 65) satin-finished nickel-plated chrome (fin. B1) 	1 06429 60 1		0,025		25	1	06473	51	0		

Type	Description	For series/item	Kg		Pieces		ITEM				
			L	Unit weight			Type	Dim.	Hand	Fin.	Pers.

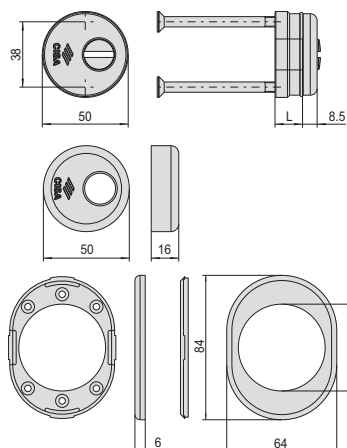

- Carbonitrided steel protective rose
- SUPPLIED AS STANDARD:
Rose body
Cap
Cover plate ring
screws M6 x 45 mm
- AVAILABLE FINISHES:
Polished brass (fin. 00)
Polished chrome-plated (fin. 18)
Anodised dark bronze (fin. 64)
Anodised light bronze (fin. 65)
satin-finished nickel-plated chrome (fin. B1)

16,0	0,365	6	1	06490 00 0
24,5	0,482	6	1	06490 01 0
34,5	0,594	6	1	06490 02 0

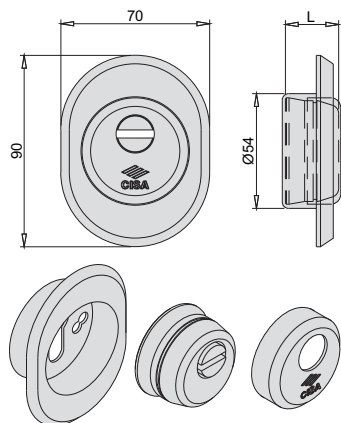

- CONE-SHAPED PROTECTIVE ROSE
- Carbonitrided steel protective rose casing
- 2 screws L. 45 mm. (M6)
- Rose cap
- Inner escutcheon
- AVAILABLE FINISHES:
Polished brass (standard)
Satin nickel-plated chrome (fin. B1)
Polished chrome (fin. 18)

13,0	0,285	1	1	06490 50 0
18,0	0,385	1	1	06490 51 0
22,0	0,594	1	1	06490 52 0
25,0	0,365	1	1	06490 53 0

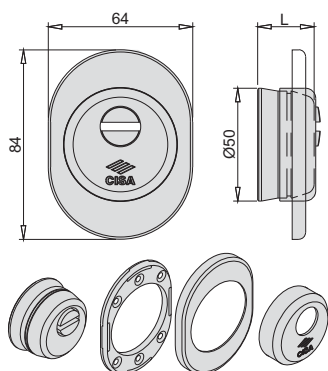

- CONE-SHAPED PROTECTIVE ROSE
- Carbonitrided steel protective rose casing
- 2 screws L. 45 mm.
- Rose cap
- Cover plate ring
- AVAILABLE FINISHES:
Polished brass (standard)
Satin nickel-plated chrome (fin. B1)
Dark anodised bronze (fin. 64)
Polished chrome (fin. 18)
Matt black (fin. 44)
- CONE-SHAPED PROTECTIVE ROSE
- Carbonitrided steel protective rose casing
- 2 screws L. 45 mm. (M8)
- Rose cap
- Cover plate ring
- AVAILABLE FINISHES:
Polished brass (standard)
Satin nickel-plated chrome (fin. B1)
Dark anodised bronze (fin. 64)

18,0	0,378	6	1	06490 18 0
25,0	0,378	6	1	06490 25 0
18,0	0,378	6	1	06498 18 0
25,0	0,378	6	1	06498 25 0

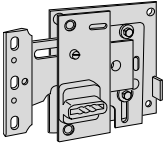
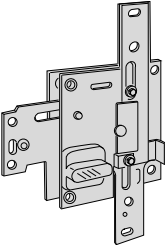
Type	Description	Kg		ITEM		Type	Dim.	Hand	Fin.	Pers.	Spec.
		Unit weight	Pieces	Type	Dim.						
 <ul style="list-style-type: none"> • 2 keys item 1.00100.00.1 • Key removal with open or closed lock • 1 locking point 		0,770	1	1	57410 30 1						
		0,770	1	1	57410 30 2						
		0,400	1	1	57410 35 1						
		0,400	1	1	57410 35 2						
 <ul style="list-style-type: none"> • 2 keys item 1.00100.00.1 • Key removal with open or closed lock • Pre-set for additional locking points 		0,450	1	1	57415 30 1						
		0,930	1	1	57415 35 1						
		0,930	1	1	57415 35 2						



Technical features:

- Electric case operating voltage 12V ac.
- ZAL stainless alloy casing and long lip.
- Satin-finished stainless steel interchangeable faceplates for installation with locks having 28 and 38 mm center distances (to be ordered separately)

Supplied as standard:

- Screws for faceplate fixing

Hand:

0 = Non-handed

1 = R.H. inwards

L.H. outwards

2 = L.H. inwards

R.H. outwards

Cylinder to be ordered separately



Type	Description	Faceplate	Unit weight	Pieces	ITEM			
					Type	Dim.	Hand	Fin.

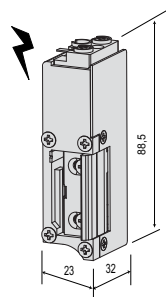

- Electric striker casing
- Voltage 12 V ac CE - current absorption 0,7A
- Hold open catch mechanism
- Hold open device

0,285	12	1	15300	00	1			
0,285	12	1	15300	00	2			

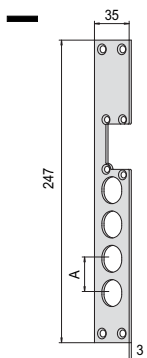

- Satin-finished stainless steel faceplate
- To install with locks with deadbolt distance A=28 mm

34	0,042	12	1	05030	00	0		
----	-------	----	---	-------	----	---	--	--

- Satin-finished stainless steel faceplate
- To install with locks with deadbolt distance A=38 mm

34	0,042	12	1	05031	00	0		
----	-------	----	---	-------	----	---	--	--

Type	Description	For series/item	Unit weight Kg	Pieces	ITEM				
					Type	Dim.	Hand	Fin.	Pers. Spec.
	<ul style="list-style-type: none"> Polished brass internal hole cover For double bit key locks 		0,029	12	1	06081	01	0	
	<ul style="list-style-type: none"> Polished brass key guide For double bit key locks 		0,041	5	1	06123	04	0	
	<ul style="list-style-type: none"> Inside aluminium escutcheon painted in metallic antique bronze colour 		0,036	12	1	06458	11	0	
	<ul style="list-style-type: none"> Nylon key guide supplied with 7 spacers For double bit key locks 		0,050	1	1	06142	01	0	
	<ul style="list-style-type: none"> Key guide with nylon flange supplied with twelve spacers 	1 57500 08 0, 1 57505 08 0, 1 57510 08 0, 1 57515 08 0	0,061	1	1	06142	02	0	
	<ul style="list-style-type: none"> Concealed cable guard with spring 	15000, 17000	0,058	6	1	06515	00	0	
	<ul style="list-style-type: none"> Nylon spacer for key guide series 06144 and 06145 		0,004	100	1	06142	51	0	
	<ul style="list-style-type: none"> Inside escutcheon with spring 		0,325	6	1	06515	15	0	

Type	Description	For series/item	Unit weight Pieces	ITEM			
				Type	Dim.	Hand	Fin.
	<ul style="list-style-type: none"> Polished brass rose with key guide For double bitted locks AVAILABLE FINISHES: Polished chrome (fin.18) Anodised light bronze (fin.65) Anodised dark bronze (fin.64) satin-finished nickel-plated chrome (fin. B1) 		0,105 6	1	06144	10	1
	<ul style="list-style-type: none"> Nylon key guide, including 2 supports for escutcheon and 3 spacers For double bit key locks 		0,066 6	1	06144	15	0
	<ul style="list-style-type: none"> Polished brass cover for escutcheon and key guide AVAILABLE FINISHES: satin-finished nickel-plated chrome (fin. B1) TO BE DISCONTINUED Polished brass (fin.00) Polished chrome (fin.18) Anodised light bronze (fin.65) Anodised dark bronze (fin.64) 	1 06144 10 1, 1 06144 15 0	0,030 50	1	06144	50	1
	<ul style="list-style-type: none"> External cable guard with spring 		0,150 10	1	06515	21	0
	<ul style="list-style-type: none"> Polished brass escutcheon with key guide For double bit key locks AVAILABLE FINISHES: Polished brass (fin.00) Polished chrome (fin.18) Anodised light bronze (fin.65) Anodised dark bronze (fin.64) 		0,135 6	1	06145	10	0
	<ul style="list-style-type: none"> Polished brass escutcheon with key guide For double bit key locks AVAILABLE FINISHES: Polished brass (fin.00) Polished chrome (fin.18) Anodised light bronze (fin.65) Anodised dark bronze (fin.64) 		0,130 6	1	06145	11	0

Type	Description	For series/item	Unit weight Kg	Pieces	ITEM					
					Type	Dim.	Hand	Fin.	Pers.	Spec.
	<ul style="list-style-type: none"> • Key guide escutcheon-nylon key complete with support for escutcheon and 3 spacers • For double bitted locks 		0,135	6	1	06145	15	0		
	<ul style="list-style-type: none"> • Set of brass cover for escutcheon item 1.06145.00.0 • AVAILABLE FINISHES: satin-finished nickel-plated chrome (fin. B1) <p>TO BE DISCONTINUED</p> <p>Anodised light bronze (fin.65) Anodised dark bronze (fin.64)</p>	1 06145 10 0, 1 06145 15 0	0,071	6	1	06145	50	0		
	<ul style="list-style-type: none"> • Zinc plated steel flat striker • For 28 mm. deadbolt locks distance. 		0,132	6	1	06220	00	0		
	<ul style="list-style-type: none"> • Zinc plated steel flat striker • For 28 mm. deadbolt locks distance. 		0,250	6	1	06220	02	0		
	<ul style="list-style-type: none"> • Zinc plated steel flat striker 	1 06433 00 0, 1 06434 00 0, 1 06437 00 0	0,169	6	1	06220	03	0		
	<ul style="list-style-type: none"> • Zinc plated steel flat striker • For double hole locks 		0,220	6	1	06220	05	0		
	<ul style="list-style-type: none"> • Zinc plated steel flat striker • For electric locks 	15510, 15515, 15530, 15535, 17510, 17515, 17530, 17535	0,132	6	1	06220	20	0		
	<ul style="list-style-type: none"> • Zinc plated steel flat striker • For panic function locks with deadbolt distance of 28 mm 	56900	0,250	6	1	06220	26	0		
	<ul style="list-style-type: none"> • Zinc plated steel flat striker • For panic function locks with deadbolt distance of 38 mm 	56900	0,250	6	1	06220	27	0		

Type	Description	For series/item	Unit weight Pieces	ITEM			
				Type	Dim.	Hand	Fin.
	<ul style="list-style-type: none"> • Zinc plated steel flat striker • For 1 deadbolt diverter 	06433	0,169 6	1	06220	28	0
	<ul style="list-style-type: none"> • Zinc plated steel flat striker • For 2 deadbolt diverter 	06433	0,169 6	1	06220	29	0
	<ul style="list-style-type: none"> • Zinc plated steel faceplate • 28 mm. deadbolt distance 	57500	0,297 6	1	06221	00	0
	<ul style="list-style-type: none"> • Zinc plated steel faceplate • 28 mm. deadbolt distance 	56500	0,300 6	1	06221	01	0
	<ul style="list-style-type: none"> • Zinc plated steel faceplate • 28 mm. deadbolt distance 	17500	0,275 6	1	06221	10	0
	<ul style="list-style-type: none"> • Zinc plated steel faceplate • 28 mm. deadbolt distance 	15500	0,295 6	1	06221	11	0
	<ul style="list-style-type: none"> • Zinc plated steel faceplate • 28 mm. deadbolt distance 	1 87515 28 0	0,297 6	1	06221	15	0
	<ul style="list-style-type: none"> • Zinc plated steel faceplate • 28 mm. deadbolt distance 	1 86515 28 0	0,297 6	1	06221	16	0
	<ul style="list-style-type: none"> • Zinc plated steel faceplate • 38 mm. deadbolt distance 	1 86515 38 0	0,297 6	1	06221	17	0
	<ul style="list-style-type: none"> • Zinc plated steel faceplate • 28 mm. deadbolt distance <p>TO BE DISCONTINUED</p>	87665	0,297 6	1	06221	18	0
	<ul style="list-style-type: none"> • Zinc plated steel faceplate • 28 mm. deadbolt distance 	56835, 57815	0,297 6	1	06221	20	0

Type	Description	For series/item	Unit weight Kg	Pieces	ITEM				
					Type	Dim.	Hand	Fin.	Pers. Spec.
	<ul style="list-style-type: none"> Zinc plated steel faceplate 28 mm. deadbolt distance 	57715, 57716, 57735, 57736	0,380	6	1	06221	50	0	
	<ul style="list-style-type: none"> Zinc plated steel faceplate 28 mm. deadbolt distance 	56765, 56766, 56785, 56786	0,380	6	1	06221	51	0	
	<ul style="list-style-type: none"> Zinc plated steel faceplate 28 mm. deadbolt distance 	57915, 57965	0,380	6	1	06221	52	0	
	<ul style="list-style-type: none"> Zinc plated steel faceplate 28 mm. deadbolt distance <p>TO BE DISCONTINUED</p>	B6764, B6765, B6766	0,380	6	1	06221	60	0	
	<ul style="list-style-type: none"> Zinc plated steel faceplate 28 mm. deadbolt distance 	B7964, B7965, B7966	0,380	6	1	06221	62	0	
	<ul style="list-style-type: none"> Nylon slide 	15000, 17000	0,003	6	1	06224	50	0	
	<ul style="list-style-type: none"> Nickel-plated steel cover plate For electric locks with 28 mm. deadbolt distance 		0,023	6	1	06228	08	0	
	<ul style="list-style-type: none"> Nickel-plated steel cover plate For electric locks with 28 mm. deadbolt distance 		0,024	25	1	06228	28	0	
	<ul style="list-style-type: none"> Steel spring rod for floor bolt item 1.06425.00.0 	1 06425 00 0	0,221	12	1	06291	50	0	

Type	Description	For series/item	Unit weight Pieces	ITEM			
				Type	Dim.	Hand	Fin.
	<ul style="list-style-type: none"> • Pair of zinc plated high resistant steel divertor • For mortice locks 		0,128 6	1	06418	01	0
	<ul style="list-style-type: none"> • Pair of zinc plated high resistant steel divertor • For mortice locks 		0,047 6	1	06418	03	0
	<ul style="list-style-type: none"> • Opening limiting device chain • For double hole locks with opening limiting device 		0,066 6	1	06421	10	1
			0,066 6	1	06421	10	2
	<ul style="list-style-type: none"> • Set of zinc plated extension bolts • For rim locks pre-set for additional locking points 		1,500 1	1	06425	02	0
	<ul style="list-style-type: none"> • Set of zinc plated extension bolts • For mortice locks pre-set for additional locking points 		1,435 1	1	06425	03	0

Type	Description	For series/item	Unit weight Pieces	ITEM				
				Type	Dim.	Hand	Fin.	Pers. Spec.
	<ul style="list-style-type: none"> • Set of zinc plated steel connecting bars • For rim locks pre-set for additional locking points 		1,300	1	1	06425	04	0
	<ul style="list-style-type: none"> • Top and bottom extension bolts for use with rekeyable locks (lower spring rod) • For rim locks pre-set for additional locking points 		1,610	1	1	06425	05	0
	<ul style="list-style-type: none"> • Pair of bolts for diverter deadbolt control, galvanized steel • For rim locks pre-set for additional locking points 	56900	0,540	6	1	06425	06	0

Type	Description	For series/item	Unit weight Pieces	ITEM				
				Type	Dim.	Hand	Fin.	Pers.
	<ul style="list-style-type: none"> Zinc plated side bolt (single) S = 3,5 mm. For rim locks pre-set for additional locking points 		0,455	1	1	06433	00	0
	<ul style="list-style-type: none"> Zinc plated side bolt (single) S = 43,5 mm. For rim locks pre-set for additional locking points 		0,510	1	1	06433	10	0
	<ul style="list-style-type: none"> Zinc plated side bolt (double) S = 3,5 mm. For rim locks pre-set for additional locking points 		0,855	1	1	06433	01	0
	<ul style="list-style-type: none"> Zinc plated side bolt (double) S = 43,5 mm. For rim locks pre-set for additional locking points 		0,990	1	1	06433	11	0
	<ul style="list-style-type: none"> Zinc plated side bolt (single) For mortice locks pre-set for additional locking points 		0,646	1	1	06434	00	0
	<ul style="list-style-type: none"> Zinc plated side bolt (double) For mortice locks pre-set for additional locking points 		0,900	1	1	06434	01	0
	<ul style="list-style-type: none"> Zinc plated side bolt (single) For rim locks pre-set for additional locking points 		0,448	1	1	06437	00	0

Type	Description	For series/item	Unit weight Kg	Pieces	ITEM				
					Type	Dim.	Hand	Fin.	Pers. Spec.
	<ul style="list-style-type: none"> • Zinc plated side bolt (double) • For rim locks pre-set for additional locking points 		0,789	1	1	06437	01	0	
	<ul style="list-style-type: none"> • Pair of nylon electric contacts 	15000, 17000	0,029	6	1	06510	10	0	
	<p>TO BE DISCONTINUED</p> <ul style="list-style-type: none"> • Battery (lead) 12V 2.3 ah • For CISA e-Volution locks 		0,492	1	1	06740	00	0	
	<p>TO BE DISCONTINUED</p> <ul style="list-style-type: none"> • 40 VA 12 V AC transformer • For CISA e-Volution locks 		0,492	1	1	07060	01	0	
	<ul style="list-style-type: none"> • Handle and fixed thumb turn to install with Exit lock • AVAILABLE FINISHES: Anodised bronze (fin. 00) satin-finished nickel-plated chrome (fin. B1) 	56915, 56935	0,400	1	1	07070	50	0	
	<ul style="list-style-type: none"> • Pair of handles to install with Exit lock • AVAILABLE FINISHES: Anodised bronze (fin. 00) satin-finished nickel-plated chrome (fin. B1) 	56916, 56917, 56936, 56937	0,400	1	1	07070	60	0	

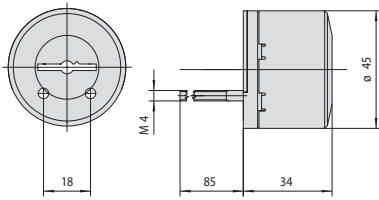

02715, 02716

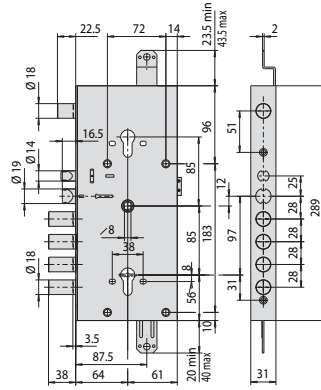

16766, 17766, 17916, 17966

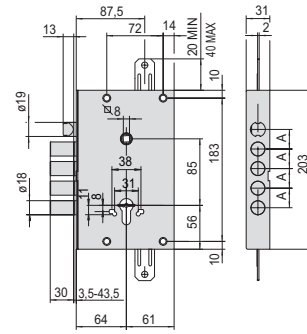

56510, 56515, 56815, 56916, 56917, 57510, 57511, 57512, 57515, 57516, 57517, 57518, 57615, 57665

A = 25 - 27 - 28 - 32 - 37,3

1

4

7

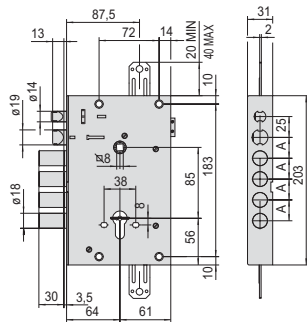

15510, 17510, 15515, 17515, 17615, 17665, E6515, E6615

A = 25 - 27 - 28 - 32 - 37,3

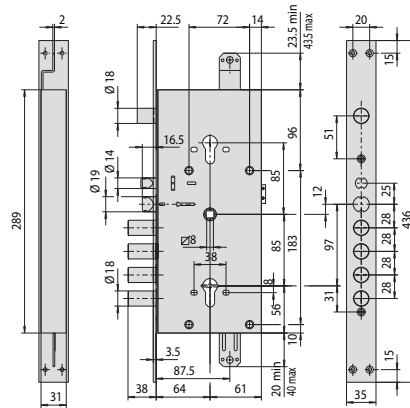

16786, 17786, 17936, 17986

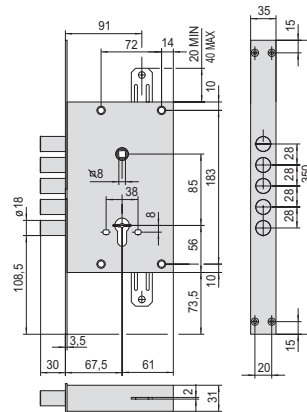

56520, 57520, 57521, 56525, 57525, 57526, 57625, 57675,

2

5

8

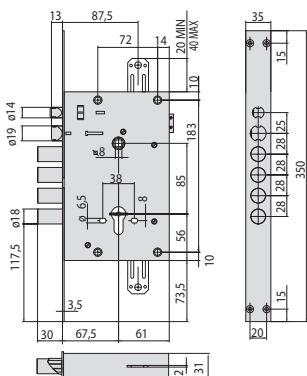

15530, 17530, 15535, 17535, 17635, 17685, E6535

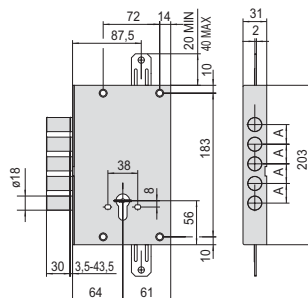

56500, 57500, 57501, 57502, 56505, 57505, 57506, 57507, 57605, 57605, 57655, 67505

A = 25 - 27 - 28 - 32 - 37,3

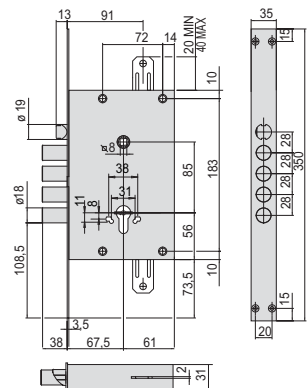

56530, 56535, 56835, 56936, 56937, 57530, 57531, 57535, 57536, 57635, 57685

3

6

9



Fire door locks and panic exit devices



Electronic locks Mito Sensor.....	461
Electronic locks Mito Sensor with panic function	462
Cylinder Mortice Locks	463
Panic function cylinder mortice locks - Mito Panic....	466
Extension bolts for additional locking points.....	470
Cylinder mortice locks - Sicur	471
Panic function cylinder mortice locks - Sicur Panic...	472
Panic function mortice locks with split follower.....	474
Cisa eFAST motorized panic exit devices to combine with mortice locks.....	475
Panic exit devices with black painted case cover for panic function locks	476
Cisa Fast Touch series panic exit devices for panic function mortice locks	477

Cisa Fast Push series panic exit devices for panic function mortice locks	478
Cisa Prestige series panic exit devices for panic function mortice locks	479
Cisa Prestige INOX series panic exit devices for panic function mortice locks	480
Electric handles.....	481
Horizontal bars for panic exit devices.....	482
Accessories for fire door locks.....	483
Dimensional drawings	489

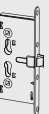



CISA Mito Sensor

**Electronic locks
for fire doors**

The status of the door?

With Mito Sensor it is always known, thanks to the two-colour LED that signals whether access is possible or not.

The new **CISA Mito Sensor** electronic lock provides assisted access for fire doors installed in passageways and emergency exits.



Find out more



Mito Sensor



Technical features:

- Zinc-plated steel case and cover
- Zinc-plated steel 24 mm faceplate
- Zinc-plated steel latchbolt
- 9 mm square spindle
- Non-handed to match the door hand by means of a microswitch setting
- Mechanical hold open
- For installation on single or double-leaf doors
- 12V and 24V AC/DC power supply voltage
- Variable lock opening time from 3 to 30 s, adjustable by trimmer
- Pre-set for connection to door status LED

Supplied as standard:

- Cylinder fixing screws
- 1.5 m power supply cable

On request:

- Power supply item 107302080
- Handle plates series 07070-22-24-25-26
- Striker item 107073200
- Square spindle series 07083-50/53-70
- LED item 107126100

Certifications:

- CE marking in compliance with Construction Products Regulation No. 305/2011

Hand:
0 = Non-handed

Cylinder to be ordered separately



Type	Description	Centre Distance	Faceplate	Backset	Unit weight Kg	Pieces	ITEM			
							Type	Dim. Hand	Fin.	Pers. Spec.

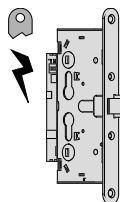

ELECTRONIC "FAIL SECURE" LOCK

- Latchbolt only
- Zinc-plated steel faceplate

72 24 65 0,980 1 1 13105 65 0

OPERATION:

- from inside: with handle activated electrically/mechanically or with key (if fitted)
- from outside: the key enables/disables the handle and with draws the latchbolt. The coil, normally unpowered, will maintain the handle disabled.
- The electric impulse activates the handle when the "false throw" is enabled.

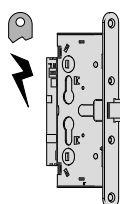

ELECTRONIC "FAIL SAFE" LOCK

- Latchbolt only
- Zinc-plated steel faceplate

72 24 65 0,980 1 1 13205 65 0

OPERATION:

- from inside: with handle activated electrically/mechanically or with key (if fitted)
- from outside: the key enables/disables the handle and withdraws the latchbolt.
- The coil, normally powered, will maintain the handle disabled.
- The electric impulse activates the handle when the "false throw" is enabled.



Technical features:

- Zinc-plated steel case and cover
- Zinc-plated steel 24 mm faceplate
- Zinc-plated steel latchbolt
- 9 mm square spindle
- Non-handed to match the door hand by means of a microswitch setting
- Mechanical hold open
- For installation on single or double-leaf doors
- 12V and 24V AC/DC power supply voltage
- Variable lock opening time from 3 to 30 s, adjustable by trimmer
- Pre-set for connection to door status LED

Supplied as standard:

- Cylinder fixing screws
- 1.5 m power supply cable

On request:

- Power supply item 107302080
- Handle plates series 07070-22-24-25-26
- Panic exit devices from the 59600 and 59700 series,
- Striker item 107073200
- Square spindle series 07083-50/53-70
- LED item 107126100

Standards:

- CE marking in compliance with Construction Products Regulation No. 305/2011

Hand:
0 = Non-handed

Cylinder to be ordered separately



Mito Sensor Panic

Type	Description	Centre Distance	Faceplate	Backset	Kg	Pieces	ITEM			
							Type	Dim.	Hand	Fin.

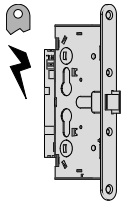

ELECTRONIC "FAIL SECURE" LOCK

- Latchbolt only
- Zinc-plated steel faceplate

72 24 65 0,980 1 1 13115 65 0

OPERATION:

- from inside: with handle/panic exit device and with key (if fitted)
- from outside: the key enables/disables the handle and withdraws the latchbolt.

The coil, normally unpowered, will maintain the handle disabled. The electric impulse activates the handle when the "false throw" is enabled.

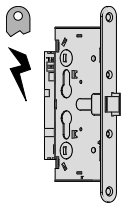

ELECTRONIC "FAIL SAFE" LOCK

- Latchbolt only
- Zinc-plated steel faceplate

72 24 65 0,980 1 1 13215 65 0

OPERATION:

- from inside: with handle/panic exit device and with key (if fitted)
- from outside: the key enables/disables the handle and withdraws the latchbolt.

The coil, normally powered, will maintain the handle disabled. The electric impulse activates the handle when the "false throw" is enabled.



Technical features:

- Zinc-plated steel faceplate
- Zinc-plated steel case
- Zinc-plated steel latch
- 9 mm. through follower

On request:

- Stainless steel faceplate fin. 20

Standards:

- CE marking in accordance with the regulation 305/2011

Hand:

0 = Non-handed

Cylinder to be ordered separately



Mito

Type	Description	Throws	Centre Distance	Faceplate	Backset	Unit weight 	Pieces 	ITEM			
								Type	Dim.	Hand	Fin.

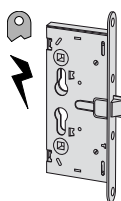

ELECTRIC LOCK

- Latch only
- OPERATION:**
- From inside: by handle or key
 - From outside: by electrically operated handle and/or key

72 24 65 0,980 1 1 13100 65 0

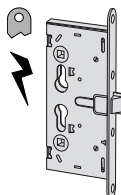

"FAIL SAFE" FUNCTION ELECTRIC LOCK

- Latch only
- OPERATION:**
- From inside: by handle
 - From outside: the key activates or deactivates the handle and withdraws the latchbolt. The live coil keeps the handle disabled and only enables it if power supply is off.

72 24 65 0,980 1 1 13200 65 0

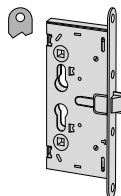

MECHANICAL LOCK

- Latch only
- OPERATION:**
- Latch can be operated by key or handle

72 24 65 0,690 12 1 43000 65 0

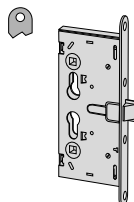

MECHANICAL LOCK

- Latch only
 - Pre-set for additional locking points
- OPERATION:**
- The handle withdraws the latchbolt only when enabled by the key. When the handle is disabled, it cannot operate the latchbolt
 - The key withdraws the latchbolt

1 72 24 65 0,850 24 1 43014 65 0

Type	Description	Throws	Centre Distance	Faceplate	Backset	Unit weight Kg	Pieces	ITEM			
								Type	Dim.	Hand	Fin.

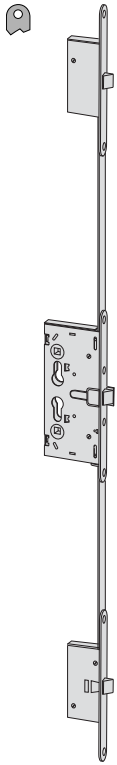

MECHANICAL LOCK

- Latchbolt and deadbolt
- Pre-set for additional locking points

OPERATION:

- The handle withdraws the latchbolt only when enabled by the key. When the handle is disabled, it cannot operate the latchbolt
- The key withdraws the latchbolt

72	24	65	1,750	6	1 43015 65 0
----	----	----	-------	---	--------------

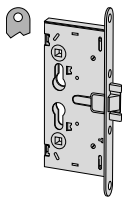

MECHANICAL LOCK

- Deadbolt and latchbolt
- 1 15-mm throw.
- Stainless steel faceplate fin. 20

OPERATION:

- Latch can be operated by key or handle
- Deadbolt can be operated by key

1	72	24	65	0,746	12	1 43020 65 0
---	----	----	----	-------	----	--------------

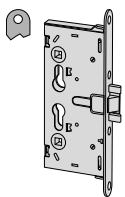

MECHANICAL LOCK

- Deadbolt and latchbolt
- 1 15-mm throw.
- Pre-set for additional locking points

OPERATION:

- Latch can be operated by key or handle
- Deadbolt can be operated by key

ON REQUEST:

- Set of side latches item 1.07090.50.0
- Set of bolt extension rods item 1.07091.50.0

1	72	24	65	0,850	12	1 43024 65 0
---	----	----	----	-------	----	--------------

Type	Description	Throws	Centre Distance	Faceplate	Backset	Unit weight 	Pieces 	ITEM			
								Type	Dim.	Hand	Fin.

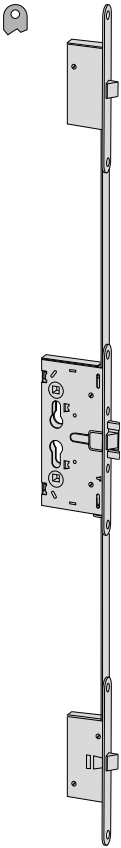

MECHANICAL LOCK

- Deadbolt and latchbolt
- 15-mm throw.
- 3 locking points

OPERATION:

- Latch can be operated by key or handle
- Deadbolt can be operated with the key

1	72	24	65	1,400	6	1	43025 65 0
---	----	----	----	-------	---	---	------------

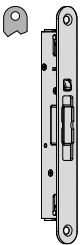

• FOR SECONDARY LEAF OF DOUBLE DOORS

OPERATION:

- Extension bolts are operated by a lever on the faceplate
- Rods forward strike 17 mm

ON REQUEST:

- Extension bolts item 1.07088.03.0
- Automatic dogging device item 1.07089.50.0

1	24			0,360	3	1	43091 00 0
---	----	--	--	-------	---	---	------------

Technical features:

- Zinc-plated steel faceplate
- Zinc-plated steel case
- Zinc-plated steel latch
- 9 mm. split follower
- Can be combined with the panic exit devices series 59600 and 59711

On request:

- Stainless steel faceplate fin. 20

Standards:

- CE marking in accordance with the regulation 305/2011

Hand:
0 = Non-handed

Cylinder to be ordered separately

Mito Panic

Type	Description	Throws	Centre Distance	Faceplate	Backset	Unit weight	Pieces	ITEM				
								Type	Dim.	Hand	Fin.	Pers. Spec.

ELECTRIC LOCK

- Latch only

OPERATION:

- From inside: by handle or panic exit device (panic function)
- From outside: by electrically operated handle and/or key

72	24	65	0,980	1	1	13110 65 0
----	----	----	-------	---	---	------------

ELECTRIC LOCK

- Latch only

OPERATION:

- For inward opening panic doors

72	24	65	0,980	1	1	13160 65 1
72	24	65	0,980	1	1	13160 65 2

"FAIL SAFE" FUNCTION ELECTRIC LOCK

- Latch only

OPERATION:

- From inside: by handle or panic exit device (panic function)
- From outside: the key activates or deactivates the handle and withdraws the latchbolt. The live coil keeps the handle disabled and only enables it if power supply is off.

72	24	65	0,980	1	1	13210 65 0
----	----	----	-------	---	---	------------

"FAIL SAFE" FUNCTION ELECTRIC LOCKS

- Latch only

OPERATION:

- For inward opening panic doors
- From outside: the key activates or deactivates the handle and withdraws the latchbolt. The live coil keeps the handle disabled and only enables it if power supply is off.

72	24	65	0,980	1	1	13260 65 1
72	24	65	0,980	1	1	13260 65 2

Type	Description	Throws	Centre Distance	Faceplate	Backset	Unit weight 	Pieces 	ITEM			
								Type	Dim. Hand	Fin.	Pers. Spec.
	<p>MECHANICAL LOCK</p> <ul style="list-style-type: none"> Latch only Stainless steel faceplate fin. 20 <p>OPERATION:</p> <ul style="list-style-type: none"> From inside: by panic exit device and/or key From outside: the key activates and deactivates the handle and withdraws the latchbolt; the handle withdraws the latchbolt only if it is enabled by the key 	72	24	65	0,848	6	1	43110	65	0	
	<p>Technical features: To combined with motorized panic exit devices eFAST series 59751</p> <ul style="list-style-type: none"> Latch only Stainless steel faceplate fin. 20 <p>OPERATION:</p> <ul style="list-style-type: none"> Inside: with panic exit device and/or key Outside: the key activates and deactivates the handle and withdraws the latchbolt; the handle withdraws the latchbolt only if it is enabled by the key 	72	24	65	0,848	6	1	43112	65	0	
	<p>MECHANICAL LOCK</p> <ul style="list-style-type: none"> Latch only Pre-set for additional locking points <p>ON REQUEST:</p> <ul style="list-style-type: none"> Zinc-plated steel extension bolts item 1.07091.50.0 Set of zinc-plated steel side latchbolts item 1.07090.50.0 <p>OPERATION:</p> <ul style="list-style-type: none"> From inside: by panic exit device and/or key From outside: the key activates and deactivates the handle and withdraws the latchbolt; the handle withdraws the latchbolt only if it is enabled by the key 	72	24	65	0,850	6	1	43114	65	0	

Type	Description	Throws	Centre Distance	Faceplate	Backset	Unit weight Kg	Pieces	ITEM			
								Type	Dim.	Hand	Fin.

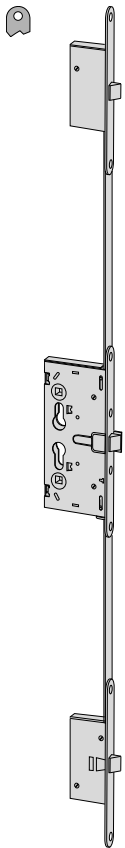

MECHANICAL LOCK

- Latches only
 - 3 locking points
- OPERATION:**
- From inside: by panic exit device and/or key
 - From outside: the key activates and deactivates the handle and withdraws the latchbolts
 - The handle withdraws the latchbolts only if it is enabled by the key.

72	24	65	1,750	6	1	43115	65	0
----	----	----	-------	---	---	-------	----	---

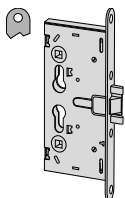

MECHANICAL LOCK

- Deadbolt and latchbolt
 - 1 15-mm throw.
- OPERATION:**
- From inside: by panic exit device and/or key
 - From outside: the key withdraws the latchbolt and the deadbolt

1	72	24	65	0,853	6	1	43120	65	0
---	----	----	----	-------	---	---	-------	----	---

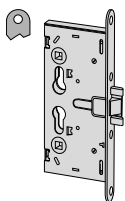

MECHANICAL LOCK

- Deadbolt and latchbolt
 - 1 15-mm throw.
- OPERATION:**
- From inside: by panic exit device and/or key
 - From outside: the key withdraws the latchbolt and the deadbolt, the handle withdraws the latchbolt

1	72	24	65	0,876	6	1	43130	65	0
---	----	----	----	-------	---	---	-------	----	---

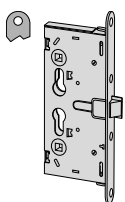

MECHANICAL LOCK

- Latch only
 - Stainless steel faceplate fin. 20
- OPERATION:**
- For inward opening panic doors

72	24	65	0,750	6	1	43160	65	1
72	24	65	0,845	6	1	43160	65	2

Type	Description	Throws	Centre Distance	Faceplate	Backset	Unit weight 	Pieces 	ITEM			
								Type	Dim.	Hand	Fin.

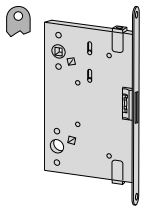

FOR SECONDARY LEAF OF DOUBLE DOORS

- Latch only lock item 1.43110.65.0 or 1.43115.65.0 installed on main leaf

- Rod forward stroke 17 mm

OPERATION:

- From inside: panic exit device

ON REQUEST:

- Extension bolts item 1.07088.03.0
- Automatic dogging device item 1.07089.50.

1	24	65	0,858	1	1	43190 65 0
1	24	95	1,150	1	1	43190 95 0

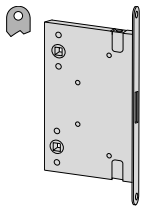

FOR SECONDARY LEAF OF DOUBLE DOORS

- Latch only lock item 1.43110.65.0 or 1.43115.65.0 installed on main leaf

- Rod forward stroke 17 mm
- Double follower for non-handed doors

OPERATION:

- From inside: panic exit device

ON REQUEST:

- Inside bolt extension rods with screw item 1.07088.03.0
- Automatic dogging device item 1.07089.50.0

1	24	65	0,858	1	1	43191 65 0
1	24	95	1,000	1	1	43191 95 0

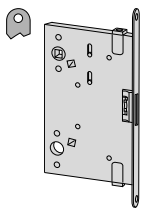

• COUNTER LOCK FOR SECONDARY LEAF OF DOUBLE DOOR

- To combined with motorized panic exit devices eFAST series 59751
- Latch only lock item 1.43112.65.0 installed on main leaf
- Rod forward stroke 17 mm

OPERATION:

- From inside: with panic exit device

ON REQUEST:

- Extension bolts item 1.07088.03.0
- Automatic dogging device item 1.07089.50.0

1	24	65	0,858	1	1	43192 65 0
---	----	----	-------	---	---	-------------------

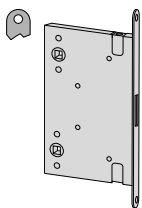

• NON-HANDED COUNTER LOCK FOR SECONDARY LEAF OF DOUBLE DOOR

- To combined with motorized panic exit devices eFAST series 59751
- Latch only lock item 1.43112.65.0 installed on main leaf
- Rod forward stroke 17 mm

OPERATION:

- From inside: with panic exit device

ON REQUEST:

- Extension bolts item 1.07088.03.0
- Automatic dogging device item 1.07089.50.0

1	24	65	0,858	1	1	43193 65 0
---	----	----	-------	---	---	-------------------

Type	Description	For series/item	 Unit weight	 Pieces	ITEM				
					Type	Dim.	Hand	Fin.	Pers. Spec.

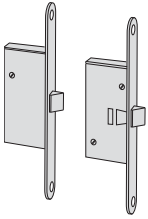

• Set of zinc plated side latches

43024, 43114 0,900 24 1 07090 50 0

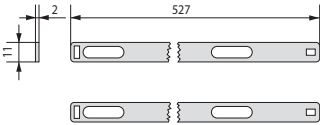

• Set of zinc plated rods

1 07090 50 0 0,230 24 1 07091 50 0



Technical features:

- Zinc-plated steel faceplate
- Zinc-plated steel case
- Nickel-plated reversible steel latch with anti-picking device
- Single throw (15 mm.) nickel-plated deadbolt
- 9 mm. through follower

Hand:

0 = Non-handed

Cylinder to be ordered separately



Supplied as standard:

- Instruction sheet

Standards:

- CE marking in accordance with the regulation 305/2011

Sicur

Type	Description	Throws	Centre Distance	Faceplate	Backset	Unit weight	Pieces	ITEM			
								Type	Dim. Hand	Fin.	Pers. Spec.

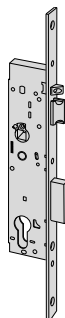

- Deadbolt and latch
- OPERATION:
Outside and inside: latch and deadbolt operated by key; latch withdrawn by handle

1	92	24	25	0,680	1	1	43520	25	0		
1	92	24	30	0,720	1	1	43520	30	0		
1	92	24	35	0,762	1	1	43520	35	0		
1	92	24	40	0,805	1	1	43520	40	0		
1	92	24	45	1,000	1	1	43520	45	0		

- Deadbolt and latch
- OPERATION:
Outside and inside: the key operates the deadbolt and activates or disactivates the handle for latch operation

1	92	24	35	0,775	1	1	43530	35	0		
1	92	24	40	0,805	1	1	43530	40	0		



Technical features:

- Zinc-plated steel faceplate
- Zinc-plated steel case
- Nickel-plated reversible steel latch
- Single throw (15 mm.) nickel-plated deadbolt
- 9 mm. split follower
- Can be combined with the panic exit devices series 59600 and 59711.10/11.0.00.00.FE

Hand:

0 = Non-handed

Cylinder to be ordered separately



Supplied as standard:

- Instruction sheet

Standards:

- CE marking in accordance with the regulation 305/2011

Sicur Panic

Type	Description	Throws	Centre Distance	Faceplate	Backset	Unit weight Kg	Pieces	ITEM			
								Type	Dim.	Hand	Fin.

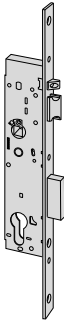

- FOR SINGLE LEAF DOORS
- Dead-locking latch and deadbolt
- A TYPE OPERATION
- Inside:
 - Panic exit device for opening
 - Key for closing with deadbolt
- Outside:
 - Key for activating latch and deadbolt

1	92	24	25	0,610	1	1	43620 25 0
1	92	24	30	0,655	1	1	43620 30 0
1	92	24	35	0,800	1	1	43620 35 0
1	92	24	40	0,730	1	1	43620 40 0
1	92	24	45	0,780	1	1	43620 45 0

- B TYPE OPERATION
- Inside:
 - Panic exit device for opening
 - Key for closing with deadbolt and activating or disactivating external handle for latch operation
- Outside:
 - Key for closing with deadbolt and activating or disactivating external handle for latch operation

1	92	24	25	0,610	1	1	43630 25 0
1	92	24	30	0,655	1	1	43630 30 0
1	92	24	35	0,690	1	1	43630 35 0
1	92	24	40	0,730	1	1	43630 40 0
1	92	24	45	0,780	1	1	43630 45 0

Type	Description	Throws	Centre Distance	Faceplate	Backset	Unit weight 	Pieces 	ITEM				
								Type	Dim.	Hand	Fin.	Pers. Spec.

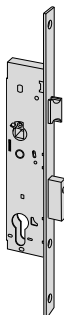

- FOR DOUBLE DOORS
- Panic lock series 43690 to be installed on secondary leaf
- deadbolt and latch
- A TYPE OPERATION
- Inside:
 - Panic exit device for opening
 - Key for closing with deadbolt
- Outside:
 - Key for activating latch and deadbolt

1	92	24	25	0,560	1	1	43650 25 0
1	92	24	30	0,610	1	1	43650 30 0
1	92	24	35	0,725	1	1	43650 35 0
1	92	24	40	0,770	1	1	43650 40 0
1	92	24	45	0,710	1	1	43650 45 0

- B TYPE OPERATION
- Inside:
 - Panic exit device for opening
 - Key for closing with deadbolt and activating or disactivating external handle for latch operation
- Outside:
 - Key for closing with deadbolt and activating or disactivating external handle for latch operation

1	92	24	25	0,640	1	1	43660 25 0
1	92	24	30	0,610	1	1	43660 30 0
1	92	24	35	0,725	1	1	43660 35 0
1	92	24	40	0,760	1	1	43660 40 0
1	92	24	45	0,710	1	1	43660 45 0

- C TYPE OPERATION
- Replacing series 43631
- Inside:
 - Panic exit device for opening
 - Key for closing with deadbolt and activating external handle for latch operation
- Outside:
 - Key for closing with deadbolt and activating external handle for latch operation

1	92	24	25	0,560	1	1	43661 25 0
1	92	24	30	0,610	1	1	43661 30 0
1	92	24	35	0,640	1	1	43661 35 0
1	92	24	40	0,670	1	1	43661 40 0
1	92	24	45	0,710	1	1	43661 45 0

- D TYPE OPERATION
- Replacing series 43632
- Inside:
 - Panic exit device for opening
 - Key for closing with deadbolt
- Outside:
 - Key for closing with deadbolt. The handle, with deadbolt withdrawn, is activated for latch operation

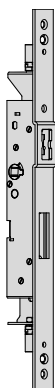

1	92	24	25	0,560	1	1	43662 25 0
1	92	24	30	0,610	1	1	43662 30 0
1	92	24	35	0,715	1	1	43662 35 0
1	92	24	40	0,760	1	1	43662 40 0
1	92	24	45	0,710	1	1	43662 45 0

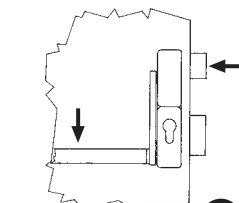
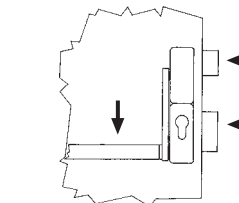
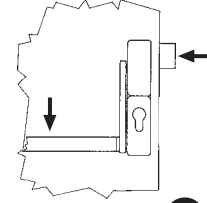
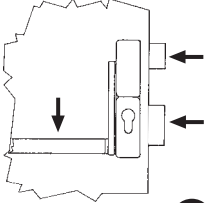
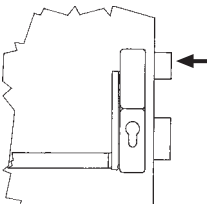
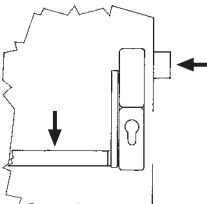
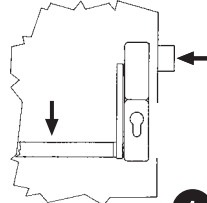
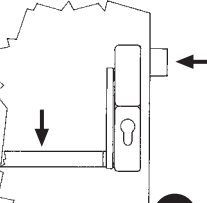

- FOR SECONDARY LEAF OF A DOUBLE DOOR
- Panic lock series 43650, 43660, 43661, 43662 to be installed on secondary leaf
- OPERATION:
- Inside:panic exit device
- ON REQUEST:
 - extension bolts item 1.07088.03.0
 - Automatic dogging device item 1.07089.50.0
 - Top striker item 1.06141.80.0

28	30	0,795	1	1	43690 30 0
28	40	0,865	1	1	43690 40 0
28	60	1,020	1	1	43690 60 0
28	75	1,100	1	1	43690 75 0

TYPE	CONTROLS	OPERATION	
<p>A</p> <p>OUTSIDE ENTRANCE BY KEY</p> <p>For doors which have to be opened with the key from the outside by authorised personnel only</p>	<p>INSIDE</p> <ul style="list-style-type: none"> - Panic exit device to open. - Key to close with deadbolt. <p>OUTSIDE</p> <ul style="list-style-type: none"> - The key operates latch and deadbolt. 	 <p>1 Outside entrance by key only.</p>	 <p>2</p> <p>Locking with the deadbolt, outside entrance is possible only with the use of the key.</p>
<p>B</p> <p>OUTSIDE HANDLE ACTIVATED OR DISACTIVATED</p> <p>For doors that open outwards and places where it is necessary to provide free entrance.</p>	<p>INSIDE</p> <ul style="list-style-type: none"> - Panic exit device to open. - Key to close with deadbolt and activate or deactivate the outside handle. <p>OUTSIDE</p> <ul style="list-style-type: none"> - The key operates the deadbolt and activates or deactivates the outside handle for latch operation. 	 <p>1</p> <p>The outside handle is activated by rotating the key in the lock-opening direction as far as it will go (the handle remains activated when the key is removed).</p>	 <p>2</p> <p>Closing with the deadbolt deactivates the outside handle; the latter remains deactivated even after the door has been opened with the panic exit device.</p>
<p>C</p> <p>OUTSIDE HANDLE AUTOMATICALLY DISACTIVATED</p> <p>For doors that must be opened from the outside only by authorised persons.</p>	<p>INSIDE</p> <ul style="list-style-type: none"> - Panic exit device to open. - Key to close with deadbolt. <p>OUTSIDE</p> <ul style="list-style-type: none"> - The key operates the throw and activates the handle. 	 <p>1</p> <p>The outside handle is activated by rotating the key in the lock-opening direction as far as it will go, after first withdrawing the deadbolt.</p>	 <p>2</p> <p>Removing the key automatically deactivates the outside handle.</p>
<p>D</p> <p>OUTSIDE HANDLE ALWAYS ACTIVATED</p> <p>For doors that partition throughways (e.g. corridors).</p>	<p>INSIDE</p> <ul style="list-style-type: none"> - Panic exit device to open. - Key to close with deadbolt. <p>OUTSIDE</p> <ul style="list-style-type: none"> - The key operates the deadbolt. The handle, with the deadbolt withdrawn, engages for latch operation. 	 <p>1</p> <p>The outside handle is always activated when the deadbolt is withdrawn.</p>	 <p>2</p> <p>Entry is after using the panic exit device, always possible from the outside as long as the deadbolt is not activated by the key.</p>

Technical features:

- Painted aluminum alloy/aluminum cover
- Panic exit device can be shortened up to 600 mm
- Mortice panic exit device for installation with a lock and counter lock on single and double leaf doors
- Non-handed
- Can be integrated into an existing access control system
- Can also be controlled by a button
- Voltage 12V DC
- Opening sound signal
- Max. current absorption 1.5A
- Operating temperature from -10 to +55°C
- Timed latch withdrawal after opening, adjustable from 3 to 180 seconds by purchasing the programming cable

Operation:

- The motor inside the bar activates the panic exit device connected to the lock and withdraws the latchbolt.
- When installed on double doors, the panic exit device motor on the secondary leaf withdraws the tips of the

top/bottom locking points connected to the counter lock.

Supplied as standard:

- Power supply cable length 4 m supplied as standard

On request:

- Internal and external plates

Finishes:

- STANDARD: Black cover, red bar
- ON REQUEST: Grey cover, grey bar (fin. 97). PVD satin-finished stainless steel treatment (fin. C2)

Standards:

- CE marking in accordance with the regulation n° 305/2011 granted by ICIM

Type	Description	Spindle hole	L	Unit weight	Pieces	ITEM			
						Type	Dim.	Hand	Fin.

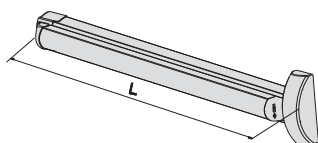

- **MOTORIZED PANIC EXIT DEVICE**
To be combined with locks art. 1.43112.65.0 and art. 1.43192.65.0, 1.43193.65.0 for installation on double leaf doors

8/9	1200	4,000	1	1	59751	00	0	00	00	FR
8/9	840	3,500	1	1	59751	01	0	00	00	FR

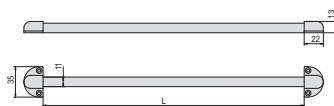

- **Outside escutcheon with spring**

	300	0,100	10	1	06515	20	0			
	600	0,150	10	1	06515	21	0			

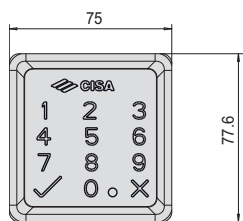

- Keypad
- Glossy black
- satin-finished nickel-plated chrome (fin. B1)

	0,500		1	1	06525	77	0			
	0,500		1	1	06525	77	0	B1		



Technical features:

- Black painted aluminium casings or black nylon
- Internal, zinc-plated steel components, suitable for fire doors

Supplied as standard:

- Fixing screws
- Instruction sheet for assembly and maintenance
- CE and ICIM certification

Finish:

- ON REQUEST: 59615-59646 series
Painted gray (fin. 97)

Standards:

- CE marking in accordance with the regulation n° 305/2011

Hand:

0 = Non-handed

Bar to be ordered separately



series 07007

Type	Description	Spindle hole	Centre Distance	Unit weight Kg	Pieces	ITEM				
						Type	Dim.	Hand	Fin. Pers. Spec.	
	<ul style="list-style-type: none"> • Black nylon casing • May be combined with mortice locks series 43100, 43600 • pre-set for single cylinder 	9	72	1,400	1	1	59616	00	0	
	<ul style="list-style-type: none"> • Black nylon casing • May be combined with mortice locks series 43100 • pre-set for double cylinder 	9	72	1,350	1	1	59616	10	0	
	<ul style="list-style-type: none"> • Black nylon cover • FOR THE SECONDARY LEAF OF A DOUBLE DOOR, where it is not possible to assemble the safety lock • On the main door it is possible to install the panic exit devices series 59616 together with the locks series 43110 and 43114 • SUPPLIED AS STANDARD: Striker item 1.07072.11.0 Floor striker item 1.07003.11.0 • TO BE ORDERED SEPARATELY Pair of extension bolts item 1.07081.12.0 	-	-	2,050	1	1	59647	00	0	



Technical features:

- Painted aluminium body and bar
- Painted aluminum alloy cover
- Adjustable length up to 300 mm
- Galvanized steel internal components suitable for fire doors

Supplied as standard:

- Fixing screws
- ICIM and CE certificates of compliance
- Installation and maintenance Instructions

On request:

- Internal and external plates
- Version with microswitch (spec. LA)

Standards:

- Cover: black bar: red ON REQUEST (only item 1.59711-00/10-0):
- Cover: black bar: black (fin. 44)
- Cover: white bar: white (fin. 45)
- Cover: gray bar: gray (fin. 97)
- Carter and bar painted steel grey (fin. B9)
- PVD treatment: satin-finished stainless steel (fin. C2)

Standards:

- CE marking in accordance with the regulation n° 305/2011

Hand:

0 = Non-handed

FAST Touch

Type	Description	Spindle hole	L	Unit weight	Pieces	ITEM			
						Type	Dim. Hand	Fin.	Pers. Spec.

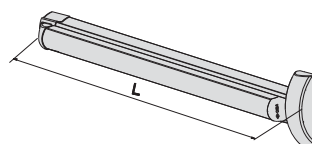

- Can be combined with panic function locks series Sikurexit, Heavy Duty and 52810, 52830 and 43100

8/9	1200	3,366	1	1 59711 00 0 00 00 FR
8/9	840	2,592	1	1 59711 01 0 00 00 FR
8/9	1300	3,750	1	1 59711 06 0 00 00 FR

- Satin-finished PVD-treated stainless steel

8/9	1200	3,366	1	1 59711 00 0 C2 00 FR
8/9	1300	3,750	1	1 59711 06 0 C2 00 FR

- Can be combined with panic function locks series Exitlock and Sicur Panic

8/9	1200	3,360	1	1 59711 10 0 00 0 FR
8/9	840	2,592	1	1 59711 11 0 00 0 FR
8/9	1300	3,750	1	1 59711 16 0 00 0 FR

- Satin-finished PVD-treated stainless steel

8/9	1200	3,366	1	1 59711 10 0 C2 00 FR
8/9	1300	3,750	1	1 59711 16 0 C2 00 FR

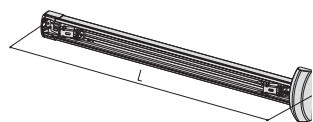

- SUPPLIED WITHOUT PUSH BAR VERSION
- Can be combined with panic function locks series Sikurexit, Heavy Duty and 52810, 52830 and 43100

8/9	1200	2,366	1	1 59711 00 0 00 SB FR
8/9	1300	2,566	1	1 59711 06 0 00 SB FR

- Can be combined with panic function locks series Exitlock and Sicur Panic

8/9	1300	2,360	1	1 59711 10 0 00 SB FR
8/9	1300	2,560	1	1 59711 16 0 00 SB FR

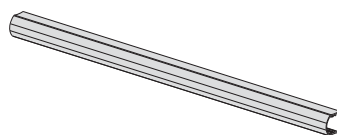

- Bar
- May be combined with panic exit devices series

1.59711.00.0.00.SB - 1.59711.10.0.00.SB
1.59711.06.0.00.SB - 1.59711.16.0.00.SB

- STANDARD FINISHES Matt black (fin. 00)

- BAR COLOR OPTIONS:

- satin-finished anodised aluminium (fin. 62)
- Anodised bronze (fin. 64)
- Brass-plated (fin. A1)
- Red (fin. 41)
- Green (fin. 43)
- White (fin. 45)
- Grey (fin. 97)

		1,000	1	1 06196 43 0
		1,200	1	1 06196 45 0



Technical features:

- Painted aluminum alloy/aluminum cover (59607 series)
- Galvanized steel internal components suitable for fire doors

Supplied as standard:

- Fixing screws
- ICIM and CE certificates of compliance
- Installation and maintenance Instructions

On request:

- Internal and external plates
- Version with microswitch

Finishes:

- STANDARD:
 - Painted black
- ON REQUEST:
 - Version 59607**
 - Painted white (fin. 45)
 - Painted gray (fin. 97)
 - PVD treatment: satin-finished stainless steel (fin. C2)
 - Painted steel grey (fin. B9)
 - Version 59617.00/12**
 - Painted white (fin. 45)
 - Painted gray (fin. 97)

Standards:

- CE marking in accordance with the regulation n° 305/2011
- CE mark according to the 89/106/EEC DIRECTIVE granted by ICIM

Hand:

0 = Non-handed

Bar to be ordered separately

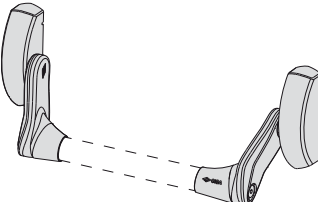
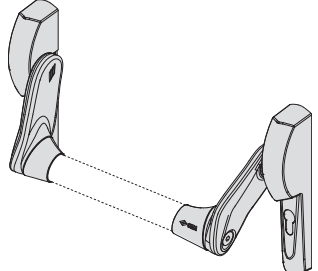

FAST Push

Type	Description	Spindle hole	L	Unit weight	Pieces	ITEM					
						Type	Dim.	Hand	Fin.	Pers.	Spec.
 <ul style="list-style-type: none"> • Can be combined with panic function locks • satin-finished PVD-treated stainless steel 	8/9	1,900	1	1	59607	10	0	00	00	FR	
	8/9	1,650	1	1	59607	10	0	C2	00	FR	
 <ul style="list-style-type: none"> • Black nylon casing • Can be combined with panic function locks 	8/9	72	1,350	1	1	59617	00	0	00	00	FR
	8/9	92	1,350	1	1	59617	12	0	00	00	FR

N.B. To install a bar on a double-leaf door, use the 59016+07063.61 serie (PERS. FR.)



Technical features:

- Steel case cover, painted black
- Supplied as standard:**
- Fixing screws
 - Instruction sheet
 - ICIM and CE Certification

Finishes:

- **STANDARD:**
 - painted black
- **ON REQUEST:**
 - painted white (fin. 45)
 - painted grey (fin. 97)

Standards:

- CE mark according to the 89/106/EEC DIRECTIVE granted by ICIM
- CE marking in accordance with the regulation n° 305/2011

Hand:

0 = Non-handed

Bar to be ordered separately
series 07007



CISA Prestige

Type	Description	Unit weight 	Pieces 	ITEM			
				Type	Dim.	Hand	Fin.

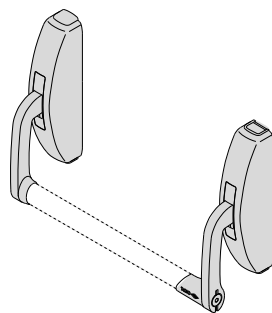

- May be combined with panic function mortice locks series 43100, 43200, 43600 and heavy duty mortice locks series 52760, 52761, 52840, 52842, 52844, 52860, 52862, 52864 (see locks for wooden doors)
- For assembly with fire resistant locks specify Spec. FR in your order
- Use inside plates item 1.07076.65.0 and 1.07066.66.0 to mount the panic exit device with matching lock

2,500 1 1 59321 10 0



Technical features:

- Stainless steel case cover

Supplied as standard:

- Fixing screws
- Instruction sheet
- ICIM and CE Certification

Standards:

- CE marking in accordance with the regulation n° 305/2011
- CE mark according to the 89/106/EEC DIRECTIVE granted by ICIM

Hand:

0 = Non-handed

Bar to be ordered separately



series 07007

CISA Prestige

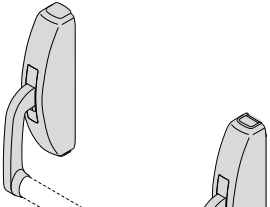
Type	Description	Unit weight Kg	Pieces	ITEM				
				Type	Dim.	Hand	Fin.	Pers. Spec.
	 <ul style="list-style-type: none"> • May be combined with panic function mortice locks series 43100, 43200, 43600 and heavy duty mortice locks series 52760, 52761, 52840, 52842, 52844, 52860, 52862, 52864 (see locks for wooden doors) • For assembly with fire resistant locks specify Spec. FR in your order • For use inside plates item 1.07076.65.0 and 1.07066.66.0 to mount the panic exit device with matching lock 	2,650	1	1	59371	10	0	



Technical features:

- Non-handed handle.
- Idle handle under no power input conditions.
- Key operated mechanical emergency system: the key will operate the handle. By removing the key the handle will be deactivated.
- Wiring system with connector for complete connection insulation.
- LED integral with handle body for door status visual indication.
- Nickel-plated steel case.
- Painted aluminum alloy cover.
- Electric hold-open device available.
- Power input through supplied Booster device.
- Rated voltage 12/24 V ac/dc.
- Operating voltage min. 5 V, max 28 V.

Supplied as standard:

- 8/9 mm square spindle.

On request:

- European profile cylinder.
- Timer item 1.07022.20.0.

Finishes:

- Black painted (RAL 9005).
- Grey painted (RAL 9006).

Hand:

0 = Non-handed

Type	Description	Faceplate	Unit weight 	Pieces 	ITEM			
					Type	Dim.	Hand	Fin.

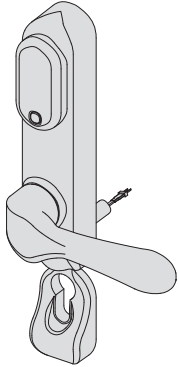

- Electrically enabled handle
- Can be installed with locks series 43100
- Handle to cylinder distance 72 mm
- STANDARD SUPPLY:
Connecting cable
fixing screws
- ON REQUEST:
Timer device 07022.20.0

1,150 1 1 07074 70 0

- Electrically enabled handle (A function only)
- Can be installed with locks series 43225, 43250, 43650, 43670, 43725, 43825
- Handle to cylinder distance 92 mm
- STANDARD SUPPLY:
Connecting cable
Fixing screws
- ON REQUEST:
Timer device 07022.20.0

1,150 1 1 07074 71 0

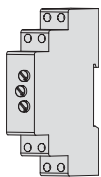

- Multiple scale timer

0,100 1 1 07022 20 0

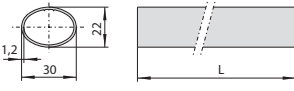
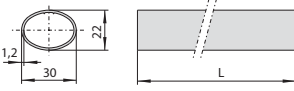
Type	Description	L	Unit weight Kg	Pieces	ITEM				
					Type	Dim.	Hand	Fin.	Pers. Spec.
 <ul style="list-style-type: none"> • Red painted steel oval shaped bar • AVAILABLE FINISHES: green painted (fin. 43) black painted (fin. 44) white painted (fin. 45) grey painted (fin. 97) painted steel grey (fin. B9) (Only versions .13 and .14) 	900	0,800	1	1	07007	13	0		
	1200	1,054	1	1	07007	14	0		
	1500	1,440	1	1	07007	15	0		
 <ul style="list-style-type: none"> • Stainless steel oval shaped horizontal bar 	900	0,800	1	1	07007	60	0		
	1200	1,070	1	1	07007	61	0		
	1500	1,400	1	1	07007	62	0		

Type	Description	For series/item	Unit weight 	Pieces 	ITEM				
					Type	Dim.	Hand	Fin.	Pers. Spec.

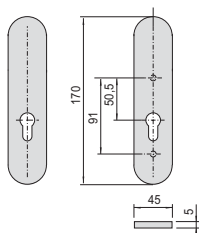

- Pair of plates with cylinder hole (replaces item 1 07070 12 0)

43000, 43020 0,200 6 1 07070 22 0

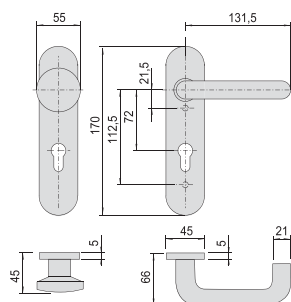

- Pair of plates with fixed handle knob and cylinder hole (replaces item 1 07070 14 0)

43000, 43020, 43025 0,600 6 1 07070 24 0

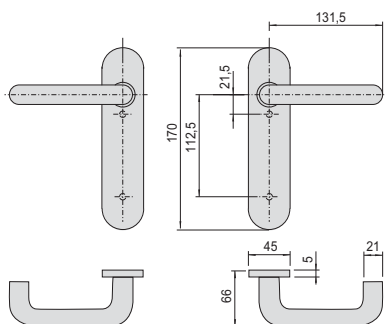

- Pair of plates with handles (replaces item 1 07070 15 0)

43000, 43020, 43025 0,410 6 1 07070 25 0

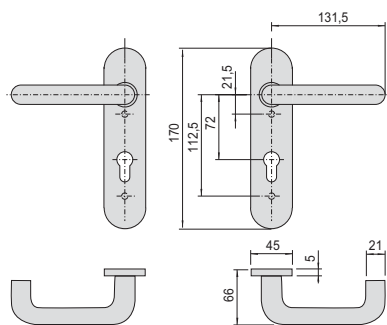

- Pair of plates with handles and cylinder hole (replaces item 1 07070 16 0)

43000, 43020, 43025 0,626 6 1 07070 26 0

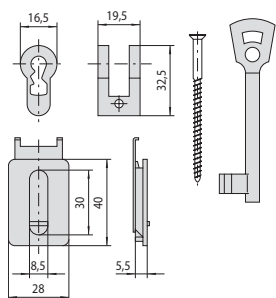



- Cylinder adaptor for bit keys (patent type)
- SUPPLIED AS STANDARD:
Bitted key
Fixing screws
2 nylon escutcheons with plug, to be combined with handles series 1.07070.12/14/16

43000, 43020, 43025 0,066 6 1 07071 10 0

Type	Description	For series/item	Unit weight Kg	Pieces	ITEM				
					Type	Dim.	Hand	Fin.	Pers.
	<ul style="list-style-type: none"> Galvanized steel striker 	43000, 43100	0,150	20	1	07073	20	0	
	<ul style="list-style-type: none"> Galvanized steel striker 	43000, 43100	0,117	20	1	07073	21	0	
	<ul style="list-style-type: none"> External plate only for reinforced assembly Can be installed with panic exit devices from the 59600 and 59711 series with centre distance 72 mm. (replaces item 1 07076 11 0) 	43000, 43020	0,204	6	1	07076	21	0	
	<ul style="list-style-type: none"> External plate with fixed knob Can be installed with panic exit devices from the 59600 and 59711 series with centre distance 72 mm. (replaces item 1 07076 13 0) 	43000, 43020, 43025	0,160	6	1	07076	23	0	
	<ul style="list-style-type: none"> External plate with fixed knob and cylinder hole Can be installed with panic exit devices from the 59600 and 59711 series with centre distance 72 mm. (replaces item 1 07076 14 0) 	43000, 43020, 43025	0,264	6	1	07076	24	0	

Type	Description	For series/item	Unit weight Pieces	ITEM			
				Type	Dim.	Hand	Fin.
	<ul style="list-style-type: none"> External plate with handle Can be installed with panic exit devices from the 59600 and 59711 series with centre distance 72 mm. (replaces item 1 07076 15 0) 	43000, 43020, 43025	0,250	6	1	07076 25 0	
	<ul style="list-style-type: none"> External plate with handle and cylinder hole Can be installed with panic exit devices from the 59600 and 59711 series with centre distance 72 mm. (replaces item 1 07076 16 0) 	43000, 43020, 43025	0,400	6	1	07076 26 0	
	<ul style="list-style-type: none"> Black painted inside plate Can be installed with panic exit devices To be combined with European profile cylinder protective roses on armoured doors FINISHES ON REQUEST: painted white (fin. 45) painted grey (fin. 97) 		0,106	6	1	07076 70 0	
	<ul style="list-style-type: none"> Satin-finished PVD-treated stainless steel 		0,106	6	1	07076 70 0 C2	
	<ul style="list-style-type: none"> Black painted inside plate Can be installed with mortice version panic exit devices To be combined with European profile cylinder protective roses on armoured doors FINISHES ON REQUEST: painted white (fin. 45) painted grey (fin. 97) 		0,106	6	1	07076 71 0	
	<ul style="list-style-type: none"> Satin-finished PVD-treated stainless steel 		0,106	6	1	07076 71 0 C2	
	<ul style="list-style-type: none"> Black painted steel extension bolts For use with: Panic exit devices series 59647 	1 07063 00 0, 1 07063 10 1, 1 07063 10 2	1,130	1	1	07081 12 0	

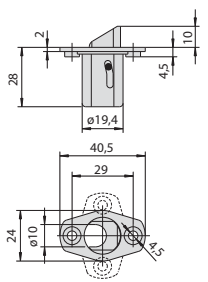
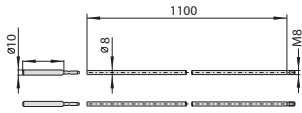
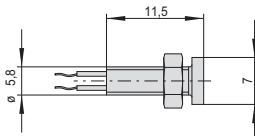
Type	Description	For series/item	Unit weight Kg	Pieces	ITEM			
					Type	Dim.	Hand	Fin.
	<ul style="list-style-type: none"> • Black painted inside plate • May be assembly with locks 72 mm centre distance 	59321, 59371	0,100	1	1	07076	65	0
	<ul style="list-style-type: none"> • Black painted inside plate • May be assembly with locks 92 mm centre distance 	59321, 59371	0,250	1	1	07076	66	0
	• Steel split splindle		0,060	6	1	07083	50	0
	• Steel split splindle		0,060	6	1	07083	51	0
	• Steel split splindle		0,060	6	1	07083	52	0
	• Steel split splindle		0,075	6	1	07083	53	0
	• Steel spindle		0,030	6	1	07083	70	0
	• Steel spindle		0,038	1	1	07085	75	0
	• Steel spindle		0,060	1	1	07085	76	0

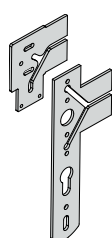
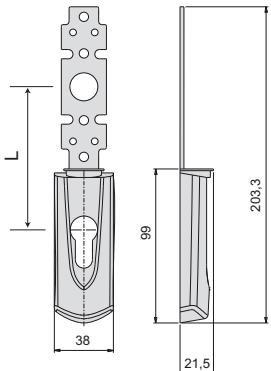
Type	Description	For series/item	Unit weight Kg	Pieces	ITEM			
					Type	Dim.	Hand	Fin.
	<ul style="list-style-type: none"> Automatic dogging device, steel 	43090, 43190, 43690	0,060	3	1	07089	50	0
	<ul style="list-style-type: none"> Zinc plated extension bolts SUPPLIED AS STANDARD: Pair of bolts diameter 8 mm. Hardened steel tip diameter 10 mm. item 1.06291.05.0 (Pcs. 2) 	16325, 17358, 46300, 46302, 46305, 46307, 46320, 46322, 46325, 46327, 46365, 46375, 56016, 57016, 57035, 57226, 57318, 57336, 57358, 57378	0,600	12	1	07088	03	0
	<ul style="list-style-type: none"> Open door indicator 	07074	0,005	1	1	07126	01	0
	<ul style="list-style-type: none"> Two-way two-colour LED, red LED V = 1.94 V and I = 5.43 mA, green LED V = 2.15 V, I = 5.06 mA 		0,005	6	1	07126	10	0
	<ul style="list-style-type: none"> 3 mm metal spacer for use with FAST TOUCH panic exit devices, mortice version 		0,200	1	1	07126	51	0
	<ul style="list-style-type: none"> Black painted outside plate Can be installed with Fast Touch panic exit devices series 59711 FINISHES ON REQUEST: painted white (fin. 45) painted grey (fin. 97) L=72 (dim. 61) L=85 (dim. 62) L=92 (dim. 63) satin-finished PVD-treated stainless steel 		0,110	6	1	07176	61	0
			0,110	6	1	07176	62	0
			0,110	6	1	07176	63	0
			0,110	6	1	07176	61	0 C2
			0,110	6	1	07176	62	0 C2
			0,110	6	1	07176	63	0 C2

Type	Description	For series/item	Unit weight Kg	Pieces	ITEM			
					Type	Dim.	Hand	Fin.

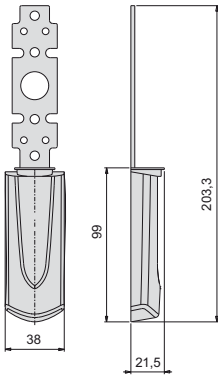

- Black painted outside plate
- Can be installed with Fast Touch panic exit devices series 59711
- FINISHES ON REQUEST:
painted white (fin. 45)
painted grey (fin. 97)

0,110 6 1 07176 66 0

- satin-finished PVD-treated stainless steel

0,110 6 1 07176 66 0 C2

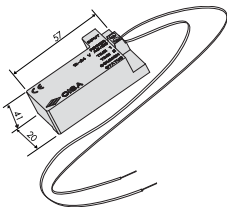

- Booster module:
- Voltage adaptor for voltages other than 12 V AC
- 24 V AC - 24 V DC and absorption reduction

13000, 13100, 0,850 1 1 07022 00 0
13200, 13210



AC POWER SUPPLY

- CE marked, compliant with Directives 2014/30/EU, 2014/35/EU Class 2 (double insulation)
- LPS source (in compliance with IEC 62368)
- OVP (overvoltage) and OCP (overcurrent) SELV protection
- UL94-V0 type plastics
- UL Listed or at least UL Recognized product

0,350 1 1 07302 08 0

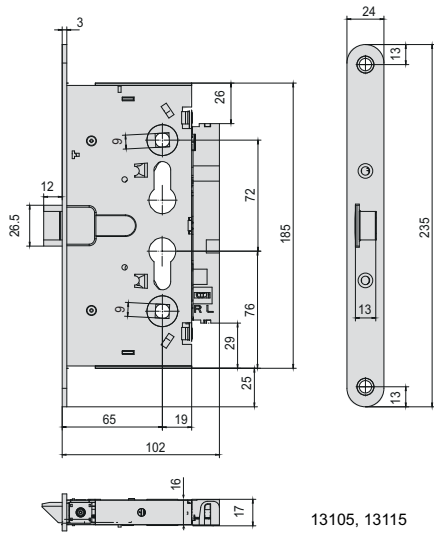

13105, 13115

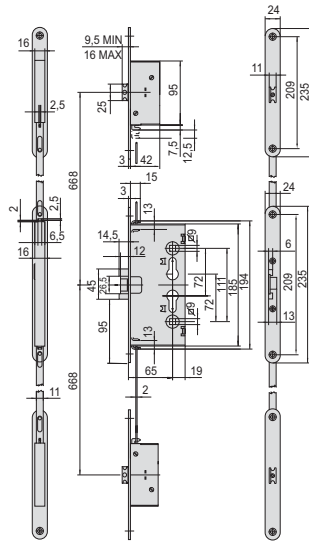

1.43025.65

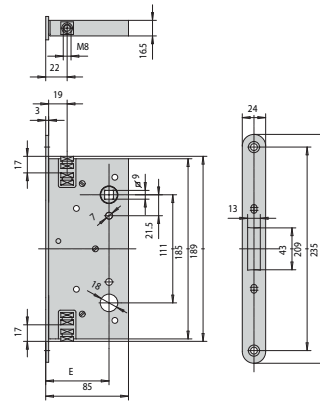

43190
E = 65 - 95

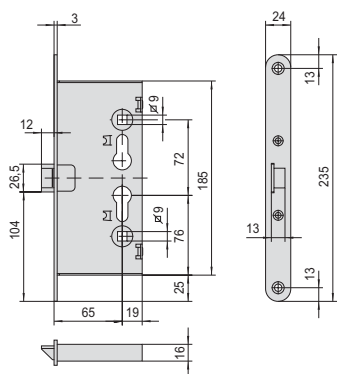

1.13100.65, 1.13110.65, 1.13160.65,
1.13200.65, 1.13210.65, 1.13260.65,
1.43000.65, 1.43014.65, 1.43110.65,
1.43112.65, 1.43114.65, 1.43160.65

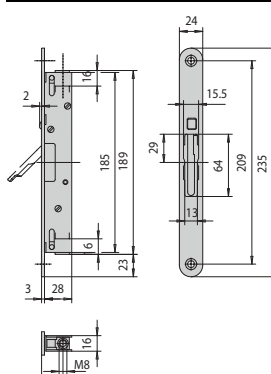

1.43091.00.0

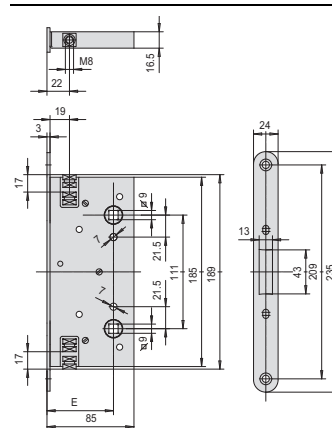

43191, 43192, 43193
E = 65 - 95

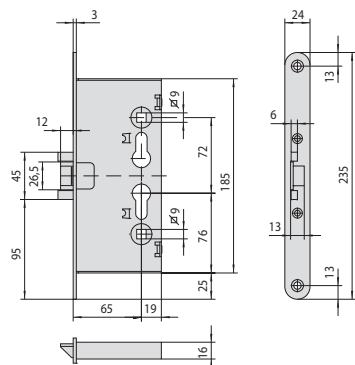

1.43020.65, 1.43024.65, 1.43120.65, 1.43130.65,

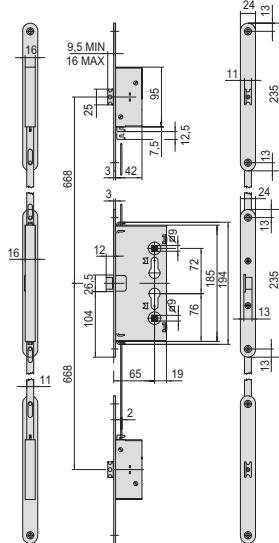

1.43015.65, 1.43115.65

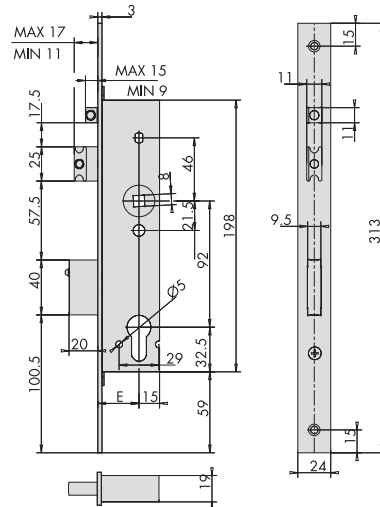

43225, 43235, 43236
E = 30-35-40-45

1

4

7

2

5

8

3

6

9

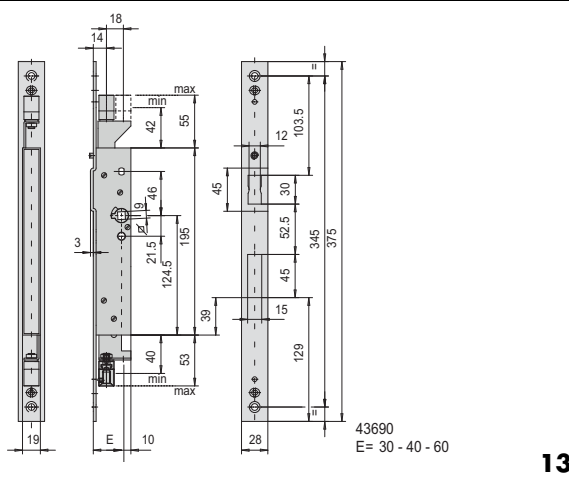
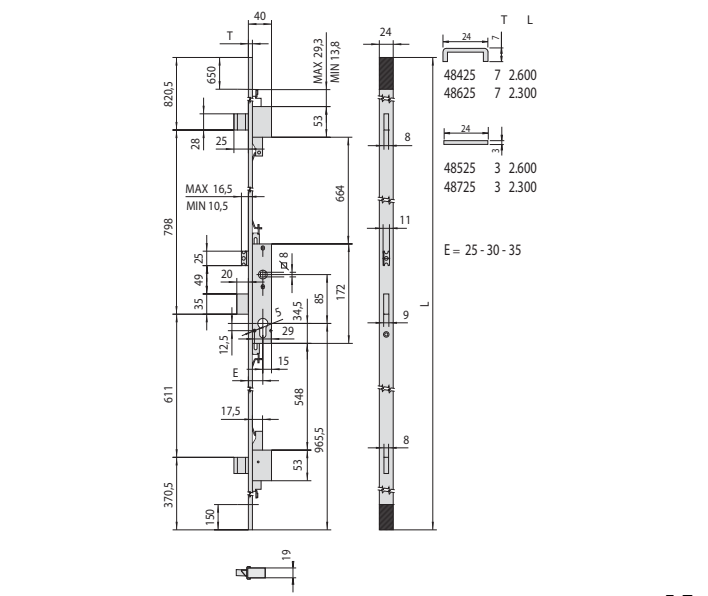
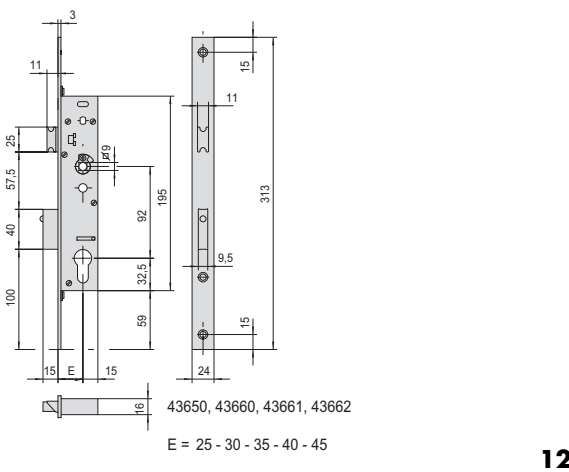
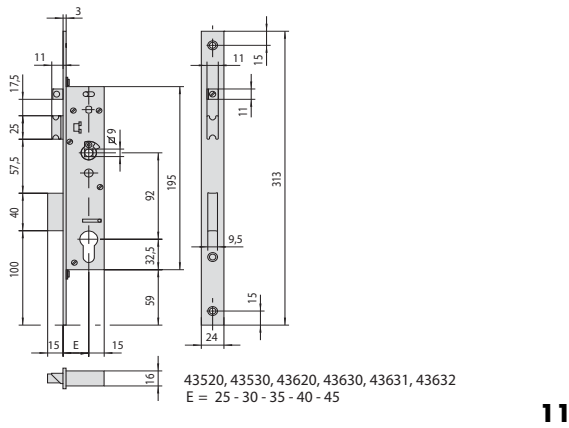
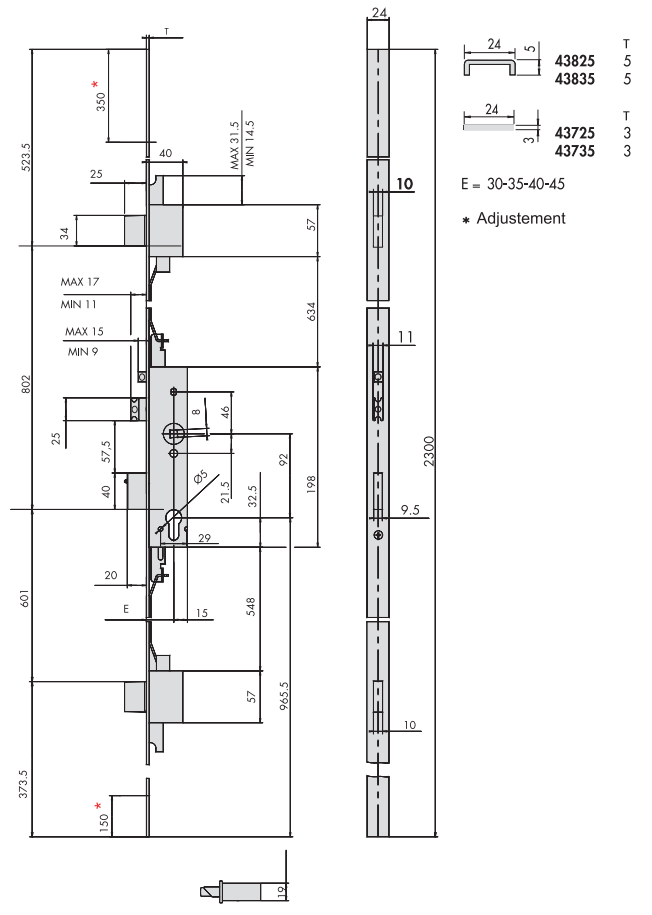
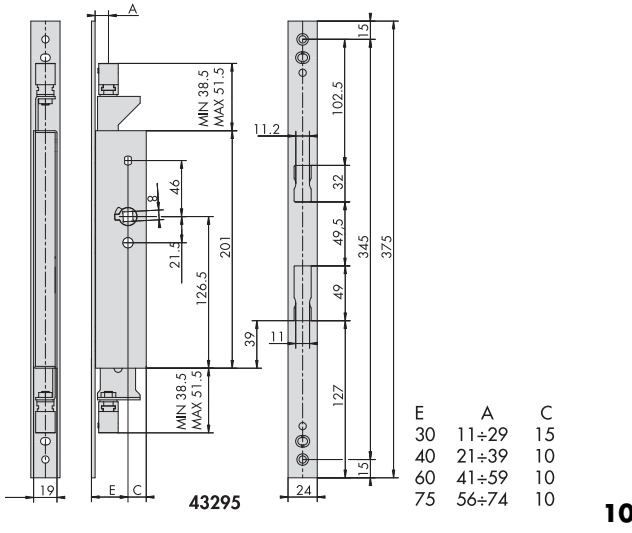



Locks and panic exit devices



Panic exit devices, rim version	492	Panic exit devices, mortice version	522
Cisa eFASTpanic exit devices	493	Panic function mortice locks with split follower	523
CISA FAST TOUCH series panic exit devices	494	List of certified products for sikurexit system	524
CISA FAST PUSH series panic exit devices	496	Sikurexit series panic function mortice locks	525
CISA FAST PUSH-PAD series panic exit devices	497	Adjustable metal strikers	529
Kit for additional locking points for Cisa FAST panic exit devices	498	Panic function cylinder mortice locks	531
Fast Flow emergency exit system	501	Exitlock panic function rim locks	532
CISA Prestige series panic exit devices	502	Exitlock panic function MORTICE locks	533
CISA Prestige inox series panic exit devices	503	Heavy Duty cylinder mortice locks	534
Kits for additional locking points for CISA Prestige panic exit devices	504	Cylinder mortice locks	536
Kits for additional locking points for CISA Prestige inox panic exit devices	506	Cisa FAST TOUCH series panic exit devices for panic function mortice locks	537
Horizontal bars for panic exit devices	508	Cisa FAST PUSH series panic exit devices for panic function mortice locks	538
Outside operation devices for panic exit devices FAST and Prestige	509	Electric handles	539
Electric handles	511	Accessories for panic exit devices	540
Electric strikers for panic exit devices	512	Dimensional drawings	544
Kit glass for assembling panic exit devices on glazed doors	513	Installation of panic exit devices for single doors	548
Cisa Polaris	515	Installation of panic exit devices for double doors	549
Accessories for panic exit devices	516		





eFAST

MOTORIZED SOLUTIONS
FOR EMERGENCY EXITS



CISA eFAST

CISA eFAST is a panic exit device with motorised opening which can be combined with multiple devices, such as keypads or card readers, to control access.

eFAST enhances the performance of the emergency exit door, turning it into an efficient and “smart” entrance.

CISA POLARIS



System with LED lights that can be installed on FAST Touch and eFAST.

Finding an emergency exit when visibility is low (if power fails or there is smoke) becomes easy.



cisa.com
allegion.com



ALLEGION



eFAST

Technical features:

- Aluminium/aluminium alloy cover
- Extruded aluminium bar, adjustable in length down to 600 mm for all versions

Operation:

- Latchbolt is withdrawn by motor allowing the door to be opened.
- Timed latch withdrawal from 3 to 30 seconds: By pushing the bar the latchboth is withdrawn allowing the door to be opened.

Supplied as standard:

- Special strikes
- Fixing screws
- Certificates of compliance
- Installation and maintenance instructions

On request:

- Outside access devices
- Extension bolts
- Fire door version with steel latchbolt (Spec. FR)

Finishes:

- STANDARD: Cover: black bar: red
- ON REQUEST
Cover: gray bar: gray (fin. 97)
Carter and bar painted steel gray (fin. B9)
Satin stainless steel PVD (fin. C2)

Standards:

- CE marking in compliance with the Construction Products Regulation 305/2011 issued by ICIM

Type	Description	For series/item	Kg	Pieces	ITEM			
					Type	Dim.	Hand	Fin.

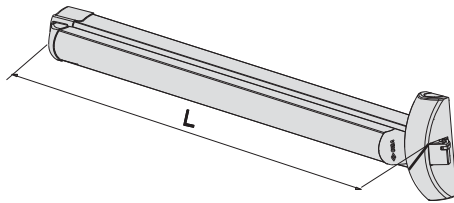

- Motorised modular panic exit device
- Supplied as standard
- strikes item 1.07071.20.0
- ON REQUEST
- Strike item 1.07072.21.0
- Outside access devices item 1.07078.36/38/68/69
- Only use outside access device item 1.07078.35.0 if the panic exit device is set to operate with one side locking point
- satin-finished PVD-treated stainless steel

1300	5,000	1	1	59851 09 0				
1200	4,000	1	1	59851 10 0				
840	3,500	1	1	59851 11 0				
1200	4,000	1	1	59851 10 0 C2				

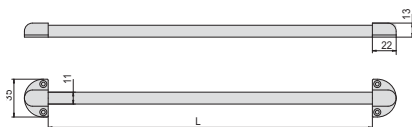

- Outside escutcheon with spring

300	0,100	10	1	06515 20 0				
600	0,150	10	1	06515 21 0				

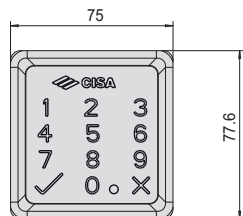

- Keypad
- Glossy black
- satin-finished nickel-plated chrome (fin. B1)

0,500	1	1	06525 77 0					
0,500	1	1	06525 77 0 B1					



Technical features:

- Painted aluminium body and bar
- Painted aluminum alloy cover
- Adjustable length up to 300 mm
- Chrome aluminum alloy self-locking latchbolt

Supplied as standard:

- Special strikers
- Fixing screws
- ICIM and CE certificates of compliance
- Installation and maintenance Instructions

On request:

- External drives
- Extension bolts
- Version with microswitch (spec. LA)
- Version with hold open device (spec FG).
- Fire door version with steel latchbolt (FR spec.).

Finishes:

- STANDARD: Cover: black bar: red
- ON REQUEST (only item 1.59811-10-0):
Cover: black bar: black (fin. 44)
Cover: white bar: white (fin. 45)
Cover: gray bar: gray (fin. 97)
Carter and bar painted steel grey (fin. B9)
PVD treatment: satin-finished stainless steel (fin. C2)

Standards:

- CE marking in compliance with the Construction Products Regulation 305/2011 issued by ICIM

Hand:

0 = Non-handed

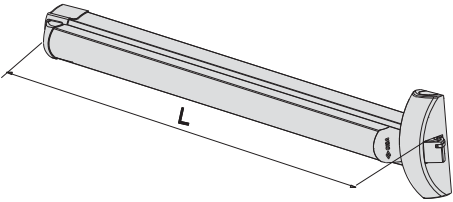
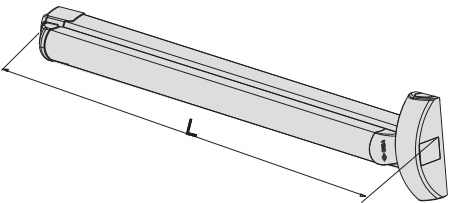

FAST Touch

Type	Description	L	Kg	Pieces	ITEM			
					Type	Dim.	Hand	Fin.
 <ul style="list-style-type: none"> • Dead-locking lateral latch bolt • SUPPLIED AS STANDARD: Striker item 1.07072.20.0 • ON REQUEST: Striker item 1.07072.21.0 outside operation devices item 1.07078.35/36/38/68/69 	1200	3,700	1	1	59801	10	0	
	840	2,684	1	1	59801	11	0	
 <ul style="list-style-type: none"> • MODULAR VERSION • Dead-locking lateral latch bolt with override option • SUPPLIED AS STANDARD: Striker item 1.07072.20.0 • Can be combined with: Pair of top/bottom latch bolts item 1.07063.61.0 Pair of lateral latch bolts item 1.07063.51.0 Pair of top/lateral latch bolts item 1.07063.66.1/2 Pair of top/bottom deadbolts item 1.07063.71.0 • ON REQUEST: Striker item 1.07072.21.0 Outside operation devices item 1.07078.36/38/68/69 	1300	3,760	1	1	59811	09	0	
	1200	3,472	1	1	59811	10	0	
	840	3,000	1	1	59811	11	0	
<ul style="list-style-type: none"> • satin-finished PVD-treated stainless steel 	1200	3,472	1	1	59811	10	0	C2
	840	2,684	1	1	59811	11	0	C2

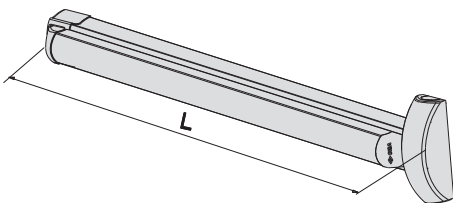
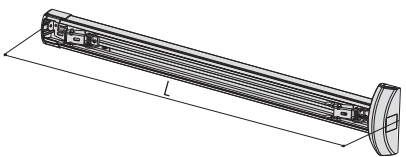
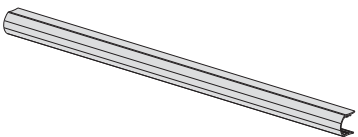
Type	Description	L	Unit weight 	Pieces 	ITEM				
					Type	Dim.	Hand	Fin.	Pers.
	<ul style="list-style-type: none"> • MODULAR VERSION WITHOUT CENTRAL latch bolt • Can be used with: <ul style="list-style-type: none"> Pair of top/bottom latch bolts item 1.07063.61.0 Pair of lateral latch bolts item 1.07063.51.0 Pair of top/lateral latch bolts item 1.07063.66.1/2 Pair of top/bottom deadbolts item 1.07063.71.0 • ON REQUEST: <ul style="list-style-type: none"> Striker item 1.07072.21.0 Outside operation devices item 1.07078.36/38/68/69 	1200	3,500	1	1	59816	10	0	
		840	3,000	1	1	59816	11	0	
	<ul style="list-style-type: none"> • MODULAR VERSION WITHOUT BAR • Can be used with: <ul style="list-style-type: none"> Pair of top/bottom latch bolts item 1.07063.61.0 Pair of lateral latch bolts item 1.07063.51.0 Pair of top/lateral latch bolts item 1.07063.66.1/2 Pair of top/bottom deadbolts item 1.07063.71.0 • ON REQUEST: <ul style="list-style-type: none"> Striker item 1.07072.21.0 Outside operation devices item 1.07078.36/38/68/69 	1200	2,472	1	1	59811	10	0	00 SB
	<ul style="list-style-type: none"> • Bar • May be combined with panic exit devices series 1.59811.10.0.00.00.SB • STANDARD FINISHES Black (fin. 00) • BAR COLOR OPTIONS: satin-finished anodised aluminium (fin. 62) Anodised bronze (fin. 64) Brass-plated (fin. A1) Red (fin. 41) Yellow (fin. 42) Green (fin. 43) White (fin. 45) Grey (fin. 97) Steel grey (B9) PVD treatment: satin-finished stainless steel (fin. C2) 	1200	1,000	1	1	06196	43	0	



Technical features:

- Painted aluminum alloy/aluminum cover
- Chrome aluminum alloy self-locking latchbolt.

Supplied as standard:

- Special strikers
- Fixing screws
- ICM and CE certificates of compliance
- Installation and maintenance Instructions

On request:

- External drives
- Extension bolts
- Microswitch
- Hold open device
- Fire door version with steel latchbolt (FR spec.).

Finishes:

- STANDARD: Painted black
- ON REQUEST (only item 1.59011.10.0): Painted white (fin. 45)
- Painted gray (fin. 97)
- Painted steel grey (fin. B9)
- PVD treatment: satin-finished stainless steel (fin. C2)

Standards:

- CE marking in accordance with the regulation n° 305/2011
- CE mark according to the 89/106/EEC DIRECTIVE granted by ICM

Hand:

0 = Non-handed

Bar to be ordered separately
series 07007



FAST Push

Type	Description	Kg	Pieces	ITEM			
				Type	Dim.	Hand	Fin.

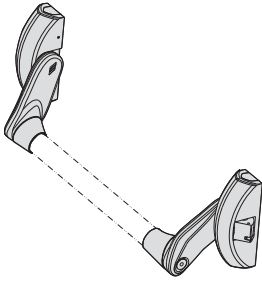

- Dead-locking lateral latch bolt
- SUPPLIED AS STANDARD:
Striker item 1.07072.20.0
- ON REQUEST:
Striker item 1.07072.21.0 outside operation devices
item 1.07078.35/36/38/68/69

2,150 1 1 59001 10 0

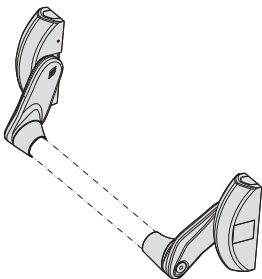

- MODULAR VERSION
- Dead-locking lateral latch bolt with override option
- SUPPLIED AS STANDARD:
Striker item 1.07072.20.0
- Can be combined with:
Pair of top/bottom latch bolts item 1.07063.61.0
Pair of lateral latch bolts item 1.07063.51.0
Pair of top/lateral latch bolts item 1.07063.66.1/2
Pair of top/bottom deadbolts item 1.07063.71.0
- ON REQUEST:
Striker item 1.07072.21.0
Outside operation devices item 1.07078.36/38/68/69

2,200 1 1 59011 10 0

- satin-finished PVD-treated stainless steel

2,266 1 1 59011 10 0 C2

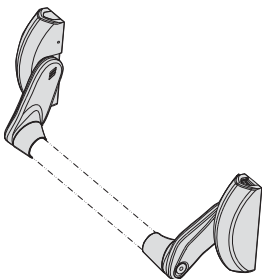

- MODULAR VERSION WITHOUT CENTRAL latch bolt
- Can be used with:
Pair of top/bottom latch bolts item 1.07063.61.0
Pair of lateral latch bolts item 1.07063.51.0
Pair of top/lateral latch bolts item 1.07063.66.1/2
Pair of top/bottom deadbolts item 1.07063.71.0
- ON REQUEST:
Striker item 1.07072.21.0
Outside operation devices item 1.07078.36/38/68/69

2,050 1 1 59016 10 0



Technical features:

- Painted aluminum alloy/aluminum cover
- Chrome aluminum alloy latchbolt

Supplied as standard:

- Special strikers
- Fixing screws
- Installation and maintenance Instructions

On request:

- External drives
- Extension bolts
- Version with hold open device.
- Fire door version with steel latchbolts (FR spec.).

Finishes:

- **STANDARD:**
Painted black
- **ON REQUEST (only item 1.59061.10.0):**
Painted white (fin. 45)
Painted gray (fin. 97)
Carter and bar painted steel grey (fin. B9)
PVD treatment: satin-finished stainless steel (fin. C2) item 1.59061.10.0

Standards:

- CE marking in compliance with the Construction Products Regulation 305/2011 issued by ICIM

Hand:

0 = Non-handed

FAST Push-pad



Type	Description	Kg	Pieces	ITEM			
				Type	Dim.	Hand	Fin. Pers. Spec.
	<ul style="list-style-type: none"> • Dead-locking lateral latch bolt • SUPPLIED AS STANDARD: Striker item 1.07072.20.0 • ON REQUEST: Striker item 1.07072.21.0 outside operation devices item 1.07078.35/36/38/68/69 	0,900	1	1	59051	10	0
	<ul style="list-style-type: none"> • MODULAR VERSION • Dead-locking lateral latch bolt with override option • SUPPLIED AS STANDARD: Striker item 1.07072.20.0 • Can be combined with: Pair of top/bottom latch bolts item 1.07063.61.0 Pair of lateral latch bolts item 1.07063.51.0 Pair of top/lateral latch bolts item 1.07063.66.1/2 Pair of top/bottom deadbolts item 1.07063.71.0 • ON REQUEST: Striker item 1.07072.21.0 Outside operation devices item 1.07078.36/38/68/69 	1,020	1	1	59061	10	0
	<ul style="list-style-type: none"> • satin-finished PVD-treated stainless steel 	0,860	1	1	59061	10	0 C2
	<ul style="list-style-type: none"> • MODULAR VERSION WITHOUT CENTRAL latch bolt • Can be used with: Pair of top/bottom latch bolts item 1.07063.61.0 Pair of lateral latch bolts item 1.07063.51.0 Pair of top/lateral latch bolts item 1.07063.66.1/2 Pair of top/bottom deadbolts item 1.07063.71.0 • ON REQUEST: Striker item 1.07072.21.0 Outside operation devices item 1.07078.36/38/68/69 	0,860	1	1	59066	10	0





Technical features:

- Painted aluminum alloy/aluminum cover
- Chrome aluminum alloy latchbolt
- Can be combined with the panic exit devices series FAST - EFAST
- For doors with 2500 mm maximum height and horizontal bar 1100 mm from the floor

Supplied as standard:

- Special strikers
- Fixing screws
- Installation and maintenance Instructions

On request:

- Extension bolts
- Fire door version with steel latchbolts (FR spec.).

Finishes:

- STANDARD:
Painted black
- ON REQUEST:
Painted white (fin. 45)
Painted gray (fin. 97)
Painted steel grey (fin. 89)
Satin-finished stainless steel treatment (fin. C2)



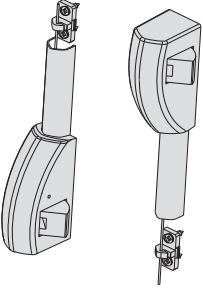
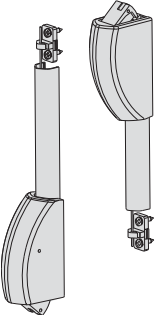

Standards:

- CE marking in compliance with the Construction Products Regulation 305/2011 issued by ICIM

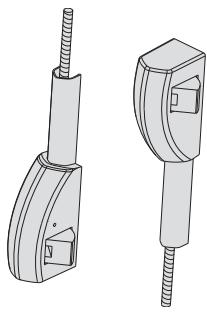
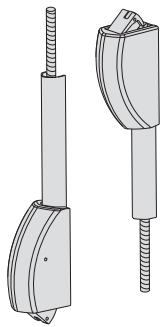
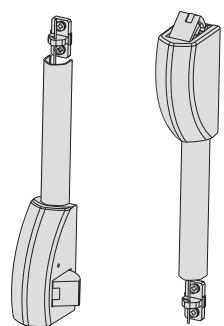
Hand:
0 = Non-handed

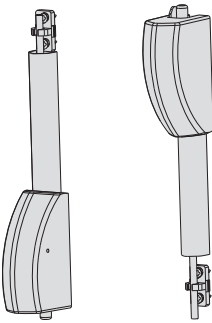
Type	Description	For series/item	Kg	Pieces	ITEM					
					Type	Dim.	Hand	Fin.	Pers. Spec.	
	<ul style="list-style-type: none"> • Pair of latch bolts for lateral locking point • SUPPLIED AS STANDARD: strikers item 1.07072.20 2 flexible cables 2 cable covers 2 connecting plates 2 cable feedthrough hooks • ON REQUEST Striker item 1.07072.21.0 	59011, 59016, 59061, 59065, 59811, 59816	2,000	1	1	07063	51	0		
		59011, 59016, 59061, 59065, 59811, 59816	2,100	1	1	07063	51	0	C2	
	<ul style="list-style-type: none"> • Pair of dead-locking latch bolts for top/bottom locking points • SUPPLIED AS STANDARD: Top strikers item 1.07072.20.0 Floor striker item 1.07072.27.0 2 flexible cables 2 cable covers 2 connecting plates 2 cable feedthrough hooks • ON REQUEST Striker item 1.07072.21.0 	59011, 59016, 59061, 59065, 59811, 59816	1,950	1	1	07063	61	0		
		59011, 59016, 59061, 59065, 59811, 59816	2,100	1	1	07063	61	0	C2	

Type	Description	For series/item	Unit weight Kg	Pieces	ITEM					
					Type	Dim.	Hand	Fin.	Pers. Spec.	
	<ul style="list-style-type: none"> • Dead-locking latchbolt set for lateral locking point • SUPPLIED AS STANDARD: Strikes item 1.07072.20 • 2 threaded rods • 2 bolt covers • 2 connecting plates • 2 bolt guide hooks • ON REQUEST Strike item 1.07072.21.0 	59011, 59016, 59061, 59065, 59811, 59816	2,000	1	1	07063	53	0		
		59011, 59016, 59061, 59065, 59811, 59816	2,100	1	1	07063	53	0	C2	
	<ul style="list-style-type: none"> • Dead-locking latchbolt set for top/bottom locking points • SUPPLIED AS STANDARD: Top strikes item 1.07072.20.0 Floor strike item 1.07072.27.0 2 threaded bolt extension rods 2 bolt extension rod cover 2 connecting plates 2 rod guide hooks • ON REQUEST Strike item 1.07072.21.0 	59011, 59016, 59061, 59065, 59811, 59816	1,950	1	1	07063	63	0		
		59011, 59016, 59061, 59065, 59811, 59816	2,100	1	1	07063	63	0	C2	
	<ul style="list-style-type: none"> • Pair of latch bolts for top dead-locking locking point and bottom lateral locking point • SUPPLIED AS STANDARD: striker item 1.07072.20 • 2 flexible cables • 2 cable covers • 2 connecting plates • 2 cable feedthrough hooks • ON REQUEST Striker item 1.07072.21.0 	59011, 59016, 59061, 59065, 59811, 59816	1,950	1	1	07063	66	1		
		59011, 59016, 59061, 59065, 59811, 59816	1,950	1	1	07063	66	2	C2	
		59011, 59016, 59061, 59065, 59811, 59816	1,950	1	1	07063	66	1	C2	
		59011, 59016, 59061, 59065, 59811, 59816	1,950	1	1	07063	66	2	C2	

Type	Description	For series/item	Unit weight Kg	Pieces	ITEM				
					Type	Dim.	Hand	Fin.	Pers. Spec.
	<ul style="list-style-type: none"> • Pair of deadbolts for top/bottom locking points for swinging doors • SUPPLIED AS STANDARD: Top strikers item 1.07072.25.0 and item 1.07072.26.0 Floor striker item 1.07072.25.0 2 threaded bolts 2 bolt covers 2 bolt guide hooks 2 connecting plates 	59011, 59016, 59061, 59065, 59811, 59816	2,100	1	1	07063	71	0	
	<ul style="list-style-type: none"> • satin-finished PVD-treated stainless steel 	59011, 59016, 59061, 59065, 59811, 59816	1,000	1	1	07063	71	0	C2
	<ul style="list-style-type: none"> • Additional lateral latch bolt • SUPPLIED AS STANDARD: Strikers item 1.07072.20.0 	1 07063 51 0	0,600	1	1	07063	26	1	
	<ul style="list-style-type: none"> • satin-finished PVD-treated stainless steel 	1 07063 51 0	0,600	1	1	07063	26	2	C2
	<ul style="list-style-type: none"> • Top extension bolt kit complete with: Flexible cable Cable cover Cable feedthrough hook • For doors with 3500 mm maximum height and horizontal bar 1100 mm from the floor 	1 07063 51 0, 1 07063 61 0, 1 07063 66 1	0,500	1	1	07064	51	0	
	<ul style="list-style-type: none"> • satin-finished PVD-treated stainless steel 		0,384	1	1	07064	51	0	C2
	<ul style="list-style-type: none"> • Top extension bolt kit complete with: Threaded bolt Bolt cover Bolt guide hook • For doors with 3500 mm maximum height and horizontal bar 1100 mm from the floor 	1 07063 71 0 1 07063 53 0 1 07063 63 0	0,384	1	1	07064	71	0	
	<ul style="list-style-type: none"> • satin-finished PVD-treated stainless steel 		0,384	1	1	07064	71	0	C2



FAST Flow



Technical features:

- Patented deadbolt locking system
- Painted aluminum alloy/aluminum cover
- Forward strike 13.5 mm
- Deadbolt diameter 15 mm
- Adjustable strikers for overlap height 10 mm - 20 mm (patented system)

Supplied as standard:

- 3 Locking point panic exit device (**do not use standard panic devices**)
- Kit of rods and latch bolt for top/bottom locking point
- Fixing screws
- Installation and maintenance Instructions

On request:

- External drives
- Bar to ordered separately series 07007

Finishes:

- STANDARD: Painted black
- ON REQUEST: Painted gray (fin. 97)
Painted white (fin. 45)
Grey stainless steel B9
PVD satin-finished stainless steel treatment C2

Hand:
0 = Non-handed

Bar to be ordered separately

series 07007

Standards:

- CE marking in accordance with the regulation n° 305/2011

Type	Description	Kg	Pcs	ITEM				
				Type	Dim.	Hand	Fin.	Pers. Spec.

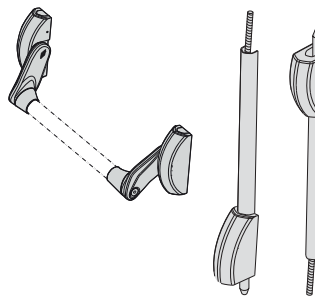

- Modular panic exit device complete with top/bottom closing rods
- SUPPLIED AS STANDARD:
 - 3 locking point panic exit device
 - 2 adjustable top strikers
 - 2 floor strikers
 - 2 threaded rods
 - 2 rod covers
 - 2 rod guide hooks
 - 1 pair of top/bottom deadbolts

4,055 1 1 59014 10 0

Use only the panic devices included in the kit. The product does not work if combined with a standard panic device



Technical features:

- Steel case cover, painted black
- Chrome-plated aluminium alloy self-locking latch

Supplied as standard:

- Strikers
- Fixing screws
- Instruction sheet
- ICIM and CE Certification

On request:

- Microswitch
- Hold-open device
- Fire resistant version with steel latch (spec. FR)

Finishes:

- STANDARD:
 - painted black
- ON REQUEST:
 - painted white (fin. 45)
 - painted grey (fin. 97)

Standards:

- CE marking in compliance with the Construction Products Regulation 305/2011 issued by ICIM

Hand:
0 = Non-handed

Bar to be ordered separately



series 07007

CISA Prestige

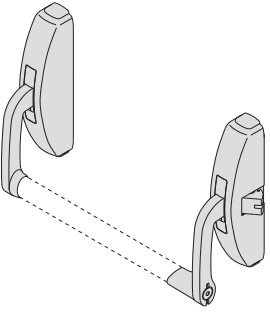
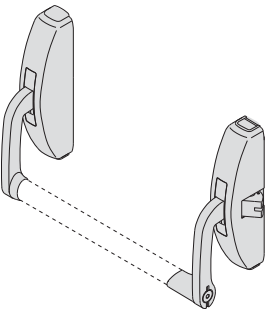
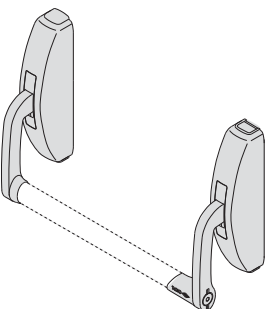
Type	Description	Kg	Box	ITEM			
				Type	Dim.	Hand	Pers. Spec.
	<ul style="list-style-type: none"> • Lateral latch-bolt • SUPPLIED AS STANDARD: Strikers item 1.07072.20.0 • ON REQUEST: Outside operation devices item 1.07078.65/68/69 	2,850	1	1	59301	10	0
	<ul style="list-style-type: none"> • MODULAR VERSION • Lateral latch-bolt which can be deactivated • SUPPLIED AS STANDARD: Strikers item 1.07072.20.0 • Can be used with: Pair of top/bottom latch-bolts item 1.07063.30.0 Pair of lateral latch-bolts item 1.07063.20.0 Pair of top/lateral latch-bolts item 1.07063.35.1/2 Pair of top/bottom deadbolts item 1.07063.40.0 • ON REQUEST: Outside operation device item 1.07078.68/69 	2,846	1	1	59311	10	0
	<ul style="list-style-type: none"> • MODULAR VERSION • Can be used with: Pair of top/bottom latch-bolts item 1.07063.30.0 Pair of lateral latch-bolts item 1.07063.20.0 Pair of top/lateral latch-bolts item 1.07063.35.1/2 Pair of top/bottom deadbolts item 1.07063.40.0 • ON REQUEST: Outside operation device item 1.07078.68/69 	2,666	1	1	59316	10	0



Technical features:

- Stainless steel case cover
- Chrome-plated aluminium alloy self-locking latch with PVD coating.

Supplied as standard:

- Strikers
- Fixing screws
- Instruction sheet
- ICIM and CE Certification

On request:

- Microswitch version (spec. LA)
- Hold-open device version (spec. FG)
- Fire door version with steel latchbolt with PVD coating (spec. FR)

Standards:

- CE marking in compliance with the Construction Products Regulation 305/2011 issued by ICIM

Hand:
0 = Non-handed

Bar to be ordered separately
series 07007

CISA Prestige Inox

Type	Description	Unit weight	Pieces	ITEM			
				Type	Dim.	Hand	Fin. Pers. Spec.

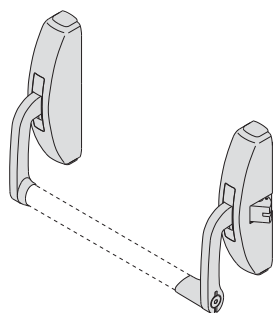

- Lateral latchbolt
- SUPPLIED AS STANDARD:
Strikers item 1.07072.70.0
- ON REQUEST:
Outside operation devices item 1.07078.65/68/69.0.C2

2,864 1 1 59351 10 0

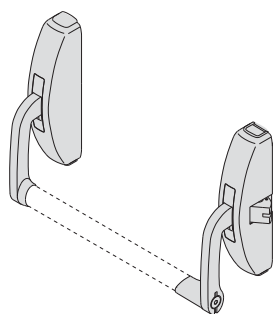

- MODULAR VERSION
- Lateral latchbolt which can be disconnected
- SUPPLIED AS STANDARD:
Strikers item 1.07072.70.0
- Can be used with:
Pair of top/bottom latchbolts item 1.07063.31.0
Pair of lateral latchbolts item 1.07063.21.0
Pair of top/lateral latchbolts item 1.07063.36.1/2
Pair of top/bottom deadbolts item 1.07063.41.0
- ON REQUEST:
Outside operation device 1.07078.68/69.0.C2

3,002 1 1 59361 10 0

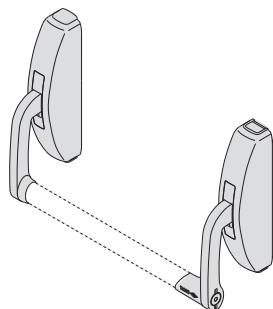

- MODULAR VERSION
- Can be used with:
Pair of top/bottom latchbolts item 1.07063.31.0
Pair of lateral latchbolts item 1.07063.21.02
Pair of top/lateral latchbolts item 1.07063.36.1/2
Pair of top/bottom deadbolts item 1.07063.41.0
- ON REQUEST:
Outside operation device 1.07078.68/69.0.C2

2,700 1 1 59366 10 0



Technical features:

- Steel case cover, painted black
- Chrome-plated aluminium alloy latch bolt and deadbolt
- For doors with 2500 mm maximum height and horizontal bar 1100 mm from the floor

Supplied as standard:

- Strikers
- Fixing screws
- Instruction sheet
- ICIM and CE Certification

On request:

- Fire resistant version with steel latch (spec. FR) item 1.07063.20/30/35.0

Finishes:

- STANDARD:
 - painted black
- ON REQUEST:
 - painted white (fin. 45)
 - painted grey (fin. 97)

Hand:

0 = Non-handed

1 = R.H. inwards

2 = L.H. inwards

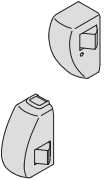
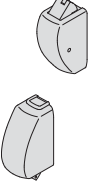
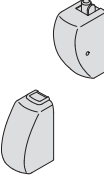
Type	Description	For series/item	Kg	Pieces	ITEM					
					Type	Dim.	Hand	Fin.	Pers.	Spec.
	<ul style="list-style-type: none"> • Pair of latch-bolts for lateral locking points • SUPPLIED AS STANDARD: 2 strikers item 1.07072.20.0 • ON REQUEST: Rods item 1.07081.06.0 	59311, 59316	1,062	1	1	07063	20	0		
	<ul style="list-style-type: none"> • Pair of dead-locking latch-bolts for top/bottom locking points • SUPPLIED AS STANDARD: upper strikers item 1.07072.20.0 Floor striker item 1.07072.28.0 • ON REQUEST: Rods item 1.07081.06.0 	59311, 59316	1,000	1	1	07063	30	0		
	<ul style="list-style-type: none"> • Pair of latch-bolts for top/bottom locking points for swinging doors • SUPPLIED AS STANDARD: Upper strikers item 1.07072.25.0 and 1.07072.26.0 Floor striker item 1.07072.25.0 • ON REQUEST: Rods item 1.07081.06.0 	59311, 59316	1,000	1	1	07063	40	0		

Type	Description	For series/item	Unit weight Pieces	ITEM			
				Type	Dim.	Hand	Fin.

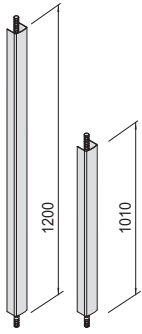

- Black painted set of extension bolts
- Black painted case cover
- To be used with latch-bolts item 1.07063.20/30/35/40.0

59311, 59316 1,220 1 1 07081 06 0

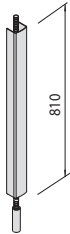

- Black painted top extension bolt set
- Black painted case cover
- For doors with 3500 mm maximum height and horizontal bar 1100 mm from the floor

07063 0,652 1 1 07064 60 0







Technical features:

- Stainless steel case cover
- Chrome-plated aluminium alloy latch bolt and deadbolt with PVD coating.
- For doors with 2500 mm maximum height and horizontal bar 1100 mm from the floor

Supplied as standard:

- Strikers
- Fixing screws
- Instruction sheet
- ICIM Certification

On request:

- Fire resistant version with steel latch (spec. FR)



Hand:

0 = Non-handed

1 = R.L. outwards

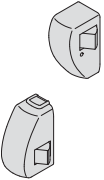
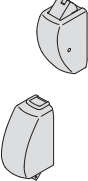
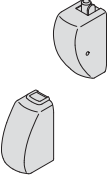
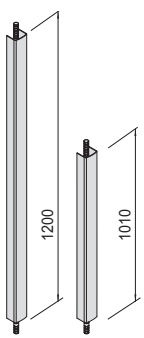
2 = L.H. outwards

Type	Description	For series/item	Unit weight	Pieces	ITEM					
					Type	Dim.	Hand	Fin.	Pers.	Spec.
	<ul style="list-style-type: none"> • Pair of latch-bolts for lateral locking points • SUPPLIED AS STANDARD: 2 strikers item 1.07072.70.0 • ON REQUEST: Rods item 1.07081.61.0 	59361, 59366	1,220	1	1	07063	21	0		
	<ul style="list-style-type: none"> • Pair of dead-locking latch-bolts for top/bottom locking points • SUPPLIED AS STANDARD: upper strikers item 1.07072.70.0 Floor striker item 1.07072.78.0 • ON REQUEST: Rods item 1.07081.61.0 	59361, 59366	1,080	1	1	07063	31	0		
	<ul style="list-style-type: none"> • Pair of latch-bolts for top/bottom locking points for swinging doors • SUPPLIED AS STANDARD: Upper strikers item 1.07072.75.0 and 1.07072.76.0 Floor striker item 1.07072.75.0 • ON REQUEST: Rods item 1.07081.61.0 	59361, 59366	1,000	1	1	07063	41	0		
	<ul style="list-style-type: none"> • Stainless steel extension bolts • Stainless steel case cover • To be used with latch-bolts item 1.07063.21/31/36/41.0 	59361, 59366	1,196	1	1	07081	61	0		

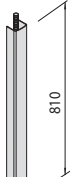
Type	Description	For series/item	 Unit weight	 Pieces	ITEM				
					Type	Dim.	Hand	Fin.	Pers. Spec.
	<ul style="list-style-type: none"> • Stainless steel top extension bolt set • Stainless steel case cover • For doors with 3500 mm maximum height and horizontal bar 1100 mm from the floor 	07063	0,500	1	1	07064	61	0	

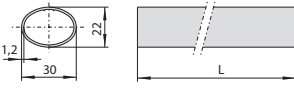
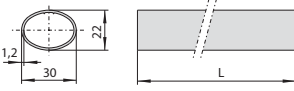
Type	Description	L	Unit weight Kg	Pieces	ITEM				
					Type	Dim.	Hand	Fin.	Pers. Spec.
 <ul style="list-style-type: none"> • Red painted steel oval shaped bar • AVAILABLE FINISHES: green painted (fin. 43) black painted (fin. 44) white painted (fin. 45) grey painted (fin. 97) painted steel grey (fin. B9) (Only versions .13 and .14) 	900	0,800	1	1	07007	13	0		
	1200	1,054	1	1	07007	14	0		
	1500	1,440	1	1	07007	15	0		
 <ul style="list-style-type: none"> • Stainless steel oval shaped horizontal bar 	900	0,800	1	1	07007	60	0		
	1200	1,070	1	1	07007	61	0		
	1500	1,400	1	1	07007	62	0		

Technical features:

- Aluminium plate

Supplied as standard:

- Cylinders with 3 keys (where these are provided for)
- Fixing screws
- Instruction sheet

On request:

- Microswitch, only for item 107078.68/69
- For cylinder replacement, use 30/10 single cylinders

Hand:
0 = Non-handed

Type	Description	For series/item	Unit weight 	Pieces 	ITEM			
					Type	Dim.	Hand	Fin. Pars. Spec.

	<ul style="list-style-type: none"> • Fixed knob, centre distance 43 mm • The key operates the latchbolt • Nickel-plated cylinder • Only for 1-locking point panic exit devices • FINISHES ON REQUEST painted STEEL GREY (fin. B9) painted WHITE (fin. 45) painted GREY (fin. 97) 	59001, 59051, 59801	0,600	1	1 07078 35 0		
	<ul style="list-style-type: none"> • satin-finished PVD-treated stainless steel (fin C2) 		0,600	1	1 07078 35 0 C2		

	<ul style="list-style-type: none"> • Fixed knob, centre distance 90 mm • The key operates the latchbolt • Nickel-plated cylinder • Only for 1-locking point panic exit devices • FINISHES ON REQUEST painted STEEL GREY (fin. B9) painted WHITE (fin. 45) painted GREY (fin. 97) 	59301	0,600	1	1 07078 65 0		
	<ul style="list-style-type: none"> • satin-finished PVD-treated stainless steel (fin C2) 		0,600	1	1 07078 65 0 C2		

	<ul style="list-style-type: none"> • Plate with low profile handle • The handle is disactivated with the key • Nickel-plated cylinder • Non-removable key setting (optional) • FINISHES ON REQUEST: painted STEEL GREY (fin. B9) painted WHITE (fin. 45) painted GREY (fin. 97) 	59001, 59011, 59016, 59051, 59061, 59066, 59801, 59811, 59816	0,600	20	1 07078 36 0		
	<ul style="list-style-type: none"> • satin-finished PVD-treated stainless steel (fin C2) 		1,308	1	1 07078 36 0 C2		
	<ul style="list-style-type: none"> • Version without cylinder 		1,308	1	1 07078 36 0 00 SH		

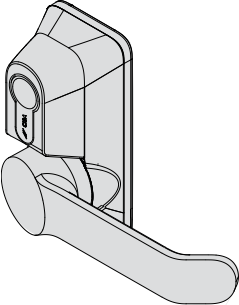
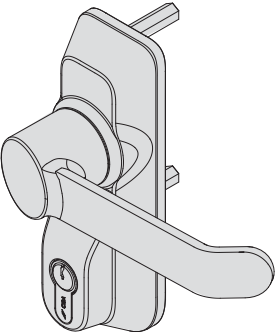
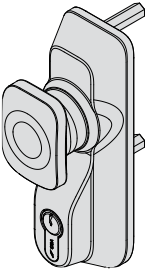
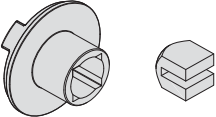
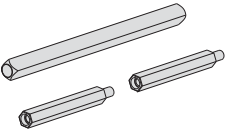
Type	Description	For series/item	Unit weight Kg	Pieces	ITEM			
					Type	Dim.	Hand	Fin.
	<ul style="list-style-type: none"> • Black painted plate with handle • Handle deactivated by key • Nickel-plated cylinder • Non-removable key setting (optional) • FINISHES ON REQUEST: painted STEEL GREY (fin. B9) painted WHITE (fin. 45) painted GREY (fin. 97) 	59001, 59011, 59016, 59051, 59061, 59066, 59801, 59811, 59816	0,600	1	1	07078	38	0
	<ul style="list-style-type: none"> • satin-finished PVD-treated stainless steel (fin C2) 		0,500	1	1	07078	38	0 C2
	<ul style="list-style-type: none"> • Version without cylinder 		0,500	1	1	07078	38	0 00 SH
	<ul style="list-style-type: none"> • Black painted plate with handle • Handle deactivated by key • Nickel-plated cylinder • Non-removable key setting (optional) • FINISHES ON REQUEST: painted STEEL GREY (fin. B9) painted WHITE (fin. 45) painted GREY (fin. 97) 	59001, 59011, 59016, 59051, 59061, 59066, 59301, 59311, 59316, 59801, 59811, 59816	0,900	12	1	07078	68	0
	<ul style="list-style-type: none"> • satin-finished PVD-treated stainless steel (fin C2) 		1,200	1	1	07078	68	0 C2
	<ul style="list-style-type: none"> • Version without cylinder 		1,200	1	1	07078	68	0 00 SH
	<ul style="list-style-type: none"> • Black painted knob • Knob disabled with the key • Nickel-plated cylinder • Non-removable key setting (optional) • FINISHES ON REQUEST: painted STEEL GREY (fin. B9) painted WHITE (fin. 45) painted GREY (fin. 97) 	59001, 59011, 59016, 59051, 59061, 59066, 59301, 59311, 59316, 59801, 59816	0,800	1	1	07078	69	0
	<ul style="list-style-type: none"> • PVD inox satinato (fin C2) 		0,850	1	1	07078	69	0 C2
	<ul style="list-style-type: none"> • Version without cylinder 		0,850	1	1	07078	69	0 00 SH
	<ul style="list-style-type: none"> • Follower and adaptor for cylinder only installation 		0,170	1	1	06198	70	0
	<ul style="list-style-type: none"> • Additional locking point kit for versions 1.07078.36/38 for doors 80 mm to 130 mm • For versions 1.07078.68/69 for doors 100 mm to 130 mm 		0,099	1	1	06316	04	0



Technical features:

- Non-handed handle.
- Idle handle under no power input conditions.
- Key operated mechanical emergency system: the key will operate the handle. By removing the key the handle will be deactivated.
- Wiring system with connector for complete connection insulation.
- LED integral with handle body for door status visual indication.
- Nickel-plated steel case.
- Painted aluminum alloy cover.
- Electric hold-open device available.
- Powered through booster device
- Rated voltage 12/24 V ac/dc.
- Operating voltage min. 5 V, max 28 V.

Supplied as standard:

- Cylinder item 1.0G304.02.0.12.
- Booster module item 1.07022.01.0.
- 8/9 mm square spindle.

On request:

- Timer item 1.07022.20.0

Finishes:

- Black painted (RAL 9005).
- Grey painted (RAL 9006).

Type	Description	Faceplate	Unit weight	Pieces	ITEM			
					Type	Dim. Hand	Fin.	Pers. Spec.

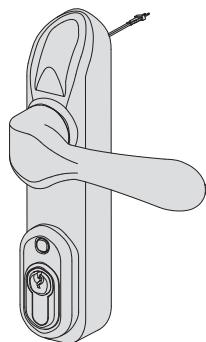

- Electrically enabled handle
- Can be installed with panic exit devices series FAST and Cisa Prestige
- Painted Black
- STD SUPPLY:
Booster device 1.07022.01.0
Connecting cable
fixing screws
- ON REQUEST:
Timer device 1.07022.20.0

1,200 1 1 07074 80 0



Technical features:

- To be coupled with panic exit devices with side latch
- Rated voltage :
 - 12 V ac
 - 12 and 24 V dc
- Zinc-plated steel case
- Lacquered aluminium alloy casing
- Chrome-plated aluminium alloy striker

Supplied as standard:

- Nylon spacers item 1.7089.12.0 (black standard)
- Fixing screws
- Instruction sheet

Finishes:

- **STANDARD:**
 - black case casing
- **ON REQUEST:**
 - stainless steel grey (fin. B9)
 - white case cover (fin. 45)
 - grey case cover (fin. 97)
 - satfin-finished stainless steel (fin. C2)

Hand:

0 = Non-handed

Type	Description	Facaplate	Unit weight Kg	Pieces	ITEM			
					Type	Dim.	Hand	Fin. Pers. Spec.
	<ul style="list-style-type: none"> • Without hold-open catch mechanism • 12 V ac - Current absorption 0,25A 	0,500	1	1	07083	05	0	
	<ul style="list-style-type: none"> • Without hold-open catch mechanism • 12 V dc - Current absorption 0,2A 	0,500	1	1	07083	06	0	
	<ul style="list-style-type: none"> • Without hold-open catch mechanism • 24 V dc - Current absorption 0,15A 	0,500	1	1	07083	07	0	
	<ul style="list-style-type: none"> • Without hold-open catch mechanism • 1 microswitch • 12 V ac - Current absorption 0,25A 	0,500	1	1	07083	80	0	
	<ul style="list-style-type: none"> • Without hold-open catch mechanism • 1 microswitch • 12 V dc - Current absorption 0,2A 	0,650	1	1	07083	81	0	
	<ul style="list-style-type: none"> • Without hold-open catch mechanism • 1 microswitch • 24 V dc - Current absorption 0,15A 	0,500	1	1	07083	82	0	
	<ul style="list-style-type: none"> • With hold-open catch mechanism • 12 V ac - Current absorption 0,8A 	0,628	12	1	07083	90	0	
	<ul style="list-style-type: none"> • With live coils • 12 V dc - Current absorption 0,2A 	0,634	1	1	07083	40	0	
	<ul style="list-style-type: none"> • With live coils • 24 V dc - Current absorption 0,15A 	0,500	1	1	07083	41	0	

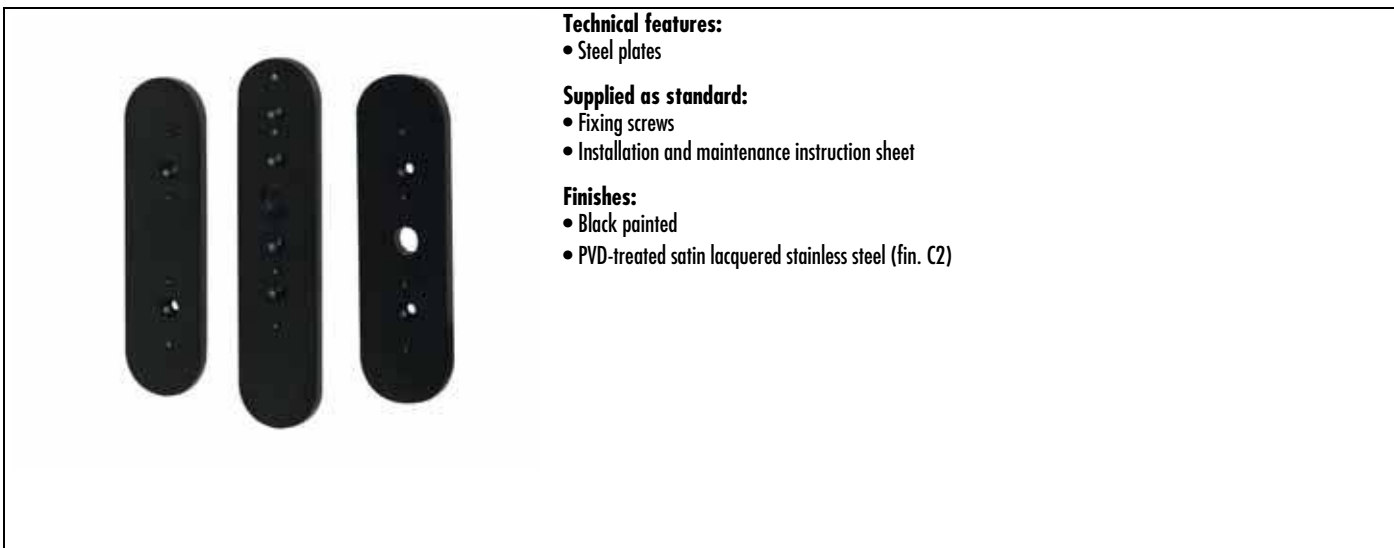

Technical features:

- Steel plates

Supplied as standard:

- Fixing screws
- Installation and maintenance instruction sheet

Finishes:

- Black painted
- PVD-treated satin lacquered stainless steel (fin. C2)

Type	Description	Unit weight	Pieces	ITEM				
				Type	Dim.	Hand	Fin.	Pers. Spec.

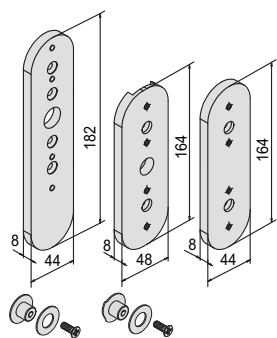

- Glass Kit for FAST panic exit devices
- Painted black

1,140 1 1 07090 01 0

- Glass Kit for FAST panic exit devices
- satin-finished PVD-treated stainless steel

1,300 1 1 07090 01 0 C2

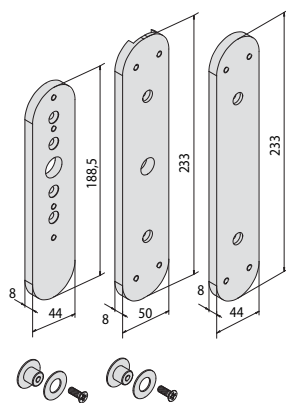

- Kit Glass for CISA Prestige panic exit devices
- Black painted

0,200 1 1 07090 05 0

- Kit Glass for CISA Prestige panic exit devices
- PVD-treated satin lacquered stainless steel

1,850 1 1 07090 05 0 C2

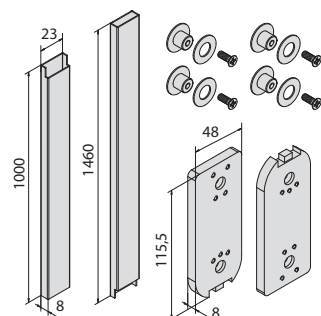

- Glass Kit for additional locking points
- For FAST and Cisa Prestige panic exit devices
- Painted black

2,580 1 1 07090 10 0

- Glass Kit for additional locking points
- For FAST and Cisa Prestige panic exit devices
- satin-finished PVD-treated stainless steel

2,600 1 1 07090 10 0 C2

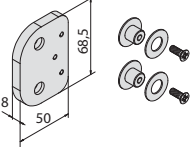
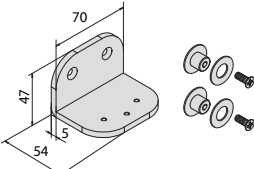
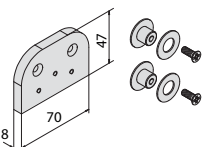
Type	Description	Unit weight Kg	Pieces	ITEM			
				Type	Dim.	Hand	Fin. Pers. Spec.
	<ul style="list-style-type: none"> • Glass Kit for lateral striker • For FAST and Cisa Prestige panic exit devices • Painted black 	0,100	1	1	07091	01	0
	<ul style="list-style-type: none"> • Glass Kit for additional locking points For FAST and Cisa Prestige panic exit devices • satin-finished PVD-treated stainless steel 	0,100	1	1	07091	01	0 C2
	<ul style="list-style-type: none"> • Glass Kit for top striker latch bolt version • For FAST and Cisa Prestige panic exit devices additional locking points • Painted black 	0,100	1	1	07091	02	0
	<ul style="list-style-type: none"> • Glass kit for top striker latch bolt version • For additional locking points for FAST and Cisa Prestige panic exit devices • satin-finished PVD-treated stainless steel 	0,100	1	1	07091	02	0 C2
	<ul style="list-style-type: none"> • Glass Kit for top striker deadbolt version • For FAST and Cisa Prestige panic exit devices additional locking points • Painted black 	0,100	1	1	07091	03	0



Technical features:

- Painted steel bar
- ABS inserts
- Can be shortened up to mm 600 (for Fast Touch) and mm 720 (for eFast)
- LED (120 lumen)
- Bar for FAST Touch rim and mortice panic exit devices and eFAST panic exit devices with LED lights powered by a special 12 V AC transformer.
- Two possible functions: emergency (the lights come on when power fails) and light (the lights are controlled by a switch).

Supplied as standard:

- Steel bar
- LED lights
- Wiring

Finishes:

- Black Fin. 00
- Red Fin. 41
- White RAL 9010 Fin. 45
- Grey Fin. 97
- Green Fin. 43
- Yellow Fin. 42
- Stainless steel grey Fin. 89
- PVD stainless steel Fin. C2



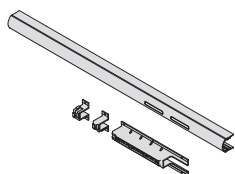

Polaris

Type	Description	For series/item	Kg	Pieces	ITEM			
					Type	Dim.	Hand	Fin.

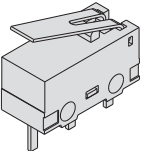

- Polaris kit containing bar, LEDs and wiring components.
- To activate the emergency or light function, CISA Polaris must be connected to a special power supply (not supplied) with the characteristics indicated on the instruction sheet.

1,000 1 1 06196 60 0

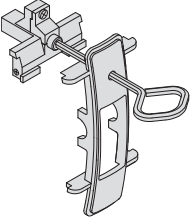
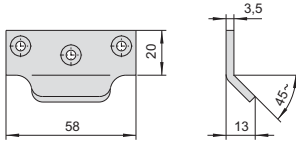
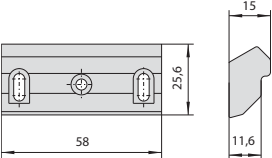
Type	Description	For series/item	Unit weight Kg	Pieces	ITEM				
					Type	Dim.	Hand	Fin.	Pers. Spec.
	<ul style="list-style-type: none"> Microswitch to be used with outside access devices for 1.07078.68/69 version 		0,020	1	1	06195	10	0	
	<ul style="list-style-type: none"> Microswitch to be used with FAST Touch panic exit devices, rim and mortice versions 	59811	0,020	1	1	06195	05	0	
	<ul style="list-style-type: none"> Microswitch to be used with FAST Push panic exit devices, rim version 	59011	0,020	1	1	06195	06	0	
	<ul style="list-style-type: none"> Microswitch to be used with panic exit devices 59607, 59616, 59617 		0,020	1	1	06195	09	0	
	<ul style="list-style-type: none"> Microswitch to be used with panic exit devices series CISA PRESTIGE 		0,036	1	1	06195	07	0	
	<ul style="list-style-type: none"> Hold-open device 	59301, 59311, 59316, 59351, 59361, 59366	0,080	1	1	07065	52	0	
	<ul style="list-style-type: none"> Top and lateral striker with spacers Black painted steel 2x1.5 mm spacer 	59646	0,060	6	1	07072	11	0	
	<ul style="list-style-type: none"> Lateral striker for metal sections Black painted alloy 	07063, 59001, 59801	0,090	6	1	07072	14	0	

Type	Description	For series/item	Unit weight Pieces	ITEM			
				Type	Dim.	Hand	Fin.
	<ul style="list-style-type: none"> • Black painted striker, complete with spacers • Black painted steel 	1 07063 20 0, 1 07063 30 0, 1 07063 35 1, 1 07063 35 2, 1 07063 51 0, 1 07063 61 0, 1 07063 66 1, 1 07063 66 2, 59001, 59016, 59311, 59316, 59801, 59816	0,160	1	1 07072 20 0		
		<ul style="list-style-type: none"> • Top lateral striker complete with spacers • Stainless steel • For stainless steel and C2 finish panic exit devices 	1 07063 20 0, 1 07063 30 0, 1 07063 35 1, 1 07063 35 2, 1 07063 51 0, 1 07063 61 0, 1 07063 66 1, 1 07063 66 2, 59001, 59016, 59311, 59316, 59801, 59816	0,080	1	1 07072 70 0	
	<ul style="list-style-type: none"> • Black painted striker, complete with spacers • Black painted steel 	1 07063 20 0, 1 07063 30 0, 1 07063 35 1, 1 07063 35 2, 1 07063 51 0, 1 07063 61 0, 1 07063 66 1, 1 07063 66 2, 59001, 59016, 59311, 59316, 59801, 59816	0,190	1	1 07072 21 0		
		<ul style="list-style-type: none"> • Lateral and top angle striker complete with spacers • Stainless steel • For stainless steel and C2 finish panic exit devices 	1 07063 20 0, 1 07063 30 0, 1 07063 35 1, 1 07063 35 2, 1 07063 51 0, 1 07063 61 0, 1 07063 66 1, 1 07063 66 2, 59001, 59016, 59311, 59316, 59801, 59816	0,186	1	1 07072 71 0	
	<ul style="list-style-type: none"> • Top/bottom striker • Black painted steel • Stainless steel floor striker 	1 07063 40 0, 1 07063 71 0	0,080	1	1 07072 25 0		
			-	1	1 07072 75 0		
	<ul style="list-style-type: none"> • Black painted striker, complete with spacers • Black painted steel 	1 07063 40 0, 1 07063 71 0	0,080	1	1 07072 26 0		

Type	Description	For series/item	Unit weight Kg	Pieces	ITEM				
					Type	Dim.	Hand	Fin.	Pers.
	<ul style="list-style-type: none"> • Black painted steel floor striker, complete with spacers • Black painted steel 	1 07063 30 0, 1 07063 61 0	0,080	1	1	07072 27 0			
	<ul style="list-style-type: none"> • Top lateral striker complete with spacers • Stainless steel • For stainless steel and C2 finish panic exit devices 	1 07063 31 0, 1 07063 61 0	0,080	1	1	07072 77 0			
	<ul style="list-style-type: none"> • Black painted steel floor striker, complete with spacers • Black painted steel 	1 07063 30 0, 1 07063 61 0	0,126	1	1	07072 28 0			
	<ul style="list-style-type: none"> • Floor striker complete with spacers • Stainless steel • For stainless steel and C2 finish panic exit devices 	1 07063 31 0, 1 07063 61 0	0,124	1	1	07072 78 0			
	<ul style="list-style-type: none"> • Lateral and top strike for PVC door frames • Black nylon 	59300,59315, 59318	0,020	6	1	07072 30 0			
 	<ul style="list-style-type: none"> • Adjustable striker for ALUMINIUM DOORS • ADJUSTMENTS: Coplanarity compensation from -8mm to +4mm • STANDARD SUPPLY Fixing screws • FINISHES: Standard painted black • ON REQUEST: painted WHITE (fin.45) painted GREY (fin.97) 		0,141	6	1	07072 31 0			
	<ul style="list-style-type: none"> • Adjustable striker FOR INDUSTRIAL DOORS • ADJUSTMENTS: Clearance compensation between door wing and frame up to 25 mm Coplanarity compensation from -4 mm to + 7mm • STANDARD SUPPLY Fixing screws • FINISHES: Standard painted black • ON REQUEST: painted WHITE (fin.45) painted GREY (fin.97) 		0,080	6	1	07072 32 0			

Type	Description	For series/item	Unit weight Kg	Pieces 	ITEM				
					Type	Dim.	Hand	Fin.	Peris.

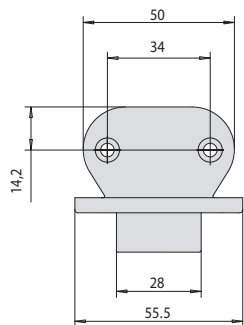

- Adjustable striker for WOOD AND PVC DOORS
- ADJUSTMENTS:
Possible projecting installation on profiles with overlapping sections of 14 mm to 24 mm
- STANDARD SUPPLY
Fixing screws
- FINISHES:
Standard painted black
- ON REQUEST:
painted WHITE (fin.45)
painted GREY (fin.97)

0,080 6 1 07072 33 0

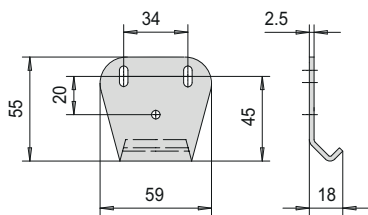
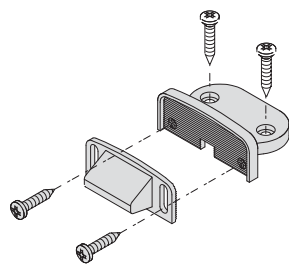

- Lateral and top striker for PVC doors
- Black painted steel

0,080 1 1 07072 34 0

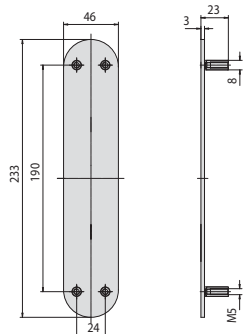

- Outside plate
- Black painted steel
- Outside plate
- satin-finished treated stainless steel

59301,59311, 0,200 1 1 07077 14 0
59316

59351,59361, 0,200 1 1 07077 14 0 C2
59366

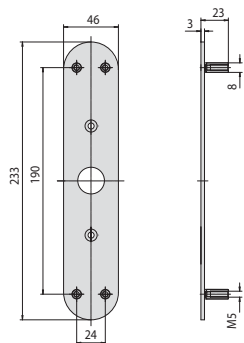

- Outside plate
- Black painted steel
- Outside plate
- satin-finished treated stainless steel

59301,59311, 0,200 1 1 07077 15 0
59316

59351,59361, 0,200 1 1 07077 15 0 C2
59366

Type	Description	For series/item	Unit weight Kg	Pieces	ITEM				
					Type	Dim.	Hand	Fin.	Pers. Spec.
	<ul style="list-style-type: none"> • Closing selector for double doors with door closer • Chrome-plated steel • CE marking in accordance with the regulation 305/2011 • CE mark in compliance with the directive 89/106/CEE issued by ICIM 		0,808	1	1	07084	10	0	
	<ul style="list-style-type: none"> • Closing selector for double doors with door closer • Stainless steel • CE marking in accordance with the regulation 305/2011 • CE mark in compliance with the directive 89/106/CEE issued by ICIM • Voluntary ICIM certification issued by third party as provided for in the same UNI EN 1158 standard 		0,720	1	1	07084	20	0	
	<ul style="list-style-type: none"> • Adjustable closing selector for double doors with door closer • Chrome-plated steel • CE marking in accordance with the regulation 305/2011 • CE mark in compliance with the directive 89/106/CEE issued by ICIM 		0,825	1	1	07084	11	0	
	<ul style="list-style-type: none"> • Adjustable closing selector for double doors with door closer • Stainless steel • CE marking in accordance with the regulation 305/2011 • CE mark in compliance with the directive 89/106/CEE issued by ICIM • Voluntary ICIM certification issued by third party as provided for in the same UNI EN 1158 standard 		0,702	1	1	07084	21	0	
	<ul style="list-style-type: none"> • Spacer 2 mm. • Black nylon 	1 07083 05 0, 1 07083 06 0, 1 07083 07 0, 1 07083 40 0 1 07083 41 0 1 07083 80 0, 1 07083 81 0, 1 07083 82 0, 1 07083 90 0	0,020	1	1	07089	12	0	
	<ul style="list-style-type: none"> • Adapteur for round cylinder • For Cisa Prestige series panic exit devices 	59301, 59311, 59351, 59361	0,030	1	1	07165	21	0	

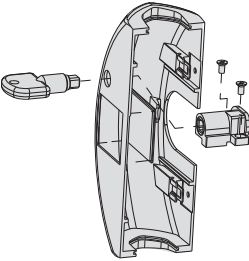
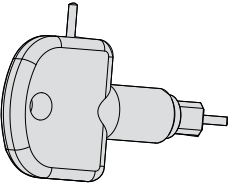
Type	Description	For series/item	 Unit weight Kg	 Pieces	ITEM				
					Type	Dim.	Hand	Fin.	Peris. Spec.
	<ul style="list-style-type: none"> Hold-open device for use with FAST Touch panic exit devices painted GREY (fin. 97) painted WHITE (fin. 45) 	59801, 59811, 59816	0,054	1	1	07165	50	0	
	<ul style="list-style-type: none"> Hold-open device for use with FAST Push panic exit devices painted WHITE (fin. 45) painted GREY (fin. 97) painted STEEL GREY (B9) satin-finished treated stainless steel 	59001, 59011, 59016	0,178	1	1	07165	51	0	
	<ul style="list-style-type: none"> Cover removal tool For all FAST PUSH and FAST TOUCH series 		0,000	1	1	06198	75	0	



SikurExit

Multipoint locking system for emergency exits



Maximum protection against forced entry and quick exit in an emergency

In buildings with heavy human traffic, combining a CISA FAST panic exit device with SikurExit ensures maximum protection against forced entry and guarantees a quick exit in an emergency.

- For single and double aluminium and steel doors
- EN179:2008 and EN1125:2008-certified system
- Grade 6 Security thanks to 3 locking points

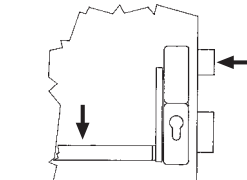
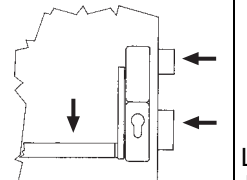
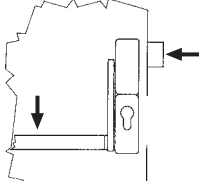
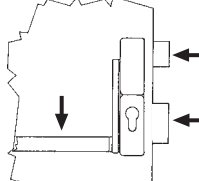
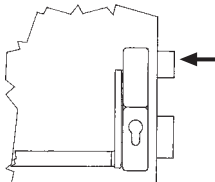
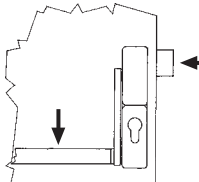
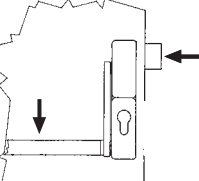
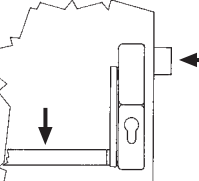

TYPE	CONTROLS	OPERATION	
<p>A</p> <p>OUTSIDE ENTRANCE BY KEY</p> <p>For doors which have to be opened with the key from the outside by authorised personnel only</p>	<p>INSIDE</p> <ul style="list-style-type: none"> - Panic exit device to open. - Key to close with deadbolt. <p>OUTSIDE</p> <ul style="list-style-type: none"> - The key operates latch and deadbolt. 	 <p>1 Outside entrance by key only.</p>	 <p>2</p> <p>Locking with the deadbolt, outside entrance is possible only with the use of the key.</p>
<p>B</p> <p>OUTSIDE HANDLE ACTIVATED OR DISACTIVATED</p> <p>For doors that open outwards and places where it is necessary to provide free entrance.</p>	<p>INSIDE</p> <ul style="list-style-type: none"> - Panic exit device to open. - Key to close with deadbolt and activate or deactivate the outside handle. <p>OUTSIDE</p> <ul style="list-style-type: none"> - The key operates the deadbolt and activates or deactivates the outside handle for latch operation. 	 <p>1</p> <p>The outside handle is activated by rotating the key in the lock-opening direction as far as it will go (the handle remains activated when the key is removed).</p>	 <p>2</p> <p>Closing with the deadbolt deactivates the outside handle; the latter remains deactivated even after the door has been opened with the panic exit device.</p>
<p>C</p> <p>OUTSIDE HANDLE AUTOMATICALLY DISACTIVATED</p> <p>For doors that must be opened from the outside only by authorised persons.</p>	<p>INSIDE</p> <ul style="list-style-type: none"> - Panic exit device to open. - Key to close with deadbolt. <p>OUTSIDE</p> <ul style="list-style-type: none"> - The key operates the throw and activates the handle. 	 <p>1</p> <p>The outside handle is activated by rotating the key in the lock-opening direction as far as it will go, after first withdrawing the deadbolt.</p>	 <p>2</p> <p>Removing the key automatically deactivates the outside handle.</p>
<p>D</p> <p>OUTSIDE HANDLE ALWAYS ACTIVATED</p> <p>For doors that partition throughways (e.g. corridors).</p>	<p>INSIDE</p> <ul style="list-style-type: none"> - Panic exit device to open. - Key to close with deadbolt. <p>OUTSIDE</p> <ul style="list-style-type: none"> - The key operates the deadbolt. The handle, with the deadbolt withdrawn, engages for latch operation. 	 <p>1</p> <p>The outside handle is always activated when the deadbolt is withdrawn.</p>	 <p>2</p> <p>Entry is after using the panic exit device, always possible from the outside as long as the deadbolt is not activated by the key.</p>

Single leaf door

Double leaf door

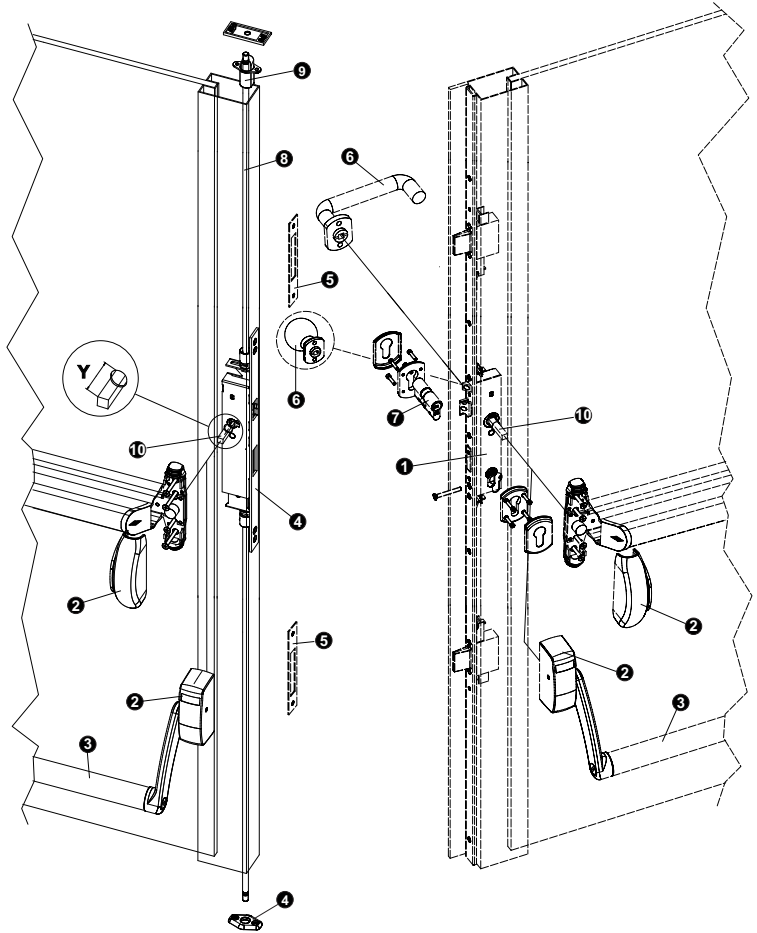
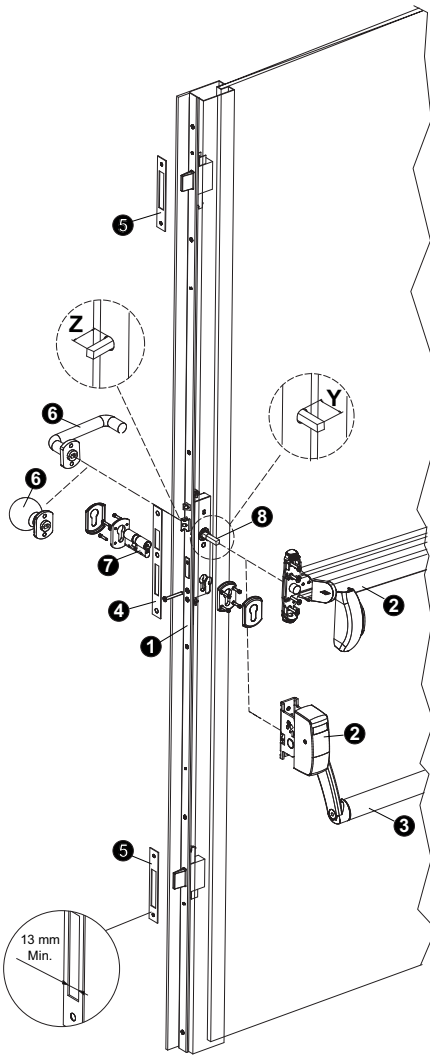

Single leaf door

1	2 EN1125	3	4	5	6	7	8
43725-XX-0 43825-XX-0 43735-XX-0 43835-XX-0	A 59607-10-0	07007-XX-0	06463-14-0 06463-16-0 06463-17-0 06463-31-0	06465-04-0 06465-06-0 06465-07-0 06465-21-0	07070-56-0-B1 07070-66-0-B1	 	07206-00-0
43725-XX-0 43825-XX-0	D		06463-32-0 06463-33-0 06463-34-0	06465-22-0 06465-23-0 06465-24-0	07070-66-0-B1 07070-56-0-B1		
43725-XX-0 43825-XX-0	A		06463-35-0	06465-25-0	07070-56-0-B1		
43735-XX-0 43835-XX-0 43725-XX-0 43825-XX-0	B 59711-00-0 59711-01-0 D		06461-07-0 06461-17-0 06461-30-0 06461-35-0	06461-12-0 06461-22-0 06461-34-0 06461-39-0	07070-66-0-B1 07070-66-0-B1		

Double leaf door

1	2 EN1125	3	4	5	6	7	8	9	10
43725-XX-0 43825-XX-0 43735-XX-0 43835-XX-0	A 59607-10-0	07007-XX-0	43295-XX-0	06465-04-0 06465-06-0 06465-07-0 06465-21-0	07070-56-0-B1 07070-66-0-B1	 	07088-03-0	07089-52-0 06141-80-0	07206-00-0
43725-XX-0 43825-XX-0	D			06465-22-0 06465-23-0 06465-24-0	07070-66-0-B1 07070-56-0-B1				
43725-XX-0 43825-XX-0	A			06465-25-0	07070-56-0-B1				
43735-XX-0 43835-XX-0 43725-XX-0 43825-XX-0	B 59711-00-0 59711-01-0 D			06461-12-0 06461-22-0 06461-34-0 06461-39-0	07070-66-0-B1 07070-66-0-B1				

The Sikurexit system certification is only valid if the components contained in this itemized list are installed (certified system) - applicable standards EN1125 and EN179.

The system certification will no longer be valid if even just one unlisted component is installed:

- Only for the external drives and square spindle: the standard EN1125 is not binding in terms of listed component installation.
- Only for the square spindle: standard EN179 is not binding in terms of listed component installation.



Technical features:

- Steel case with zinc coating
- Top/bottom-adjustable stainless steel faceplate
- Adjustable nickel-plated anti-picking latchbolt and bolt
- Nickel-plated deadbolt
- Square spindle, 8 mm
- DIN holes for handle plate installation

On request:

- European profile cylinder
- Adjustable metal striker
- Cylinder protective rose item 1.06460-05-0
- For panic exit doors (UNI EN 1125) panic exit device series 59607 + bar series 07007 or 59711-00/01
- For emergency exit (UNI EN 179)
- Handle item 1.07070.66.0.B1

- Safety lock series 43295 for double leaf doors
- Electric handle item 1.07074-71-0 (A function only)
- Rose item 1.06473-20/30-0-B1
- Square spindle, 8 mm item 1.07206-00-0 (L=100 mm)
- Electric strikers series 15100, 15200

Standards:

- UNI EN 179
- UNI EN 1125
- Suitable for doors certified to EN 1627:2011 up to WK/RC 4 resistance class
- EN 12209:03 (1 locking point)
- prEN15685:19 (3 locking point)

Hand:
0 = Non-handed

Cylinder to be ordered separately



SikurExit

Type	Description	Spindle hole	Locking points	Throws	Centre Distance	Faceplate	Backset	Unit weight	Pieces	ITEM			
										Type	Dim.	Hand	Fin.

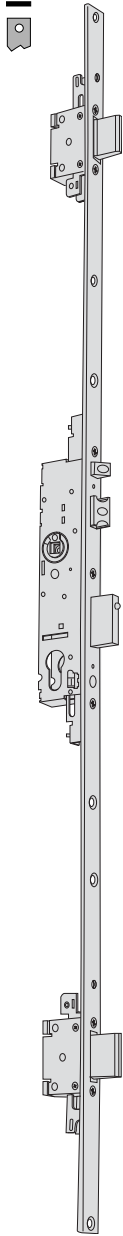

- FOR 1- AND 2-LEAF DOORS
- Stainless steel adjustable flat faceplate, 24x3 mm - height 2,300 mm
 - top adjustment 350 mm
 - bottom adjustment 150 mm
- Adjustable latch bolt (11 to 17 mm) with antipicking system
- 3 lateral deadbolts
- Hold-open device in the version 43725
- Pair of nylon roses item 1.06012-01-0
- Lock, rose and cylinder fixing screws
- Plug for closing the deadbolt hole on 1-leaf door
- Instruction sheet
- 3 certificates

• FUNCTION TYPE A

- Inside:
 - Panic exit device to open
 - Key to close with the deadbolt
- Outside:
 - Key to operate the latch and the deadbolt

• FUNCTION TYPE D

- Inside:
 - Panic exit device to open
 - key to close with the deadbolt
- Outside:
 - Key to close with the deadbolt
 - The handle can operate the latch bolt, with the deadbolt withdrawn

• FUNCTION TYPE B

- Inside:
 - Panic exit device to open
 - Key to close with the deadbolt and enable/disable the outside handle to operate the latch bolt
- Outside:
 - Key to close with the deadbolt and enable/disable the outside handle to operate the latch bolt

TO BE DISCONTINUED Backset 35-40-45

8	3	2	92	24	30	3,440	1	1	43725	30	0
8	3	2	92	24	35	3,440	1	1	43725	35	0
8	3	2	92	24	40	3,440	1	1	43725	40	0
8	3	2	92	24	45	3,440	1	1	43725	45	0

8	3	2	92	24	30	3,440	1	1	43735	30	0
8	3	2	92	24	35	3,440	1	1	43735	35	0
8	3	2	92	24	40	3,440	1	1	43735	40	0
8	3	2	92	24	45	3,440	1	1	43735	45	0

Type	Description	Spindle hole	Locking points	Throws	Centre Distance	Faceplate	Backset	Unit weight Kg	Pieces	ITEM				
										Type	Dim.	Hand	Fin.	Pers. Spec.

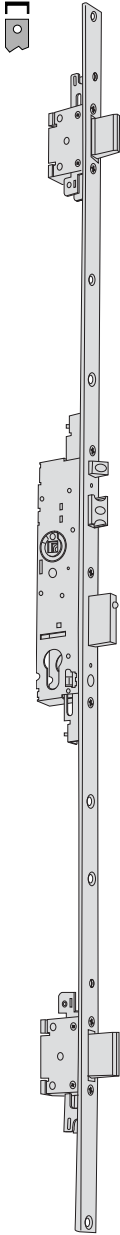

- FOR 1- AND 2-LEAF DOORS
- Stainless steel adjustable flat faceplate, 24x5 mm - height 2,300 mm
 - top adjustment 350 mm
 - bottom adjustment 150 mm
- Adjustable latch bolt (11 to 17 mm) with antipicking system
- 3 lateral deadbolts
- Hold-open device in the version 43825
- Pair of nylon roses item 1.06012-01-0
- Lock, rose and cylinder fixing screws
- Plug for closing the deadbolt hole on 1-leaf door
- Instruction sheet
- 3 certificates

FUNCTION TYPE A

- Inside:
 - Panic exit device to open
 - Key to close with the deadbolt
- Outside:
 - Key to operate the latch and the deadbolt

FUNCTION TYPE D

- Inside:
 - Panic exit device to open
 - key to close with the deadbolt
- Outside:
 - Key to close with the deadbolt
 - The handle can operate the latch bolt, with the deadbolt withdrawn

FUNCTION TYPE B

- Inside:
 - Panic exit device to open
 - Key to close with the deadbolt and enable/disable the outside handle to operate the latch bolt
- Outside:
 - Key to close with the deadbolt and enable/disable the outside handle to operate the latch bolt

TO BE DISCONTINUED Backset 35-40-45

8	3	2	92	24	30	3,440	1	1	43825	30	0			
8	3	2	92	24	35	3,440	1	1	43825	35	0			
8	3	2	92	24	40	3,440	1	1	43825	40	0			
8	3	2	92	24	45	3,440	1	1	43825	45	0			

8	3	2	92	24	30	3,440	1	1	43835	30	0			
8	3	2	92	24	35	3,440	1	1	43835	35	0			
8	3	2	92	24	40	3,440	1	1	43835	40	0			
8	3	2	92	24	45	3,440	1	1	43835	45	0			

Type	Description	Spindle hole	Locking points	Throws	Centre Distance	Faceplate	Backset	Unit weight 	Pieces 	ITEM				
										Type	Dim.	Hand	Fin.	Pers. Spec.



- FOR 1- AND 2-LEAF DOORS
- Stainless steel flat faceplate 24x3 mm
- Adjustable latch bolt (11 to 17 mm) with antipicking system
- 1 lateral deadbolts
- Pair of nylon roses item 1.06012-01-0
- 8 mm nylon spacers (2 3 mm pcs and 1 2 mm pc)
- Fixing screws for lock, roses and cylinder
- Plug for closing the deadbolt hole on 1-leaf door
- Instruction sheet
- 3 certificates

• FUNCTION TYPE A

- Inside:
Panic exit device to open
Key to close with the deadbolt
- Outside:
Key to operate the latch and the deadbolt

FUNCTION TYPE D

- Inside:
Panic exit device to open
key to close with the deadbolt
- Outside:
- Key to close with the deadbolt
-The handle can operate the latch bolt, with the deadbolt withdrawn

• FUNCTION TYPE B

- Inside:
Panic exit device to open
Key to close with the deadbolt and enable/disable the outside handle to operate the latch bolt
- Outside:
Key to close with the deadbolt and enable/disable the outside handle to operate the latch bolt

• FUNCTION TYPE C

- 30/40/45 backsets are replaced by series 43661
- Inside:
Panic exit device to open
Key to close with the deadbolt and enable/disable the outside handle to operate the latch
- Outside:
- Key to close with the deadbolt and enable/disable the outside handle to operate the latch
- The handle is always enabled while the key is in the hole, the handle is disabled when the key is removed

TO BE DISCONTINUED Backset 35-40-45

8	1	2	92	24	30	0,770	1	1	43225 30 0
8	1	2	92	24	35	0,800	1	1	43225 35 0
8	1	2	92	24	40	0,830	1	1	43225 40 0
8	1	2	92	24	45	0,860	1	1	43225 45 0

8	1	2	92	24	30	0,770	1	1	43235 30 0
8	1	2	92	24	35	0,800	1	1	43235 35 0
8	1	2	92	24	40	0,830	1	1	43235 40 0
8	1	2	92	24	45	0,860	1	1	43235 45 0

8	1	2	92	24	35	0,800	1	1	43236 35 0
---	---	---	----	----	----	-------	---	---	------------

Type	Description	Spindle hole	Locking points	Throws	Centre Distance	Faceplate	Backset	Unit weight Kg	Pieces	ITEM				
										Type	Dim.	Hand	Fin.	Pers.

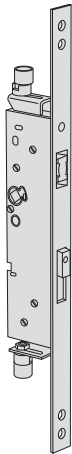

- SECONDARY DOOR SAFETY LOCK FOR USE WITH PANIC FUNCTION MULTIPOINT LOCKS
- A lock series 16605/43725/43735/43835/43225/43235/43236 is installed on the primary door
- Stainless steel faceplate 24x3
- Extension bolt connector adjustable by 20 mm in the horizontal direction
- Deadbolt feeler pin adjustable by 5.5 mm
- Automatic or manual extension bolt closing
- No. 1 5 mm nylon spacer for profiles type "R" and no. 2 3mm nylon spacers for "DOOR" type profiles
- Teflon-coated floor striker item 1.06142.85.0
- Safety lock fixing screws
- Instruction sheet
- FUNCTIONS
- Inside:
 - With panic exit device
- Outside:
 - No operation
- ON REQUEST:
 - Threaded internal extension bolts item 1.07088-03-0
- Fast Push panic exit devices series 59607 + bar series 07007 or Fast Touch panic exit devices item 1.59711.00/01-0
- Automatic device for extension bolt closure restoring item 1.07089.52-0 complete with spacers item 1.06141-81-0 (1 2 mm spacer and 1 2.5 mm spacer) and with top nylon striker item 1.06141-80-0
- Square spindle 8 mm item 1.7206.00.0 (L=100 mm)
- Kit of spacers for safety lock item 1.06141-88-0

8	2	92	24	30	0,875	1	1	43295 30 0
8	2	92	24	40	0,940	1	1	43295 40 0
8	2	92	24	60	1,100	1	1	43295 60 0
8	2	92	24	75	1,100	1	1	43295 75 0

TO BE DISCONTINUED Backset 60-75

Type	Description	For series/item	Unit weight Kg	Pieces	ITEM				
					Type	Dim.	Hand	Fin.	Pers. Spec.

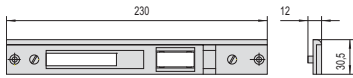

- Lateral adjustment 2,5 mm
- For roller locks use nylon insert item 1.06141.70.0

0,180 12 1 06463 16 0

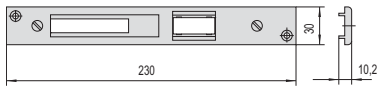
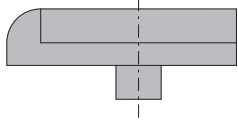

- Lateral adjustment 2,5 mm
- For roller locks use nylon insert item 1.06141.70.0

0,170 12 1 06463 17 0

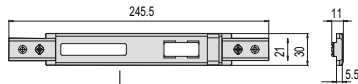
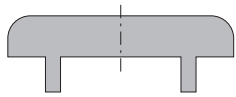

- Lateral adjustment 8 mm
- For roller locks use nylon insert item 1.06141.71.0
- PROFILES: R40, R50TT, NEW TEC 52 SOR TT, etc.

0,230 12 1 06463 31 0

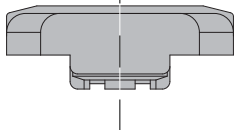

- ON REQUEST:
nickel-plated (fin. 12)

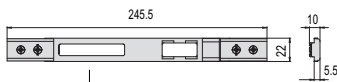

- REPLACES ITEM 1.06463.18.0
- Lateral adjustment 4 mm
- Central part in lacquered steel
- For roller locks use nylon insert item 1.06141.71.0

0,145 12 1 06463 32 0

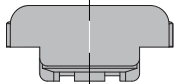

- IDEM
- Central part in stainless steel

0,141 12 1 06463 33 0

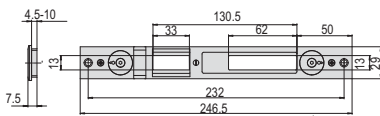

- REPLACING ITEM 1.06463.34.0
- Painted black
- Lateral adjustment 2.5 mm
- For roller locks, use nylon insert item 1.06141.70.0

19000, 49000, 0,187 12 1 06463 84 0
43200, 43700,
43800, 4A000
4A010, 4A100
4A120, 4A200
4A210

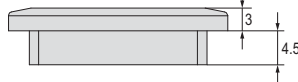

- REPLACING ITEM 1.06463.35.0
- IDEM
- Central part in stainless steel

19000, 49000, 0,158 12 1 06463 85 0
43200, 43700,
43800, 4A000
4A010, 4A100
4A120, 4A200
4A210

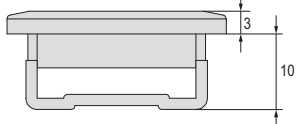

Type	Description	For series/item	Unit weight Kg	Pieces	ITEM				
					Type	Dim.	Hand	Fin.	Pers.
	<ul style="list-style-type: none"> • Lateral adjustment 2,5 mm • For roller locks use nylon insert item 1.06141.70.0 		0,122	12	1	06465	06	0	
	<ul style="list-style-type: none"> • Lateral adjustment 2,5 mm • For roller locks use nylon insert item 1.06141.70.0 		0,117	12	1	06465	07	0	
	<ul style="list-style-type: none"> • Lateral adjustment 8 mm • For roller locks use nylon insert item 1.06141.71.0 • PROFILES: R40, R50TT, NEW TEC 52 SOR TT, etc. • ON REQUEST: nickel-plated (fin. 12) 		0,140	12	1	06465	21	0	
	<ul style="list-style-type: none"> • REPLACES ITEM 1.06465.02.0 • Lateral adjustment 4 mm • Central part in lacquered steel • For roller locks use nylon insert item 1.06141.71.0 		0,112	12	1	06465	22	0	
	<ul style="list-style-type: none"> • IDEM • Central part in stainless steel 		0,112	12	1	06465	23	0	
	<ul style="list-style-type: none"> • REPLACING ITEM 1.06463.04.0 • Lateral adjustment 2.5 mm • 4.5 to 10 mm adjustable thickness. • For roller locks, use nylon insert item 1.06141.70.0 	1 06443 00 0, 1 06443 05 0, 1 06453 05 0, 19000, 43700, 43800, 46200, 46210, 46220, 46420, 46520, 49000, 17300, 56300, 57300, 43700, 43800	0,125	12	1	06465	24	0	
	<ul style="list-style-type: none"> • AS ABOVE • Stainless steel 		0,112	12	1	06465	25	0	



Technical features:

- Steel case with zinc coating
- Stainless steel faceplate
- Latchbolt, nickel-plated steel
- Reversible latch/bolt
- Square spindle, 8 mm
- CE 12V AC voltage
- Absorbed current 3.1 A

Supplied as standard:

- Set of faceplate spacers item 1.06141.65.0
- Fixing screws lock and cylinder
- Instruction sheet

On request:

- Special striker plates (see Vademecum)
- Cylinder protective rose item 1.06460.00.0
- Mechanical control button item 1.06110.15.0
- Safety lock series 43295 for double leaf doors

Standards:

- UNI EN 179
- UNI EN 1125
- EN 12209:03 and EN 14846:08

Hand:
0 = Non-handed

Cylinder to be ordered separately



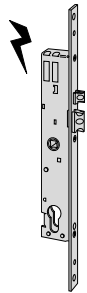

Type	Description	Fin.	Spindle hole	Locking points	Throws	Centre Distance	Faceplate	Backset	Unit weight 	Pieces 	ITEM			
											Type	Dim.	Hand	Fin.



- For panic doors
- 10.5 to 16.5 mm adjustable latch and deadbolt
- Pair of nylon roses item 1.06012.01.0
- Use with panic exit devices in compliance with EN 1125:
 - 59607.10.0
 - 59711.00/01.0
- Use with handle in compliance with EN 179:
 - 07070.66.0.B1

-	85	22	25	0,764	1	1	16605	25	0					
-	85	22	30	0,788	1	1	16605	30	0					
-	85	22	35	0,833	1	1	16605	35	0					





Technical features:

- Steel case and cover.
- Nickel-plated steel deadbolts.
- Nickel-plated steel non-handed latch.
- Anti-crush plates for screw fixing.
- Steel active pins.
- 1 pc or 5 pcs packages (industrial packaging)

Supplied as standard:

- Striker plate series 06220.

On request:

- Cylinder protective roses series 06460; 06480; 06485.
- Inside escutcheons series 06473.
- Electric strikerst series 15300

For additional locking points
 Divertor item series 06433.00/01/11
 Pair of bolts item 06425.06.0
 Striker plates item 06220.28/29.0

For panic exit doors (UNI EN 1125) panic exit device series 59607 + bar series 07007 or 59711-10/11

For emergency exits (UNI EN 179)
 Handle item 1.07070.50.0
 Pair of handles item 1.07070.60.0

Finishes:

- Zinc aluminum.

Standards:

- UNI EN 179
- UNI EN 1125
- UNI EN 12209

Hand:
 0 = Non-handed

Cylinder to be ordered separately



Type	Description	DEAD-BOLTS								ITEM			
		No.	Projection	Centre Distance	Throws	Centre Distance	Faceplate	Backset	Unit weight Kg	Pieces	Type	Dim. Hand	Fin.

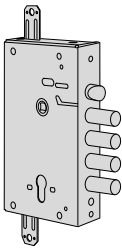

- Deadbolt and latch
- Pre-set for additional locking points
- **FUNCTION TYPE B**
- Inside:
Panic exit device and/or handle to open
Key to close with deadbolt and enable or disable the outside handle when latch is operated
- Outside:
Key to close with deadbolt and enable or disable the outside handle when latch is operated

4	3,5	27	2	85	64	2,650	1	1	56916 27 0
4	3,5	28	2	85	64	2,650	1	1	56916 28 0
3	3,5	38	2	85	64	2,650	1	1	56916 38 0
4	3,5	28	2	85	64	2,550	5	1	56916 48 0
3	3,5	38	2	85	64	2,550	5	1	56916 58 0

- **FUNCTION TYPE D**
- Inside:
The panic exit device and/or the handle to open
The key to close with the deadbolt
- Outside:
The key to close with the deadbolt. When the deadbolt is withdrawn, the handle is activated and can operate the latch

4	3,5	28	2	85	64	2,650	1	1	56917 28 0
3	3,5	38	2	85	64	2,650	1	1	56917 38 0
4	3,5	28	2	85	64	2,550	5	1	56917 48 0
3	3,5	38	2	85	64	2,550	5	1	56917 58 0



Technical features:

- Steel case and cover.
- Nickel-plated steel faceplate
- Nickel-plated steel deadbolts.
- Nickel-plated steel non-handed latch.
- Anti-crush plates for screw fixing.
- Steel active pins.
- 1 pc or 5 pcs packages (industrial packaging)

Supplied as standard:

- Striker plate series 06220.

On request:

- Cylinder protective roses series 06460; 06480; 06485.
- Inside escutcheons series 06473.
- Electric strikerst series 15300

- For additional locking points
Divertor item series 06433.00/01/11
Pair of bolts item 06425.06.0
Striker plates item 06220.28/29.0
- For panic exit doors (UNI EN 1125) panic exit device series 59607 + bar series 07007 or 59711-10/11
- For emergency exits (UNI EN 179)
Handle item 1.07070.50.0
Pair of handles item 1.07070.60.0

Hand:
0 = Non-handed

Cylinder to be ordered separately



Finishes:

- Zinc aluminum.

Standards:

- UNI EN 179
- UNI EN 1125
- UNI EN 12209

Exitlock

Type	Description	DEADBOLTS								ITEM			
		No.	Projection	Centre Distance	Throws	Centre Distance	Faceplate	Backset	Unit weight	Pieces	Type	Dim. Hand	Fin.

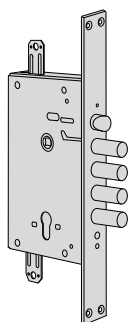

- Deadbolt and latch
- Pre-setting for additional locking points

• FUNCTION TYPE B

- Inside:
Panic exit device and/or handle to open
Key to close with deadbolt and enable or disable the outside handle when latch is operated
- Outside:
Key to close with deadbolt and enable or disable the outside handle when latch is operated

4	28	2	85	35	67	2,800	1	1	56936	28	0		
4	28	2	85	35	67	2,650	5	1	56936	48	0		

• FUNCTION TYPE D

- Inside:
The panic exit device and/or the handle to open
The key to close with the deadbolt
- Outside:
The key to close with the deadbolt. When the deadbolt is withdrawn, the handle is activated and can operate the latch

4	28	2	85	35	67	2,800	1	1	56937	28	0		
4	28	2	85	35	67	2,650	5	1	56937	48	0		



Technical features:

- Laquered polished brass removable faceplate and striker
- Zinc-plated steel case
- Reversible, nickel-plated silent action latch
- Nickel-plated bolt for latch dead-locking (if provided)
- Nickel-plated cut-resistant deadbolt, with a 25 mm. protrusion
- Anti-corrosion galvanised internal components

Supplied as standard:

- Striker
- Fixing screws
- Instruction sheet

On request:

- Satin stainless steel faceplate and striker (fin 20)

- For panic exit doors (UNI EN 1125) panic exit device series 59607 + bar series 07007 or 59711-00/01
- For emergency exit (UNI EN 179)
- Handle series 30200

Standards:

- Locks with satin stainless steel faceplate and striker (finish 20), are certified fire-resistant by the American Underwrite Laboratories UL LISTED R 14945(N)
- CE marking in accordance with the regulation n° 305/2011
- Only for A.I.S version (finish 20) CE mark according to the 89/106/EEC DIRECTIVE granted by ICIM
- Standard reference:
 - UNI EN 179
 - UNI EN 1125
 - UNI EN 12209

Hand:
0 = Non-handed

Cylinder to be ordered separately



Type	Description	Throws	Centre Distance	Faceplate Backset	Kg	Pieces	ITEM				
							Type	Dim. Hand	Fin.	Pers.	Spec.

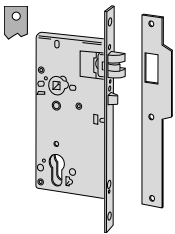

- **FUNCTION TYPE B:**
- Latch only with antipicking device
- Split square spindle
- Reversible panic function
- The outside handle can be deactivated with the key
- Outside: the latch can be operated with the handle, the key activates/deactivates the handle
- Inside: the latch can be operated with the handle or the panic exit device, the key activates/deactivates the outside handle
- Note: when the door is opened from the inside with the handle or the panic exit device, the outside handle remains deactivated after the door is closed (in stand-by)

85	22	60	0,900	1	1	52760 60 0
85	22	70	0,950	1	1	52760 70 0
85	22	90	1,050	1	1	52760 90 0

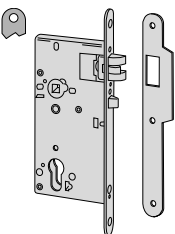

- **FUNCTION TYPE B:**
- Latch only with antipicking device
- Split square spindle
- Reversible panic function
- The outside handle can be deactivated with the key
- Outside: the latch can be operated with the handle, the key activates/deactivates the handle
- Inside: the latch can be operated with the handle or panic exit device, the key activates/deactivates the outside handle
- Note: when the door is opened from the inside with the handle or the panic exit device, the outside handle remains deactivated after the door is closed (in stand-by)

85	22	60	0,900	1	1	52761 60 0
85	22	70	0,950	1	1	52761 70 0
85	22	80	1,000	1	1	52761 80 0
85	22	90	1,050	1	1	52761 90 0

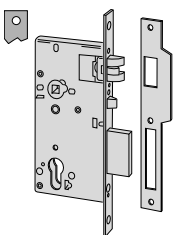

- **FUNCTION TYPE A:**
- Through square spindle
- The deadbolt is automatically released when closing the door
- Outside: latch and deadbolt are operated only with the key
- Inside: latch and deadbolt are operated with the key, the handle or the panic exit device

1	85	22	60	0,950	1	1	52840 60 0
1	85	22	70	1,000	1	1	52840 70 0
1	85	22	80	1,050	1	1	52840 80 0
1	85	22	90	1,100	1	1	52840 90 0

Type	Description	Throws	Centre Distance	Faceplate	Backset	Unit weight 	Pieces 	ITEM				
								Type	Dim.	Hand	Fin.	Pers. Spec.
	<ul style="list-style-type: none"> • FUNCTION TYPE A: • Through square spindle • The deadbolt is automatically released when closing the the door • Outside: latch and deadbolt are operated only with the key • Inside: latch and deadbolt are operated with the key, the handle or the panic exit device 	1	85	22	60	0,950	1	1	52860	60	0	
		1	85	22	70	1,000	1	1	52860	70	0	
		1	85	22	80	1,050	1	1	52860	80	0	
		1	85	22	90	1,100	1	1	52860	90	0	
	<ul style="list-style-type: none"> • FUNCTION TYPE A: • Latch and deadbolt with antipicking device • Through square spindle • Outside: latch and deadbolt are operated only with the key • Inside: latch and deadbolt are operated with the key, the handle or the panic exit device 	1	85	22	60	0,950	1	1	52842	60	0	
		1	85	22	70	1,000	1	1	52842	70	0	
		1	85	22	80	1,050	1	1	52842	80	0	
		1	85	22	90	1,100	1	1	52842	90	0	
	<ul style="list-style-type: none"> • FUNCTION TYPE A: • Latch and deadbolt with antipicking device • Through square spindle • Outside: latch and deadbolt are operated only with the key • Inside: latch and deadbolt are operated with the key, the handle or the panic exit device 	1	85	22	60	0,950	1	1	52862	60	0	
		1	85	22	70	1,000	1	1	52862	70	0	
		1	85	22	80	1,050	1	1	52862	80	0	
		1	85	22	90	1,100	1	1	52862	90	0	
	<ul style="list-style-type: none"> • FUNCTION TYPE D: • Split square spindle • Reversible panic function • Outside:the latch can be operated with the handle • Inside: latch and deadbolt are operated with the handle or the panic exit device • The key operates only the deadbolt from either side • Note: when the door is opened from the inside with the handle or the panic exit device, the deadbolt remains withdrawn after closing the door and the outside handle remains activated and can withdraw the latch (door open) 	1	85	22	60	0,950	1	1	52844	60	0	
		1	85	22	70	1,000	1	1	52844	70	0	
		1	85	22	80	1,050	1	1	52844	80	0	
		1	85	22	90	1,100	1	1	52844	90	0	
	<ul style="list-style-type: none"> • FUNCTION TYPE D: • Split square spindle • Reversible panic function • Outside:the latch can be operated with the handle • Inside: latch and deadbolt are operated with the handle or the panic exit device • The key operates only the deadbolt from either side • Note: when the door is opened from the inside with the handle or the panic exit device, the deadbolt remains withdrawn after closing the door and the outside handle remains activated and can withdraw the latch (door open) 	1	85	22	60	0,950	1	1	52864	60	0	
		1	85	22	70	1,000	1	1	52864	70	0	
		1	85	22	80	1,050	1	1	52864	80	0	
		1	85	22	90	1,100	1	1	52864	90	0	



Technical features:

- Satin lacquered brass faceplate and striker
- Semi-matt black lacquered steel case
- Reversible, nickel-plated latch
- Nickel-plated, antipicking bolt (if provided)
- Nickel-plated deadbolt
- Can be fitted with: escutcheons, roses, handle plates and through screws
- Through-spindle

Supplied as standard:

- Striker
- Striker and cylinder fixing screws

On request:

- Satin lacquered chrome-plated finish (fin. 18)
- For panic exit doors (UNI EN 1125) panic exit device series 59607 + bar series 07007 or 59711-00/01
- For emergency exit (UNI EN 179) Handle series 30200

Standards:

- Standard reference
UNI EN 179
UNI EN 1129
UNI EN 12209

Hand:
0 = Non-handed

Cylinder to be ordered separately



Type	Description	Throws	Centre Distance	Faceplate	Backset	Unit weight 	Pieces 	ITEM			
								Type	Dim.	Hand	Fin.

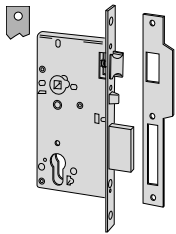

- FUNCTION TYPE A:
- Deadbolt and dead-locking latch
- SUPPLIED AS STANDARD:
striker item 1.06106.01.0
- ON REQUEST:
Faceplate 18x240 (spec. AG)
Without antipicking bolt (suffix AF)

1	85	22	40	0,720	1	1	52810 40 1				
1	85	22	40	0,720	1	1	52810 40 2				
1	85	22	45	0,760	1	1	52810 45 0				
1	85	22	50	0,780	1	1	52810 50 0				
1	85	22	60	0,840	1	1	52810 60 0				
1	85	22	70	0,920	1	1	52810 70 0				

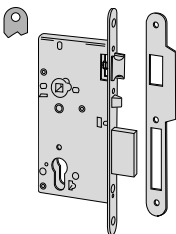

- FUNCTION TYPE A:
- Deadbolt and dead-locking latch
- SUPPLIED AS STANDARD:
striker item 1.06106.05.0
- ON REQUEST:
Faceplate 18x240 (spec. AG)
Without antipicking bolt (suffix AF)

1	85	22	40	0,720	1	1	52830 40 1				
1	85	22	40	0,720	1	1	52830 40 2				
1	85	22	45	0,760	1	1	52830 45 0				
1	85	22	50	0,780	1	1	52830 50 0				
1	85	22	60	0,840	1	1	52830 60 0				
1	85	22	70	0,920	1	1	52830 70 0				



- Technical features:**
- Painted aluminium body and bar
 - Painted aluminum alloy cover
 - Adjustable length up to 300 mm
 - Galvanized steel internal components suitable for fire doors

- Supplied as standard:**
- Fixing screws
 - ICIM and CE certificates of compliance
 - Installation and maintenance Instructions

- On request:**
- Internal and external plates
 - Version with microswitch (spec. LA)
 - Fire door version (FR spec.).

- Standards:**
- Cover: black bar: red
 - ON REQUEST (only item 1.59711-00/10-0):
 - Cover: black bar: black (fin. 44)
 - Cover: white bar: white (fin. 45)
 - Cover: gray bar: grey (fin. 97)
 - Carter and bar painted steel grey (fin. B9)
 - PVD treatment: satin-finished stainless steel (fin. C2)

- Certifications:**
- CE marking in accordance with the regulation n° 305/2011

Hand:
0 = Non-handed

FAST Touch



Type	Description	Spindle hole	L	Unit weight 	Pieces 	ITEM			
						Type	Dim.	Hand	Fin.

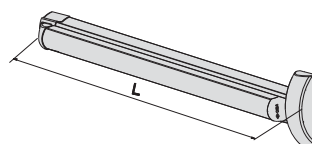

- Can be combined with panic function locks series Sikurexit, Heavy Duty and 52810, 52830, 43100

8/9	1200	3,366	1	1 59711 00 0
8/9	840	2,592	1	1 59711 01 0
8/9	1300	3,750	1	1 59711 06 0

- satin-finished PVD-treated stainless steel

8/9	1200	3,366	1	1 59711 00 0 C2
8/9	1300	3,750	1	1 59711 06 0 C2

- Can be combined with panic function locks series Exitlock and Sicur Panic

8/9	1200	3,360	1	1 59711 10 0
8/9	840	2,592	1	1 59711 11 0
8/9	1300	3,750	1	1 59711 16 0

- satin-finished PVD-treated stainless steel

8/9	1200	3,366	1	1 59711 10 0 C2
8/9	1300	3,750	1	1 59711 16 0 C2

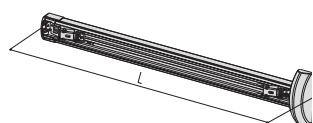

- SUPPLIED WITHOUT PUSH BAR VERSION
- Can be combined with panic function locks series Sikurexit, Heavy Duty and 52810, 52830, 43100

8/9	1200	2,366	1	1 59711 00 0 00 SB
8/9	1300	2,566	1	1 59711 06 0 00 SB

- Can be combined with panic function locks series Exitlock and Sicur Panic

8/9	1200	2,360	1	1 59711 10 0 00 SB
8/9	1300	2,560	1	1 59711 16 0 00 SB

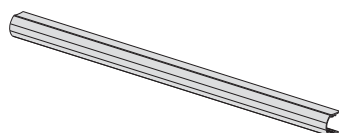

- Bar may be combined with panic exit devices series 1.59711.00/10.0.00.SB series 1.59711.06/16.0.00.SB
- STANDARD FINISHES
Black (fin. 00)
- BAR COLOR OPTIONS:
satin-finished anodised aluminium (fin. 62)
Anodised bronze (fin. 64)
Brass-plated (fin. A1)
Red (fin. 41)
Green (fin. 43)
White (fin. 45)
Grey (fin. 97)

1,000	1	1 06196 43 0
1,200	1	1 06196 45 0



Technical features:

- Painted aluminum alloy/aluminum cover (59607 serie)
- Galvanized steel internal components suitable for fire doors

Supplied as standard:

- Fixing screws
- ICIM and CE certificates of compliance
- Installation and maintenance Instructions

On request:

- Internal and external plates
- Version with microswitch (spec. LA)
- Fire door version (FR spec.).

Finishes:

- STANDARD: Painted black
- ON REQUEST: Painted white (fin. 45)
Painted gray (fin. 97)
Painted steel grey (fin. B9)
PVD treatment: satin-finished stainless steel (fin. C2)

Standards:

- CE marking in compliance with the Construction Products Regulation 305/2011 issued by ICIM

Hand:
0 = Non-handed

Bar to be ordered separately



series 07007

FAST Push

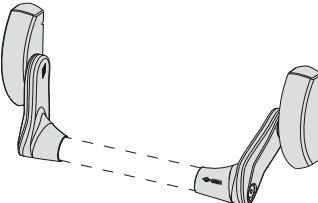
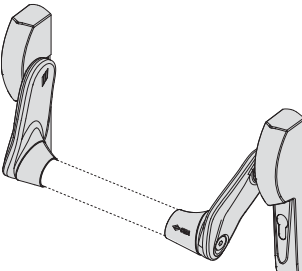
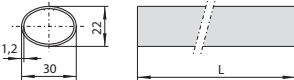
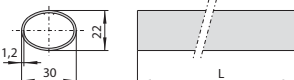

Type	Description	Spindle hole L	Kg Unit weight	Pieces	ITEM				
					Type	Dim.	Hand	Fin.	Pers.
	<ul style="list-style-type: none"> • Can be combined with panic function locks • satin-finished PVD-treated stainless steel 	8/9	1,900	1	1	59607	10	0	
		8/9	1,650	1	1	59607	10	0	C2
	<ul style="list-style-type: none"> • Black nylon casing • Can be combined with panic function locks centre distance 92 • Can be combined with panic function locks centre distance 72 	8/9	1,820	1	1	59617	12	0	
		8/9	1,820	1	1	59617	00	0	
	<ul style="list-style-type: none"> • Red painted steel oval shaped bar • AVAILABLE FINISHES (extra price): yellow painted (fin. 42) green painted (fin. 43) black painted (fin. 44) white painted (fin. 45) grey painted (fin. 97) painted steel grey (fin. B9 only version .13 e .14) 	900	0,800	1	1	07007	13	0	
		1200	1,054	1	1	07007	14	0	
		1500	1,440	1	1	07007	15	0	
	<ul style="list-style-type: none"> • Stainless steel oval shaped horizontal bar 	900	0,800	1	1	07007	60	0	
		1200	1,070	1	1	07007	61	0	
		1500	1,400	1	1	07007	62	0	



Technical features:

- Non-handed handle.
- Idle handle under no power input conditions.
- Key operated mechanical emergency system: the key will operate the handle.
By removing the key the handle will be deactivated.
- Wiring system with connector for complete connection insulation.
- LED integral with handle body for door status visual indication.
- Nickel-plated steel case.
- Painted aluminum alloy cover.
- Electric hold-open device available.
- Power input through supplied Booster device.
- Rated voltage 12/24 V ac/dc.
- Operating voltage min. 5 V, max 28 V.

Supplied as standard:

- 8/9 mm square spindle.

On request:

- European profile cylinder.
- Timer item 1.07022.20.0.

Finishes:

- Black painted (RAL 9005).
- Grey painted (RAL 9006).

Hand:

0 = Non-handed

Type	Description	Faceplate	Unit weight 	Pieces 	ITEM				
					Type	Dim.	Hand	Fin.	Pers. Spec.

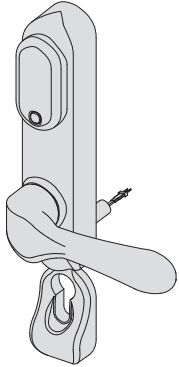

- Electrically enabled handle (A function only)
- Can be installed with locks series 43225, 43250, 43725, 43825, 52840, 52860, 52842, 52862, 52810, 52830, 56917, 56937
- Handle to cylinder distance 92 mm
- **STANDARD SUPPLY:**
Connecting cable
Fixing screws
- **ON REQUEST:**
Timer device 07022.20.0

1,150 1 1 07074 71 0

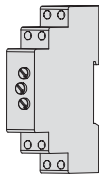

- Multiple scale timer

0,100 1 1 07022 20 0

Type	Description	For series/item	Unit weight Kg	Pieces	ITEM			
					Type	Dim.	Hand	Fin.
	<ul style="list-style-type: none"> • Nylon cover for thermal cut profiles • For outward opening doors 	1 06141 40 0, 1 06285 36 0, 1 06463 24 0, 1 06463 25 0, 1 06463 34 0, 1 06463 35 0, 1 06465 24 0, 1 06465 25 0,	0,019	25	1	06141	79	0
	<ul style="list-style-type: none"> • Upper striker for extension bolt • Black nylon 	1 07089 52 0	0,022	25	1	06141	80	0
	<ul style="list-style-type: none"> • Nylon faceplate spacer 	43295	0,020	12	1	06141	88	0
	<ul style="list-style-type: none"> • Nylon cover for thermal cut aluminium profiles for outward opening doors (lip height from 3 to 7.5 mm) 	1 06463 24 0, 1 06463 25 0, 1 06463 34 0, 1 06463 35 0, 1 06465 24 0, 1 06465 25 0	0,019	25	1	06141	89	0
	<ul style="list-style-type: none"> • Pair of floor strikers 		0,060	12	1	06142	85	0
	<ul style="list-style-type: none"> • Stainless steel flat striker 24 x 1.5 mm. 		0,053	12	1	06461	07	0

Type	Description	For series/item	Unit weight Pieces	ITEM			
				Type	Dim.	Hand	Fin. Pers. Spec.
	<ul style="list-style-type: none"> Stainless steel flat striker 24 x 1.5 mm. 		0,034 12	1	06461	12	0
	<ul style="list-style-type: none"> Stainless steel flat striker 36x2 mm for FORSTER "UNICO" 		0,080 12	1	06461	17	0
	<ul style="list-style-type: none"> Stainless steel flat striker 36x2 mm for FORSTER "UNICO" 		0,046 12	1	06461	22	0
	<ul style="list-style-type: none"> Stainless steel flat striker 24 x 3 mm 		0,093 12	1	06461	30	0
	<ul style="list-style-type: none"> Stainless steel flat striker 24 x 3 mm 		0,065 12	1	06461	34	0
	<ul style="list-style-type: none"> Stainless steel U-shaped striker 24 x 6 mm. 		0,098 12	1	06461	35	0
	<ul style="list-style-type: none"> Stainless steel U-shaped striker 24 x 6 mm. 		0,065 12	1	06461	39	0
	<ul style="list-style-type: none"> Thumb turn to install with SikurExit Finishes: nickel-plated, chrome-plated and satin-finished For EN 179:2008 the handle item 1.07070.66.0.B1 should also be ordered 	43225, 43235, 43236, 43295, 43725, 43735, 43825, 43835	0,200 1	1	07070	56	0 B1
	<ul style="list-style-type: none"> Handle to install with SikurExit Finishes: nickel-plated, chrome-plated and satin-finished For EN 179:2008 2 pieces should be ordered 	43225, 43235, 43236, 43295, 43725, 43735, 43825, 43835	0,400 1	1	07070	66	0 B1

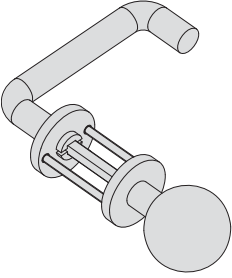
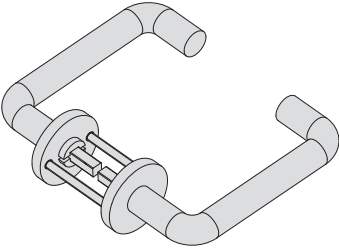
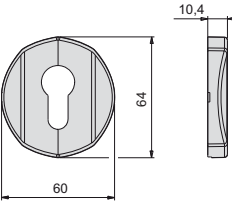
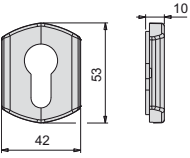
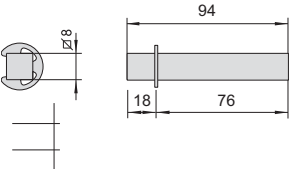
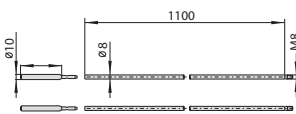
Type	Description	For series/item	Unit weight Kg	Pieces	ITEM				
					Type	Dim.	Hand	Fin.	Pers. Spec.
	<ul style="list-style-type: none"> • Handle and fixed thumb turn to install with Exit lock • AVAILABLE FINISHES: Anodised bronze (fin. 00) satin-finished nickel-plated chrome (fin. B1) 	56915, 56935	0,400	1	1	07070	50	0	
	<ul style="list-style-type: none"> • Pair of handles to install with Exit lock • AVAILABLE FINISHES: Anodised bronze (fin. 00) satin-finished nickel-plated chrome (fin. B1) 	56916, 56917, 56936, 56937	0,400	1	1	07070	60	0	
	<ul style="list-style-type: none"> • Black painted inside plate • Can be installed with panic exit devices • To be combined with European profile cylinder protective roses on armoured doors • FINISHES ON REQUEST: painted white (fig. 45) painted grey (fin. 97) 		0,106	6	1	07076	70	0	
	<ul style="list-style-type: none"> • satin-finished PVD-treated stainless steel 		0,106	6	1	07076	70	0 C2	
	<ul style="list-style-type: none"> • Black painted inside plate • Can be installed with mortice version panic exit devices • To be combined with European profile cylinder protective roses on armoured doors • FINISHES ON REQUEST: painted white (fig. 45) painted grey (fin. 97) 		0,106	6	1	07076	71	0	
	<ul style="list-style-type: none"> • satin-finished PVD-treated stainless steel 		0,106	6	1	07076	71	0 C2	
	<ul style="list-style-type: none"> • Steel split splindle 		0,100	1	1	07085	77	0	
	<ul style="list-style-type: none"> • Zinc plated extension bolts • SUPPLIED AS STANDARD: Pair of bolts diameter 8 mm. Hardened steel tip diameter 10 mm. item 1.06291.05.0 (Pcs. 2) 		0,600	12	1	07088	03	0	

Type	Description	For series/item	Unit weight Kg	Pieces	ITEM				
					Type	Dim.	Hand	Fin.	Peris. Spec.

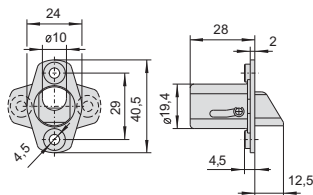

- Steel dogging device, complete with:
Spacers item 1.06141.81.0
Upper striker item 1.06141.80.0

43295 0,060 1 1 07089 52 0

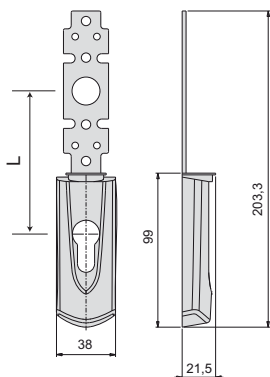

- Black painted outside plate
- Can be installed with Fast Touch panic exit devices series 59711
- FINISHES ON REQUEST:
painted white (fin. 45)
painted grey (fin. 97)
L=72 (dim. 61)
L=85 (dim. 62)
L=92 (dim. 63)

0,110 6 1 07176 61 0

0,110 6 1 07176 62 0

0,110 6 1 07176 63 0

- satin-finished PVD-treated stainless steel

0,110 6 1 07176 61 0 C2

0,110 6 1 07176 62 0 C2

0,110 6 1 07176 63 0 C2

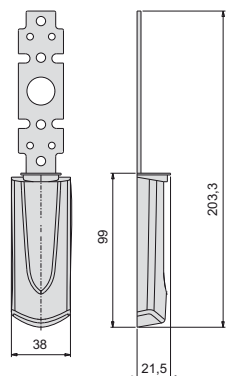

- Black painted outside plate
- Can be installed with Fast Touch panic exit devices series 59711
- FINISHES ON REQUEST:
painted white (fin. 45)
painted grey (fin. 97)

0,110 6 1 07176 66 0

- satin-finished PVD-treated stainless steel

0,110 6 1 07176 66 0 C2



- Steel split splindle

0,050 6 1 07206 00 0

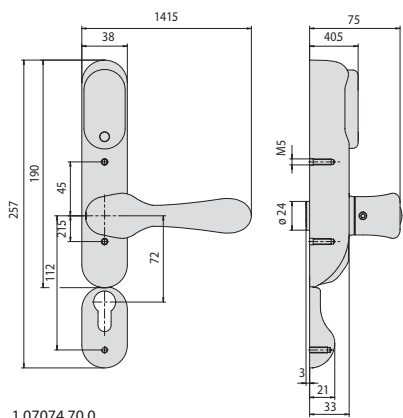

1.07074.70.0

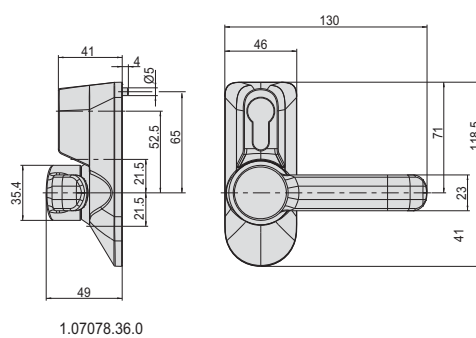

1.07078.36.0

1

4

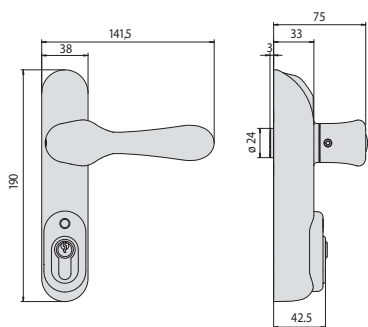

1.07074.80.0

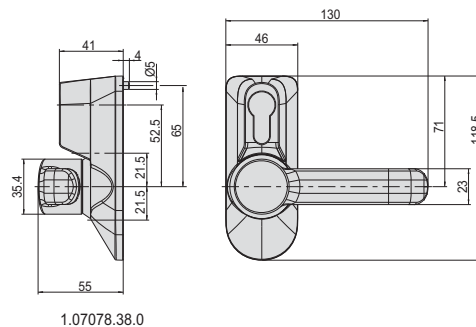

1.07078.38.0

2

5

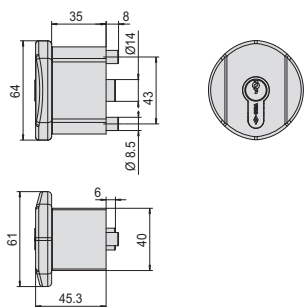

1.07078.35.0

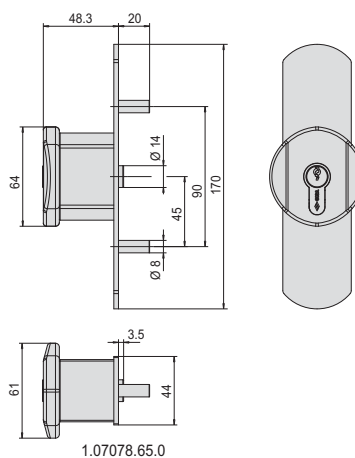

1.07078.65.0

3

6

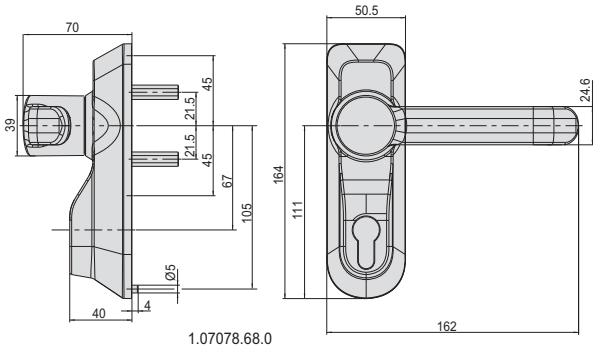

1.07078.68.0

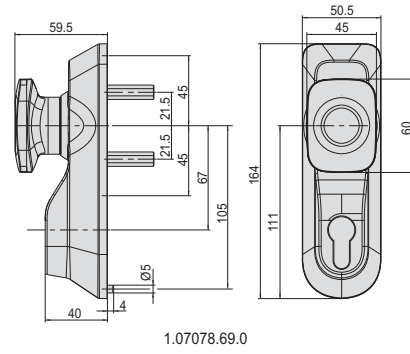

1.07078.69.0

8

7

1.07083.05/06/07/40/41/80/81/82/90

9

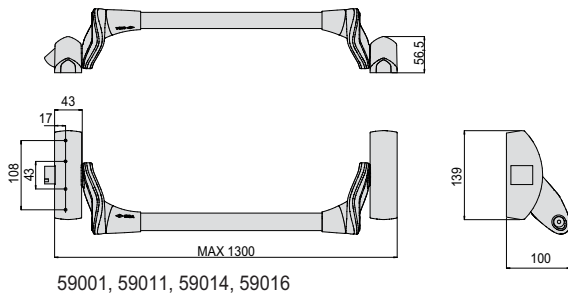

59001, 59011, 59014, 59016

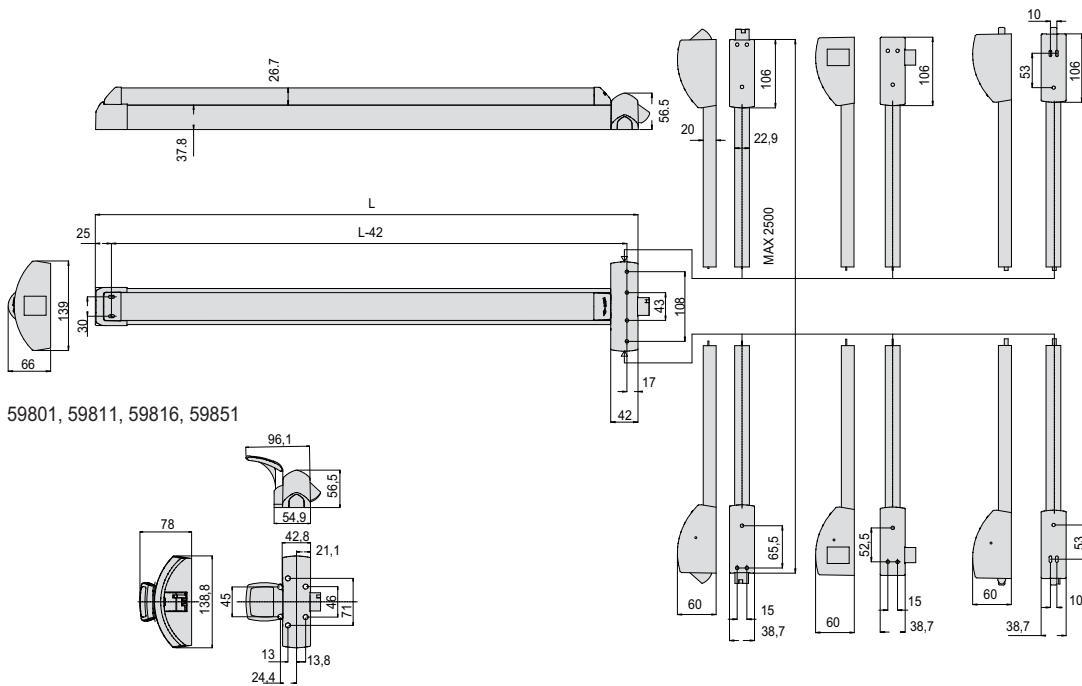

59801, 59811, 59816, 59851

59051, 59091, 59066

07063.51/61/71.0

59014

10

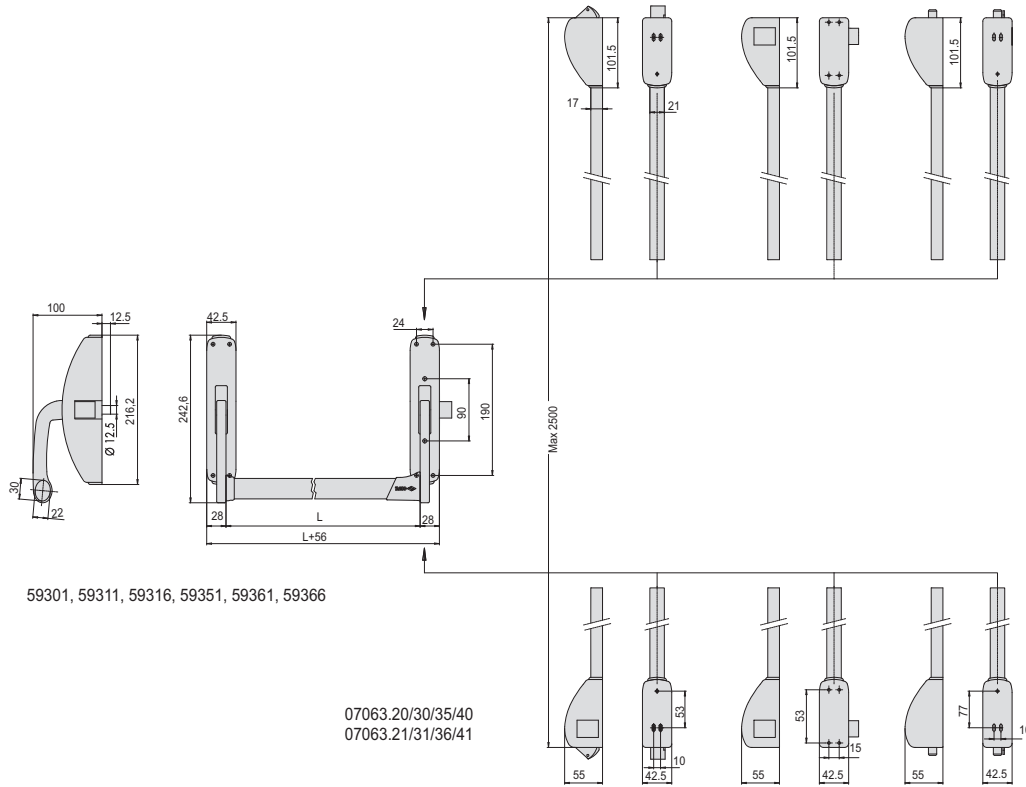

11

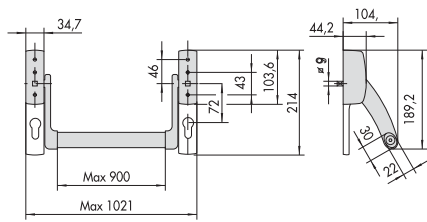

59616

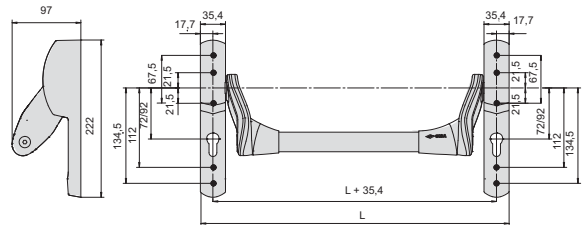
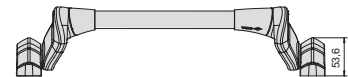

59607 - 59617

12

13

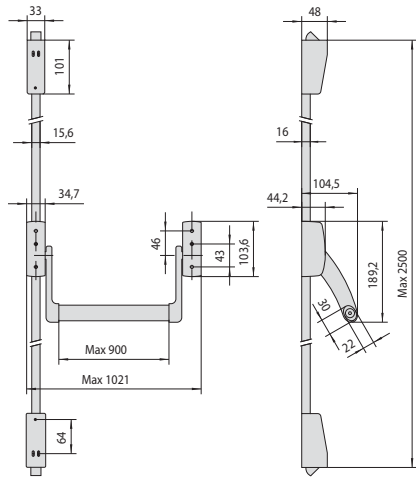

59647

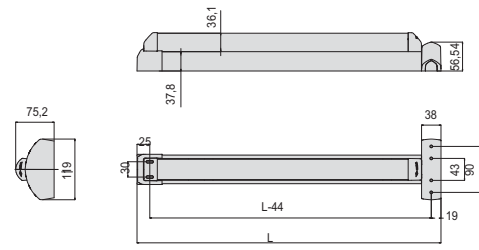

59711, 59751

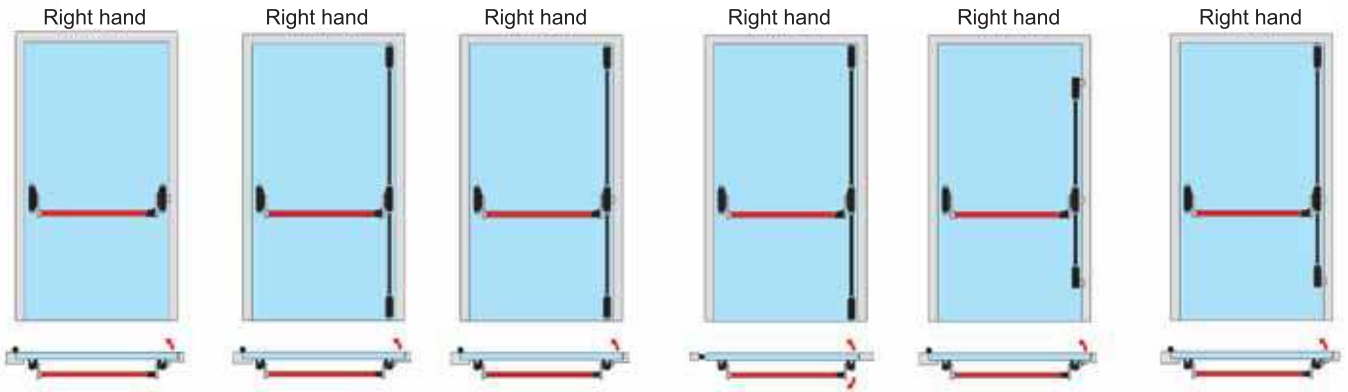

Series CISA PRESTIGE

59301
59351

Series FAST PUSH

59001
59011

Series FAST TOUCH

59801

Serie eFAST

59851

Series CISA PRESTIGE

59311+1-07063-30-0
59316+1-07063-30-0
59351+1-07063-31-0
59366+1-07063-31-0

Series FAST PUSH

59016+1-07063-61-0
59011+1-07063-61-0

Series FAST TOUCH

59816+1-07063-61-0
59811+1-07063-61-0

Series FAST FLOW

59014

Series CISA PRESTIGE

59311+1-07063-30-0
59351+1-07063-31-0

Series FAST PUSH

59011+1-07063-61-0

Series FAST TOUCH

59816+1-07063-61-0

Serie eFAST

59851+1-07063-61-0

Series FAST FLOW

59014

Series CISA PRESTIGE

59316+1-07063-40-0
59366+1-07063-41-0

Series FAST PUSH

59016+1-07063-71-0

Series FAST TOUCH

59816+1-07063-71-0

Series CISA PRESTIGE

59311+1-07063-20-0
59316+1-07063-20-0
59351+1-07063-21-0
59366+1-07063-21-0

Series FAST PUSH

59011+1-07063-51-0
59016+1-07063-51-0

Series FAST TOUCH

59811+1-07063-51-0
59816+1-07063-51-0

Serie eFAST

59851+1-07063-51-0

Series CISA PRESTIGE

59311+1-07063-35-1
59316+1-07063-35-1
59351+1-07063-36-1
59366+1-07063-36-1

Series FAST PUSH

59011+1-07063-66-1
59016+1-07063-66-1

Series FAST TOUCH

59811+1-07063-66-1
59816+1-07063-66-1

Series FAST FLOW

59014

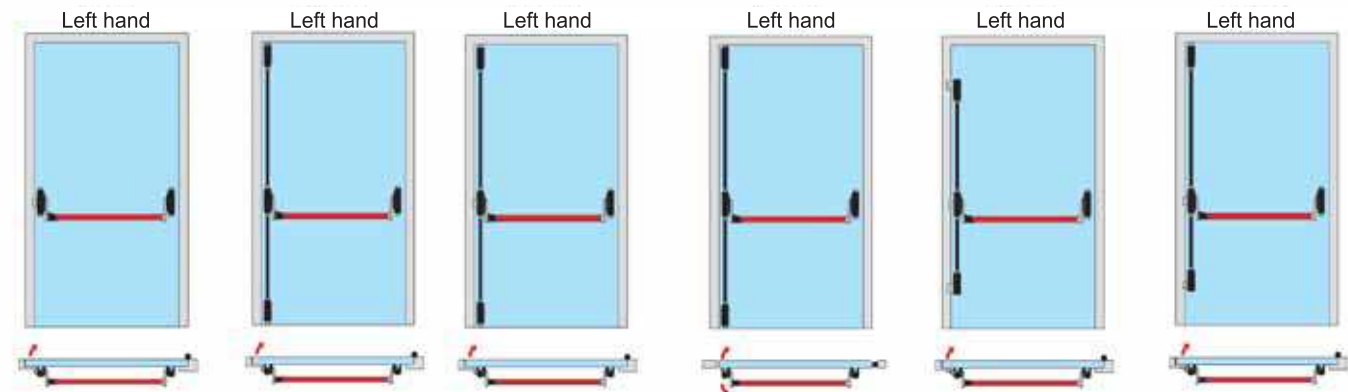

Series CISA PRESTIGE

59301
59351

Series FAST PUSH

59001
59011

Series FAST TOUCH

59801
59811

Serie eFAST

59851

Series CISA PRESTIGE

59311+1-07063-30-0
59316+1-07063-30-0
59351+1-07063-31-0
59366+1-07063-31-0

Series FAST PUSH

59016+1-07063-61-0

59011+1-07063-61-0

Series FAST TOUCH

59816+1-07063-61-0

59811+1-07063-61-0

Series FAST FLOW

59014

Series CISA PRESTIGE

59311+1-07063-30-0
59351+1-07063-31-0

Series FAST PUSH

59011+1-07063-61-0

Series FAST TOUCH

59816+1-07063-61-0

Serie eFAST

59851+1-07063-61-0

Series FAST FLOW

59014

Series CISA PRESTIGE

59316+1-07063-40-0
59366+1-07063-41-0

Series FAST PUSH

59016+1-07063-71-0

Series FAST TOUCH

59816+1-07063-71-0

Series CISA PRESTIGE

59311+1-07063-20-0
59316+1-07063-20-0
59351+1-07063-21-0
59366+1-07063-21-0

Series FAST PUSH

59011+1-07063-51-0

59016+1-07063-51-0

Series FAST TOUCH

59811+1-07063-51-0

59816+1-07063-51-0

Serie eFAST

59851+1-07063-51-0

Series CISA PRESTIGE

59311+1-07063-35-2
59316+1-07063-35-2
59351+1-07063-36-2
59366+1-07063-36-2

Series FAST PUSH

59011+1-07063-66-2

59016+1-07063-66-2

Series FAST TOUCH

59811+1-07063-66-2

59816+1-07063-66-2

Series FAST FLOW

59014

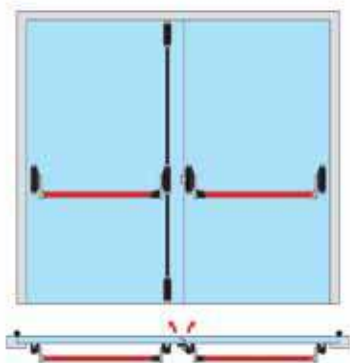

Series CISA PRESTIGE

59301 + 1-07063-30-0 + 59316
 59311 + 1-07063-30-0 + 59311
 59351 + 1-07063-31-0 + 59366
 59361 + 1-07063-31-0 + 59361

Series FAST PUSH

59016 + 1-07063-61-0 + 59001
 59011 + 1-07063-61-0 + 59011

Series FAST TOUCH

59816 + 1-07063-61-0 + 59801
 59811 + 1-07063-61-0 + 59816

Series FAST FLOW

59014 + 59001

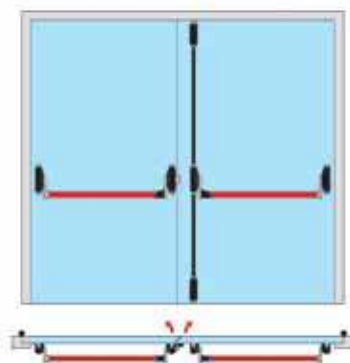

Series CISA PRESTIGE

59301 + 1-07063-30-0 + 59316
 59311 + 1-07063-30-0 + 59311
 59351 + 1-07063-31-0 + 59366
 59361 + 1-07063-31-0 + 59361

Series FAST PUSH

59001 + 1-07063-61-0 + 59016
 59011 + 1-07063-61-0 + 59011

Series FAST TOUCH

59801 + 1-07063-61-0 + 59816
 59811 + 1-07063-61-0 + 59816

Series FAST FLOW

59014 + 59001

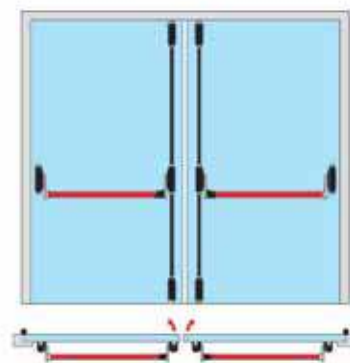

Series CISA PRESTIGE

59311+1-07063-30-0+59301+1-07063-30-0
 59316+1-07063-30-0+59316+1-07063-30-0
 59351+1-07063-31-0+59351+1-07063-31-0
 59366+1-07063-31-0+59366+1-07063-31-0

Series FAST PUSH

59011+1-07063-61-0+59001+1-07063-61-0
 59016+1-07063-61-0+59016+1-07063-61-0

Series FAST TOUCH

59811+1-07063-61-0+59811+1-07063-61-0
 59816+1-07063-61-0+59816+1-07063-61-0

Series FAST FLOW

59014 + 59014

Right hand Left hand

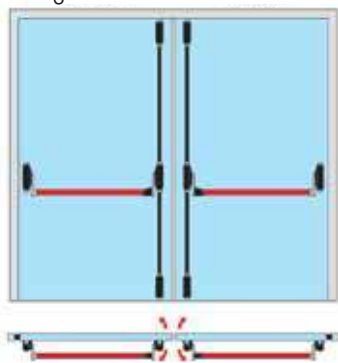

Series CISA PRESTIGE

59311+1-07063-40-0+59301+1-07063-40-0
 59361+1-07063-41-0+59366+1-07063-41-0

Series FAST PUSH

59011+1-07063-71-0+59001+1-07063-71-0
 59016+1-07063-71-0+59016+1-07063-71-0

Series FAST TOUCH

59811+1-07063-61-0+59811+1-07063-61-0
 59816+1-07063-61-0+59816+1-07063-61-0

Right hand Left hand

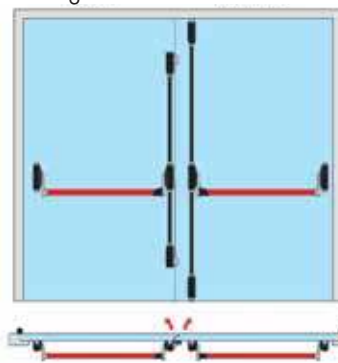

Series CISA PRESTIGE

59311+1-07063-30-0+59316+1-07063-20-0
 59351+1-07063-31-0+59366+1-07063-21-0

Series FAST PUSH

59011+1-07063-51-0+59016+1-07063-61-0

Series FAST TOUCH

59811+1-07063-51-0+59816+1-07063-61-0

Series FAST FLOW

59011 + 107063.51.0+59014

Right hand Left hand

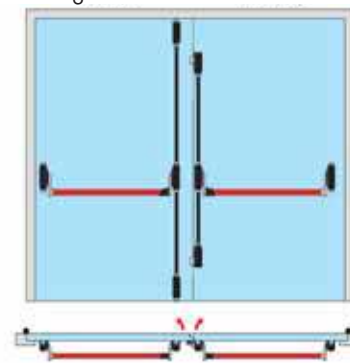

Series CISA PRESTIGE

59316+1-07063-30-0+59311+1-07063-20-0
 59366+1-07063-31-0+59361+1-07063-21-0

Series FAST PUSH

59016+1-07063-61-0+59011+1-07063-51-0

Series FAST TOUCH

59816+1-07063-51-0+59811+1-07063-61-0

Series FAST FLOW

59014 + 59011 + 107063.51.0

NOTE:

Standard version CISA Panic exit devices can be installed on doors 70 mm max thickness, 2500 mm max height, 1300 mm max width. On request they are also available for larger size doors.



Door closers



Door closers D5200 series	553	Accessories for door closers Smart Plus and Professional Plus series	561
Coordinator for Cisa D5200 door closers	554	Door closers 601/T series	564
Cam action door closers D6200 series	555	Accessories for door closers 601 series.....	565
Door closers D7200 series	556	Gate closer	566
Cam action door closers D8200 series	557	Dimensional drawings	567
Door closer PROFESSIONAL PLUS 2 series	558		
Door closers SMART PLUS 2 series	560		





Door closer D5200 series

**Ease of opening, maximum
security in closing**



CISA D5200 series asymmetric rack and pinion door closers

The CISA D5200 series guarantees exceptional ease of use by reducing the resistance encountered when opening the door.

In contrast to conventional door closers, asymmetric rack and pinion technology ensures maximum opening efficiency. The initial opening power decreases rapidly, allowing even children and the elderly to open the door easily.

The CISA D5200 series is CE marked to EN1154 and fire tested to EN1634 – 1 with a 2-hour fire rating on wooden doors.

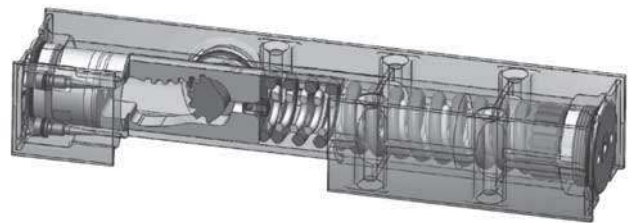

cisa.com
allegion.com



ALLEGION™



Technical features:

- Steel sliding arm with or without hold open device
- Adjustment valve with thermostatic device.

Operation:

- Adjustable closing speed and end stroke
- Adjustable strength
- Backcheck (opening brake)

Supplied as standard:

- Screws
- Adhesive templates

On request:

- Mounting plates
- Replacement arm with or without hold open







Finishes:

- SUPPLIED AS STANDARD:
 - Aluminum (fin. 97)
- FINISH OPTIONS:
 - Black (fin. 44)
 - White (fin. 45)
 - Brown (fin. 88)

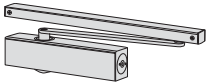
Standards:

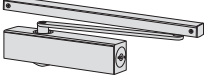
- CE marking in compliance with the Construction Products Regulation 305/2011

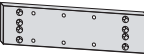
D5200

Type	Description	Closing strength	Max. door width	Max. door weight	Unit weight	Pieces	ITEM					
							Type	Dim.	Hand	Fin.	Pers. Spec.	
 	<ul style="list-style-type: none"> • For inward/outward opening doors • Without hold open 	1÷4	1100	80	2,200	1	1	D5200	03	0	97	
	<ul style="list-style-type: none"> • For inward/outward opening doors • With hold open 	1÷4	1100	80	2,304	1	1	D5210	03	0	97	
	<ul style="list-style-type: none"> • Slide track without hold open item D5200 				0,600	1	1	07157	10	0	97	
	<ul style="list-style-type: none"> • Slide track with hold open item D5210 				0,700	1	1	07157	11	0	97	
	<ul style="list-style-type: none"> • Mounting plate item D5200 for installation on fire doors 				0,300	1	1	07153	15	0	97	
	<ul style="list-style-type: none"> • Hold open device for door closers D5210 series 				0,300	1	1	07209	03	0		



Technical features:

- Ensures double doors always shut in the right sequence
- Can be installed with CISA D5200 door closers, **to be ordered separately**

Supplied as standard:

- Assembly kit
- Installation instructions
- Carry bar to be installed on emergency doors with panic bar

Finishes:

Standard:

- Silver Fin 97

On request:

- Black Fin 44
- White Fin 45
- Dark brown Fin 88

Standards:

- CE marking in compliance with the Construction Products Regulation 89/106/CEE issued by ICIM
- CE marking in compliance with the Construction Products Regulation 305/2011

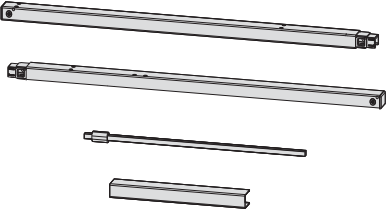
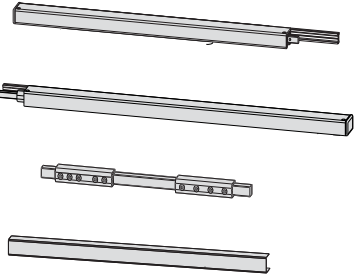
Type	Description	Kg	Pieces	ITEM				
				Type	Dim.	Hand	Fin.	Pers. Spec.
	<p>Version for right and left hand pull doors</p> <ul style="list-style-type: none"> • Side of active leaf (right /left) can be chosen at installation • Maximum opening angle 175° (depending on the door profile and frame used) • Minimum width of inactive leaf 360 mm • Distance between the hinges 1495 mm - 2640 mm. • For smaller distances (1370 mm - 1490 mm), the profile of the active leaf can be reduced to 130 mm. • The device can be installed directly onto the door or using the plates supplied. 	2,000	1	1	07158	00	0	97
	<p>Version for right and left hand push doors</p> <ul style="list-style-type: none"> • Maximum opening angle 110° (depending on the door profile and frame used) • Minimum width of inactive leaf 600 mm • Distance between the hinges 1440 mm – 2500 mm. 	2,000	1	1	07159	00	0	97



Technical features:

- Steel sliding arm with or without hold open device
- Cam operated.
- Adjustment valve with thermostatic device.

Operation:

- Adjustable closing speed and end stroke
- Adjustable strength
- Backcheck (opening brake)

Supplied as standard:

- Screws
- Adhesive templates

Finishes:

- **SUPPLIED AS STANDARD:**
 - Aluminum (fin. 97)
- **FINISH OPTIONS:**
 - Black (fin. 44)
 - White (fin. 45)
 - Champagne (fin. 87)
 - Brown (fin. 88)
 - Matt black (fin. 90)

Standards:

- CE marking in compliance with the Construction Products Regulation 305/2011

D6200

Type	Description	Closing strength	Max. door width	Max. door weight	Unit weight 	Pieces 	ITEM			
							Type	Dim. Hand	Fin.	Pers. Spec.

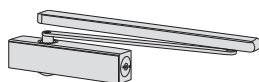

- For inward opening doors (door closer body installed on the door leaf and arm on the door frame)
- Standard track arm

2÷4 1100 80 2,300 1 1 **D6200 03 0 97**

- For outward opening doors (door closer body installed on the door leaf and arm installed on the frame)
- Standard track arm

2÷4 1100 80 2,300 1 1 **D6210 03 0 97**

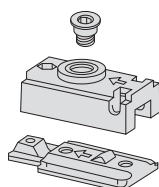

- Hold open unit for D6200 series

- - - - 1 1 **07209 02 0**



Technical features:

- Cast iron pressed body
- Steel slider arm with or without stop
- Cam-controlled operation
- Adjustment valves with thermostatic device.

Operation:

- Closing rate
- End stroke
- Closure delay
- Opening brake
- Actuating force
- Stop position

Supplied as standard:

- Pre-assembly plate
- Screws
- Adhesive templates



Finishes:

- **STANDARD:**
 - Aluminum (fin. 97)
- **FINISHING OPTIONS:**
 - Black (fin. 44)
 - White (fin. 45)
 - Champagne (fin. 87)
 - Dark brown (fin. 88)
 - Dark bronze (fin. 99)
 - Satin-finished stainless steel (fin. C2)

Standards:

- CE marking in compliance with the Construction Products Regulation 305/2011

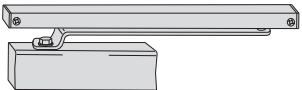
D7200

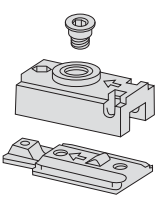
Type	Description	Closing strength	Max. door width	Max. door weight	Unit weight	Pieces	ITEM				
							Type	Dim.	Hand	Pers. Spec.	
 	<ul style="list-style-type: none"> • For inward opening doors (door closer body installed on the door leaf and arm on the door frame) • Standard track arm 	2÷5	1250	100	6,000	1	1	D7200	04	0	97
	<ul style="list-style-type: none"> • For outward opening doors (door closer body installed on the door arm installed on the frame) • Standard track arm 	2÷5	1250	100	6,000	1	1	D7210	04	0	97
	<ul style="list-style-type: none"> • Hold open unit for D7200 series door closers 	5	1250	100	6,000	1	1	07210	00	0	



Technical features:

- Cast iron pressed body
- Steel slider arm with or without stop
- Cam-controlled operation
- Adjustment valves with thermostatic device.

Operation:

- Adjustable closing speed and end stroke
- Adjustable strength

Supplied as standard:

- Screws
- Adhesive templates





Finishes:

- STANDARD:
 - Aluminum (fin. 97)

Standards:

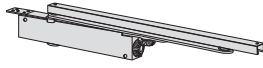
- CE marking in compliance with the Construction Products Regulation 305/2011

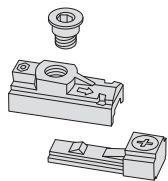
D8200

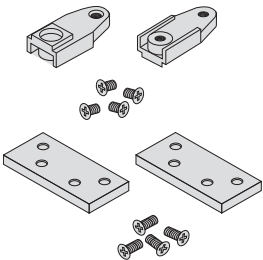
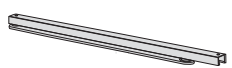
Type	Description	Closing strength	Max. door width	Max. door weight	Unit weight	Pieces	ITEM					
							Type	Dim.	Hand	Fin.	Pers. Spec.	
 	<ul style="list-style-type: none"> • For inward opening doors (door closer body mounted on the door leaf; slide track mounted on the door frame) • Without hold open device 	2÷4	1100	80	1,900	1	1	D8200	03	0	97	
	<ul style="list-style-type: none"> • Hold open device for D8200 series 	-	-	-	-	1	1	07209	00	0		
	<ul style="list-style-type: none"> • Hold-open device 	-	-	-	-	1	1	07209	01	0		
	<ul style="list-style-type: none"> • Protection kit for installation on fire doors 	-	-	-	-	1	1	07209	21	0		
	<ul style="list-style-type: none"> • Mounting kit for aluminium door frames 	-	-	-	-	1	1	07209	25	0		
	<ul style="list-style-type: none"> • Replacement arm for item D8200 	-	-	-	-	1	1	07209	20	0	97	



Technical features:

- Adjustable steel arm with hold open device
- Solid aluminium body with slide-on cover

Operation:

- Closing strength: multiple strength version with adjustable position of body and arm hinge mechanism (C15 model)
Adjustable strength version: adjusted via the screw on the body side (C16 and C21 models)
- Closing strength and end stroke adjustment valves for easier access. Valves protection cover to avoid any unauthorised adjustment
- Adjustable closing strength from 180° to 15° via the valve (closing)
- Adjustment of the end stroke from 15° to

0° via the valve (latch)

- Adjustable backcheck (opening brake) to reduce the risk of damaging the door and the adjacent walls
- Adjustment of stop position up to 130° (function not suitable for fire doors)

Supplied as standard:

- Fixing screws
- Template and installation instructions

Finishes:







- SUPPLIED AS STANDARD:
 - Grey (fin. 97)
- FINISH OPTIONS:
 - Black (fin. 44)
 - White (fin. 45)
 - Champagne (fin. 87)
 - Brown (fin. 88)
 - Matt black (fin. 90)

Standards:

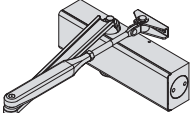
- CE marking in accordance with the regulation 305/2011

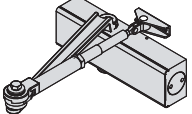
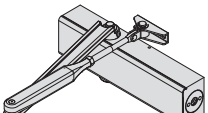

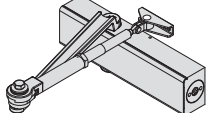
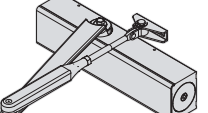
Professional Plus 2

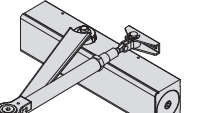
Type	Description	Closing strength	Max. door width	Max. door weight	Unit weight	Pieces	ITEM				
							Type	Dim.	Hand	Fin.	Pers.
  	<ul style="list-style-type: none"> • MULTISTRENGTH • Arm without hold open device 	2-4	850÷1100	40÷80	2,300	1	1	C1510	03	0	97
	<ul style="list-style-type: none"> • MULTISTRENGTH • With hold open device on arm 	2-4	850÷1100	40÷80	2,300	1	1	C1511	03	0	97
  	<ul style="list-style-type: none"> • ADJUSTABLE STRENGTH • Without hold-open • Backcheck (opening brake) 	2-4	850÷1100	40÷80	3,100	1	1	C1610	03	0	97
	<ul style="list-style-type: none"> • ADJUSTABLE STRENGTH • Arm with hold-open • Backcheck (opening brake) 	2-4	850÷1100	40÷80	3,100	1	1	C1611	03	0	97
  	<ul style="list-style-type: none"> • ADJUSTABLE STRENGTH • Without hold-open • Backcheck (opening brake) 	2-6	850÷1400	40÷120	3,500	1	1	C1610	05	0	97
	<ul style="list-style-type: none"> • ADJUSTABLE STRENGTH • Arm with hold-open • Backcheck (opening brake) 	2-6	850÷1400	40÷120	3,500	1	1	C1611	05	0	97

Type	Description	Closing strength	Max. door width	Max. door weight	Unit weight 	Pieces 	ITEM			
							Type	Dim.	Hand	Fin.

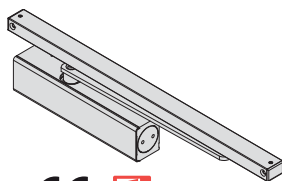

- Slide track
- Arm with hold-open

3 950 60 2,600 1 1 C2010 03 0 97

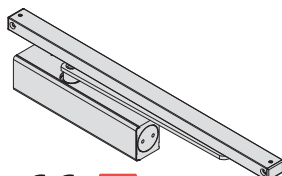

- ADJUSTABLE STRENGTH VERSION
- Slide track
- Without hold-open
- Backcheck (opening brake)

2÷4 850÷1100 40÷80 3,700 1 1 C2110 03 0 97





Technical features:

- Steel arm with hold-open device.
- Solid body in die-cast aluminium alloy
- Rack-and-pinion mechanism in hardened steel for smooth, efficient operation
- Removable ABS cover

Operation:

- Multi-strength version with adjustable position of body and arm hinge mechanism, strength 2 and 3 (ENn54), strength 3 (CE)
- Independent closing speed and end stroke adjustment valves.
- Closing strength adjustable from 180° to 15° via the valve (1).
- End stroke adjustable from 15° to 0° via the valve (2).
- Adjustment of stop position up to 130° (function not suitable for fire doors)

Supplied as standard:

- Fixing screws
- Template and installation instructions

Finishes:

- Standard
 - Aluminium (fin. 97)
- Finish options
 - Champagne (fin. 87)
 - Brown (fin. 88)
 - Black (fin. 44)
 - Matt black (fin. 90)
 - White (fin. 45)

Standards:

- CE marking in accordance with the regulation 305/2011

Smart Plus 2

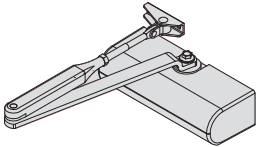
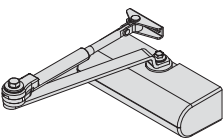

Type	Description	Closing strength	Max. door width	Max. door weight	Unit weight	Pieces	ITEM				
							Type	Dim.	Hand	Pers. Spec.	
	<ul style="list-style-type: none"> • MULTISTRENGTH • Arm without hold open device • CE mark according to Directive 89/106/CEE 	3	950	60	1,800	1	1	C1415	03	0	97
	<ul style="list-style-type: none"> • MULTISTRENGTH • With hold open device on arm 	2-4	850-1100	40-80	1,800	6	1	C1416	03	0	97

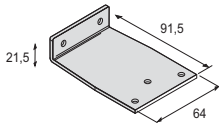
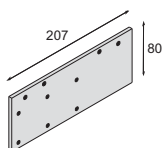
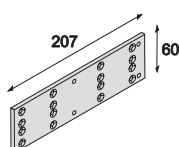
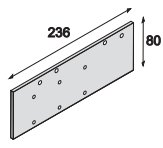
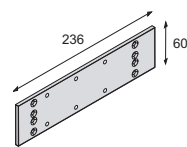
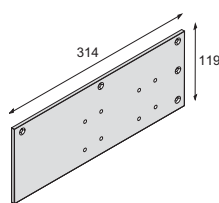
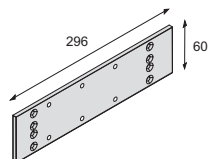

Type	Description	Unit weight Kg	Pieces	ITEM					
				Type	Dim.	Hand	Fin.	Pers. Spec.	
	<p>The required finish must always be specified in the order (where necessary)</p> <ul style="list-style-type: none"> • Finishes available: <ul style="list-style-type: none"> - Champagne colour (fin. 87) - Dark brown colour (fin. 88) - Aluminium colour (fin. 97) - Black colour (fin. 44) - Matt black colour (fin. 90) - Dark bronze colour (fin. 99) - White colour (fin. 45) 								
	• Steel angle backplate parallel arm steel angle backplate for C1415 and C1416, C1500, C1600 series	0,230	1	1	07141	01	0	97	
	• Steel backplate door closers steel plate for C1510 03 and C1511 03 series			1	1	07142	01	0	97
	• Steel backplate door closers steel plate for C1510 03 and C1511 03 series			1	1	07153	02	0	97
	• Steel backplate door closers steel plate for C1610 03 and C1611 03 series			1	1	07153	03	0	97
	• Steel backplate door closers steel plate for C1610 03, C1611 03 and C2010 03 series			1	1	07153	04	0	97
	• Steel backplate door closers steel plate for C1610 05, C1611 05 and C2110 03 series			1	1	07153	05	0	97
	• Steel backplate door closers steel plate for C1610 05 and C1611 05 series			1	1	07153	06	0	97

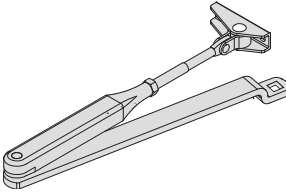
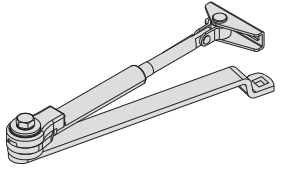
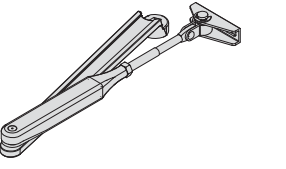
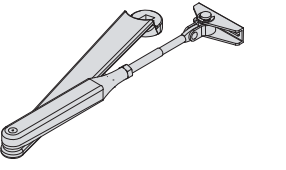
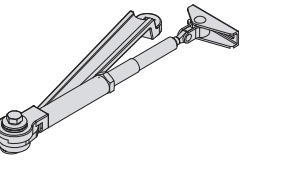
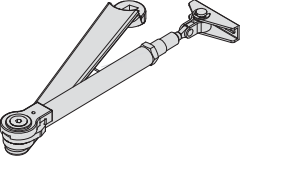
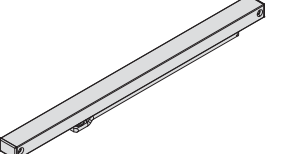
Type	Description	Unit weight Kg	Pieces	ITEM			
				Type	Dim.	Hand	Fin. Pers. Spec.
	<ul style="list-style-type: none"> • Steel sliding arm without hold-open device • For Smart Plus 2 door closers 	0,460	1	1	07155	10	0 97
	<ul style="list-style-type: none"> • Steel sliding arm with hold-open device • For Smart Plus 2 door closers 	0,460	1	1	07155	11	0 97
	<ul style="list-style-type: none"> • Steel sliding arm without hold-open device • For Smart Plus 2 Closing Force 3 door closers 	0,460	1	1	07155	12	0 97
	<ul style="list-style-type: none"> • Steel sliding arm without hold-open device • For Smart Plus 2 Closing Force 5 door closers 	0,460	1	1	07155	14	0 97
	<ul style="list-style-type: none"> • Steel sliding arm with hold-open device • For Smart Plus 2 Closing Force 3 door closers 	0,900	1	1	07155	13	0 97
	<ul style="list-style-type: none"> • Steel sliding arm with hold-open device • For Smart Plus 2 Closing Force 5 door closers 	0,900	1	1	07155	15	0 97
	<ul style="list-style-type: none"> • Steel sliding arm with aluminium slide track • For Professional Plus 2 door closers, C2010 series 	0,700	1	1	07155	20	0 97

Type	Description	 Unit weight  Pieces	ITEM			
			Type	Dim.	Hand	Fin.

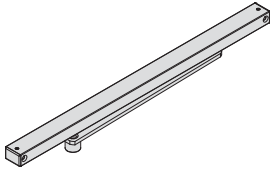

- Steel sliding arm with aluminium slide track
- For Professional Plus 2 door closers, C2110 series

0,800 1 1 07155 21 0 97

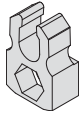

- Closer hold-open device with sliding arm for C2010 03 and C2110 03 series

1 1 07210 01 0



Technical features:

- Solid cast iron body
- Steel arm, with or without hold open device
- ADJUSTMENTS:
Closing speed adjusting valve

On request:

- Kit of spare springs art. 1.07103.03.0

Supplied as standard:

- Fixing screws
- Installation template

Finishes:

- The required finish must always be specified in the order
- Finishes available:
aluminium colour (fin. 97)
gold colour (fin. 98)

Type	Description	Closing strength	Max. door width	Max. door weight	Unit weight	Pieces	ITEM			
							Type	Dim.	Hand	Pers. Spec.

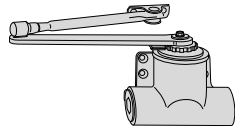

- Arm without hold-open device

1	750	30	2,392	2	1 60130 01 0 98
2	830	45	3,167	2	1 60140 02 0 98
3	930	60	3,717	2	1 60150 03 0 98
4	1030	80	4,900	2	1 60160 04 0 98

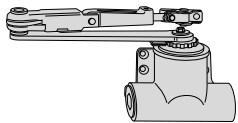

- Arm with hold-open device

1	750	30	2,480	2	1 60131 01 0 98
2	830	45	3,205	2	1 60141 02 0 98
3	930	60	3,705	2	1 60151 03 0 98
4	1030	80	5,025	2	1 60161 04 0 98

Type	Description	For series/item	L	Unit weight 	Pieces 	ITEM			
						Type	Dim.	Hand	Fin.

The required finish must always be specified in the order (where necessary)

- Finishes available
 - aluminium colour (fin. 97)
 - gold colour (fin. 98)
 - dark bronze colour (fin. 99)

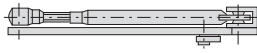

- Steel arm without hold-open device

60130, 60170 200,0 0,420 1 1 07132 00 0 97

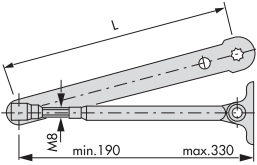

60140, 60150, 240,0 0,475 1 1 07134 00 0 97
60160, 60180,
60190

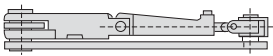

- Steel arm with hold-open device

60131, 60171 200,0 0,515 1 1 07133 00 0 97

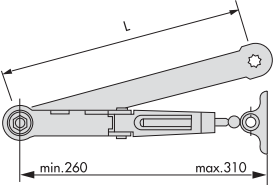

60141, 60151, 240,0 0,595 1 1 07135 00 0 97
60161, 60181,
60191



Technical features:

- Pressure die-cast aluminium case and cover, painted and anti-corrosion treatment (resists more than 500 hours in salt spray)
- Stainless steel sliding arm
- Stainless steel adjusters
- Zinc-plated fixing screws
- Zinc-plated steel springs
- Tested for 200,000 opening and closing cycles

Operation:

- For use on gates up to 1200 mm and weighing a maximum of 55 kg
- Completely mechanical operation with no fluids (operates irrespective of outdoor

temperature).

- Adjustable opening / closing force
- Adjustable closing speed
- Possibility of hold open between 90° and 100°
- Maximum opening of gate 100°
- Courtesy opening function
- Possibility of inverting operation from "gate closer" to "gate opener"

Supplied as standard:

- Zinc-plated adjustable corner mounting plate item 1.07155.01.0.
- Sliding arm
- Kit of spare springs
- Fixing screws
- Instruction sheet

On request:

- Kit of spare springs 07156.03.0

Finishes:

- Black
- Silver grey

Standards:

- Patented system A000790 of 2013

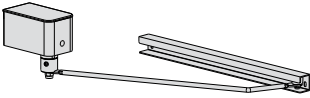
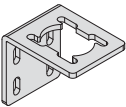
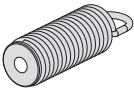
Type	Description	Closing strength	Max. door width	Max. door weight	Unit weight	Pieces	ITEM							
							Type	Dim.	Hand	Fin.	Pers.	Spec.		
 <ul style="list-style-type: none"> • BLACK gate closer with sliding arm 		2,500	1	1	2,500	1	1	C1310	11	1				
		2,500	1	1	2,500	1	1	C1310	11	2				
	<ul style="list-style-type: none"> • GREY gate closer with sliding arm 		2,500	1	1	2,500	1	1	C1310	11	1	97		
			2,500	1	1	2,500	1	1	C1310	11	2	97		
 <ul style="list-style-type: none"> • Corner plate (supplied as standard) 		0,450	1	1	0,450	1	1	07155	01	0				
 <ul style="list-style-type: none"> • Kit of spare springs 					0,500	1	1	07156	03	0				

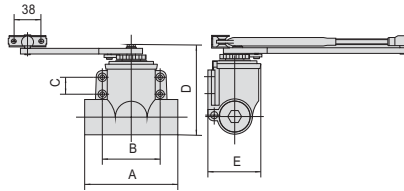

	A	B	C	D	E
1.60130.01	132	75,5	19	144	68
1.60131.01	132	75,5	19	144	68
1.60140.02	137	82	24	124	73
1.60141.02	137	82	24	124	73
1.60150.03	147	92	29	140	81
1.60151.03	147	92	29	140	81
1.60160.04	150	105	31	156	96
1.60161.04	150	105	31	156	96

1

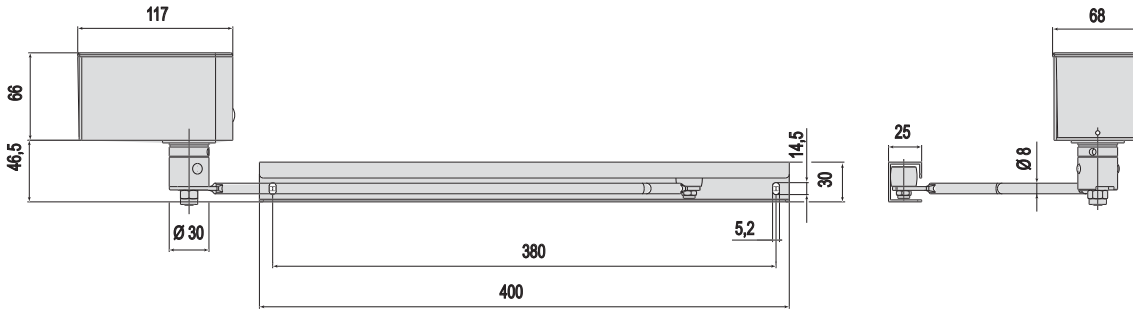

2

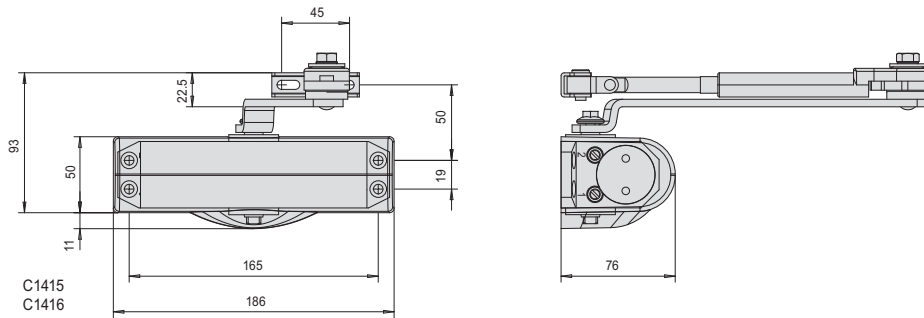

3

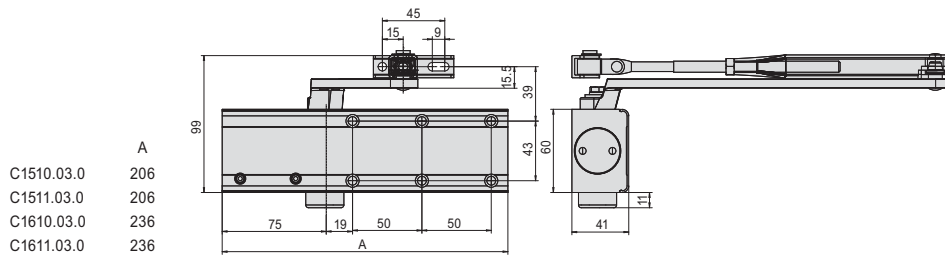

4

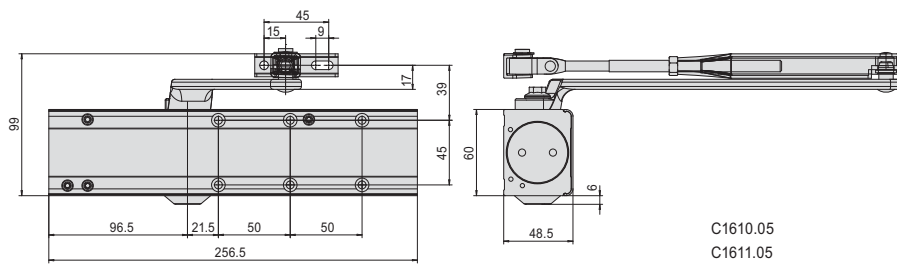

5

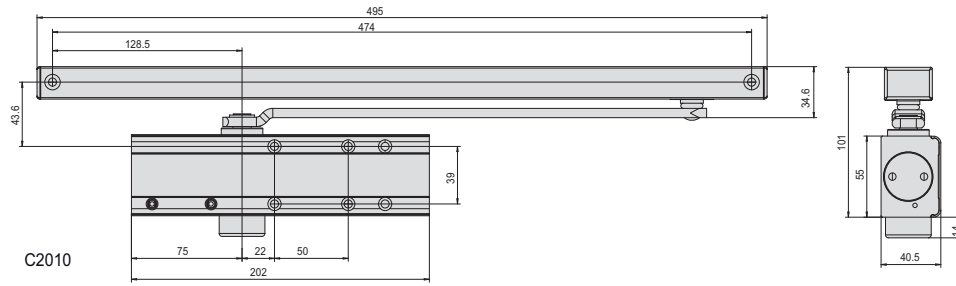

6

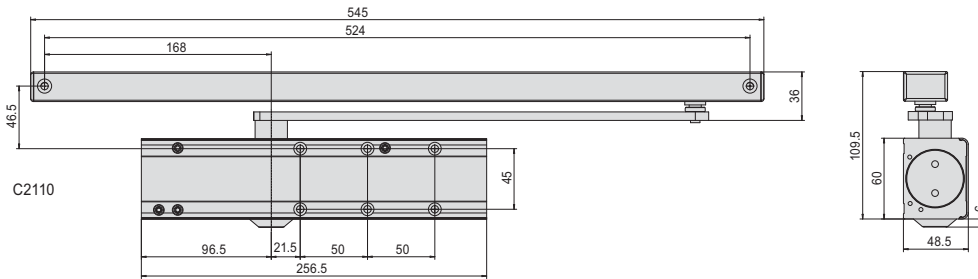

7

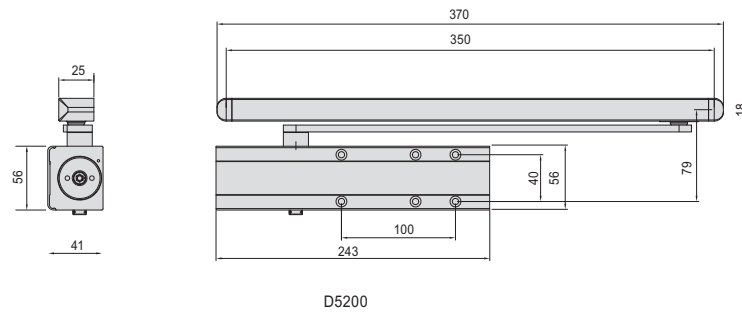

8

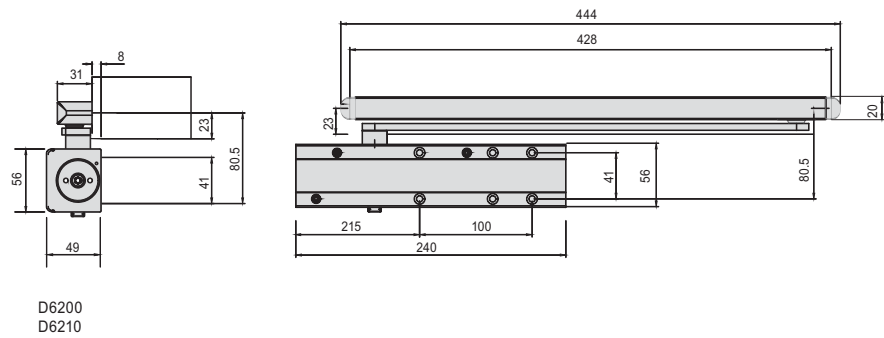

9

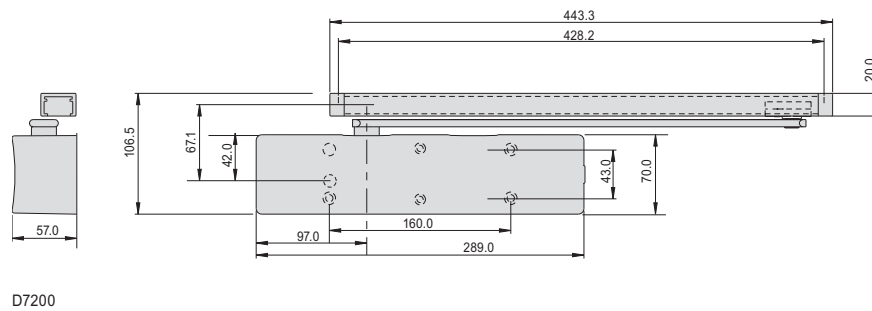

10

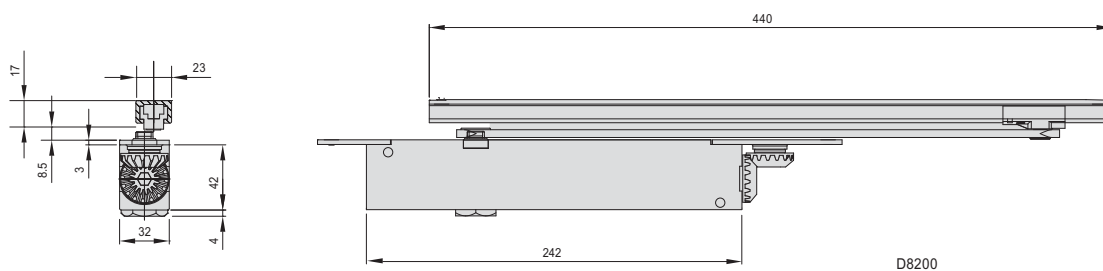

11



CISA®

Safes



Wall safes with electronic combinator - Digit vision.....	571	Standing safes with key	578
Wall safes with key	572	Standing safes with mechanical combinator.....	579
Wall safes, with mechanical combinator.....	573	Standing safes, 1 star key	580
Darwin series modular wall safes.....	574	Hotel safes - Digit Plus	581
Wall safes, 1 star key	575	Spare parts and accessories for safes	582
Standing safes with electronic combinator -		Safe display stands.....	588
Digit vision	576	Dimensional drawing.....	589
CASH Standing safes with electronic combinator	577		





Technical features:

- Lit keypad.
- 10 mm thick steel front (12 mm. for the 420x550 and 490x620 versions)
- Seals are assembled using tough welds
- Nickel-plated rolling steel deadbolts (diameter 22 mm)
- Special high-resistance anti-corrosion kiln painting
- Carbonitrided steel lock protection plate
- Lock and mechanisms are fixed directly onto the door of the safe
- Opening commands do not protrude when in the rest position

Supplied as standard:

- Power cable
- Shelves (where these are provided for)
- Use and maintenance instructions
- Installation instructions.

Certifications:

- Complies with the electromagnetic compatibility standard EN 55014-1 / 2: 2021

DGT Vision

Type	Description	Prompt delivery	Outside dim.			Door thickness	Vertical bolts	Horizontal bolts	No. of shelves	Unit weight	Pieces	ITEM			
			L	H	P							Type	Dim.	Hand Fin.	Pers. Spec.

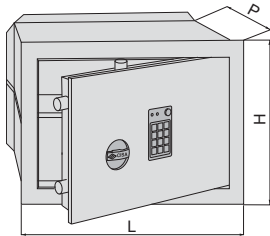

- Back-lit alphanumeric keypad
- Electronic combinator
- Internal light
- 1.5 V alkaline thin battery operation
- Removable door
- Laser welded sealing parts assembly
- Sound and visual indications
- Tamper-proof lock

*	360	240	150	10	2	1	14,400	1	1 82710 30 0				
*	360	240	200	10	2	1	15,400	1	1 82710 31 0				
*	360	240	250	10	2	1	16,700	1	1 82710 32 0				
*	420	300	200	10	2	2	21,600	1	1 82710 40 0				
*	420	300	250	10	2	2	23,100	1	1 82710 41 0				
*	420	300	300	10	2	2	24,900	1	1 82710 42 0				
*	490	360	200	10	2	2	28,950	1	1 82710 50 0				
*	490	360	250	10	2	2	30,000	1	1 82710 51 0				
	490	360	300	10	2	2	31,750	1	1 82710 52 0				
	360	490	200	10	2	4	29,350	1	1 82710 70 0				
	360	490	250	10	2	4	31,000	1	1 82710 71 0				
	360	490	300	10	2	4	32,700	1	1 82710 72 0				
	420	550	200	12	2	4	39,700	1	1 82710 80 0				
	420	550	250	12	2	4	39,700	1	1 82710 81 0				
	420	550	300	12	2	4	39,700	1	1 82710 82 0				
	490	620	200	12	2	4	51,000	1	1 82710 90 0				
	490	620	250	12	2	4	51,000	1	1 82710 91 0				
	490	620	300	12	2	4	51,000	1	1 82710 92 0				



Technical features:

- 10 mm. thick steel front (12 mm. for the 420x550 and 490x620 versions)
- Seals are assembled through automated welding
- Nickel-plated steel deadbolts (diameter 22 mm.)
- Special, high-resistance anti-corrosion kiln painting
- Carbonitrided steel lock protection plate
- Lock and mechanisms are fixed directly onto the door of the safe
- Opening commands do not protrude when in the rest position

Supplied as standard:

- Shelves (where these are provided for)
- Instruction sheet
- Installation instructions

Type	Description	Prompt delivery	Outside dim.			Door thickness	Vertical bolts	Horizontal bolts	No. of shelves	Kg	Pieces	ITEM			
			L	H	P							Type	Dim.	Hand	Fin.

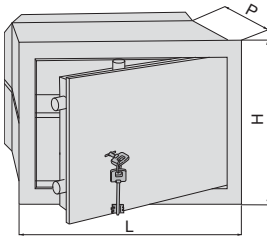

- Key only version
- 2 keys item 1.00101.00.2

	260	170	150	10	2	-	8,300	1	1	82010 10 0				
	260	170	200	10	2	-	9,300	1	1	82010 11 0				
*	310	190	150	10	2	1	10,600	1	1	82010 20 0				
*	310	190	200	10	2	1	11,400	1	1	82010 21 0				
	360	240	150	10	2	1	14,550	1	1	82010 30 0				
*	360	240	200	10	2	1	15,600	1	1	82010 31 0				
	360	240	250	10	2	1	16,900	1	1	82010 32 0				
*	420	300	200	10	2	2	21,600	1	1	82010 40 0				
*	420	300	250	10	2	2	25,000	1	1	82010 41 0				
	420	300	300	10	2	2	24,500	1	1	82010 42 0				
	490	360	200	10	2	2	33,000	1	1	82010 50 0				
*	490	360	250	10	2	2	30,500	1	1	82010 51 0				
	490	360	300	10	2	2	31,700	1	1	82010 52 0				
	360	490	200	10	2	4	32,200	1	1	82010 70 0				
	360	490	250	10	2	4	34,400	1	1	82010 71 0				
	360	490	300	10	2	4	35,700	1	1	82010 72 0				
	420	550	200	12	2	4	39,700	1	1	82010 80 0				
	420	550	250	12	2	4	41,300	1	1	82010 81 0				
	420	550	300	12	2	4	43,500	1	1	82010 82 0				
	490	620	200	12	2	4	51,000	1	1	82010 90 0				
	490	620	250	12	2	4	52,800	1	1	82010 91 0				
	490	620	300	12	2	4	54,800	1	1	82010 92 0				



Technical features:

- 10 mm. thick steel front (12 mm. for the 420x550 and 490x620 versions)
- Seals are assembled using tough welds
- Nickel-plated rolling steel deadbolts (diameter 22 mm.)
- Special, high-resistance anti-corrosion kiln painting
- Carbonitrided steel lock protection plate
- Lock and mechanisms are fixed directly onto the door of the safe.
- Opening commands do not protrude when in the rest position

Supplied as standard:

- Shelves (where these are provided for)
- Instruction sheet
- Installation instructions

Type	Description	Prompt delivery	Outside dim.			Door thickness	Vertical bolts	Horizontal bolts	No. of shelves	Unit weight	Pieces	ITEM			
			L	H	P							Type	Dim.	Hand	Fin.

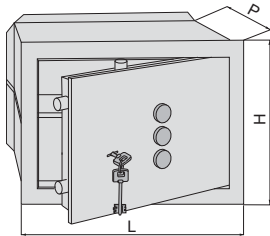

- Key and 3-knob combinator version
- 2 keys item 1.00101.00.2

310	190	150	10	2	1	11,000	1	1	82210 20 0
310	190	200	10	2	1	12,000	1	1	82210 21 0
360	240	150	10	2	1	15,000	1	1	82210 30 0
*	360	240	200	10	2	15,850	1	1	82210 31 0
360	240	250	10	2	1	12,900	1	1	82210 32 0
*	420	300	200	10	2	22,200	1	1	82210 40 0
420	300	250	10	2	2	23,500	1	1	82210 41 0
420	300	300	10	2	2	24,750	1	1	82210 42 0
490	360	200	10	2	2	28,700	1	1	82210 50 0
490	360	250	10	2	2	30,500	1	1	82210 51 0
490	360	300	10	2	2	32,000	1	1	82210 52 0
360	490	200	10	2	4	29,400	1	1	82210 70 0
360	490	250	10	2	4	30,950	1	1	82210 71 0
360	490	300	10	2	4	36,150	1	1	82210 72 0
420	550	200	12	2	4	40,000	1	1	82210 80 0
420	550	250	12	2	4	42,850	1	1	82210 81 0
420	550	300	12	2	4	43,900	1	1	82210 82 0
490	620	200	12	2	4	51,000	1	1	82210 90 0
490	620	250	12	2	4	52,800	1	1	82210 91 0
490	620	300	12	2	4	55,250	1	1	82210 92 0

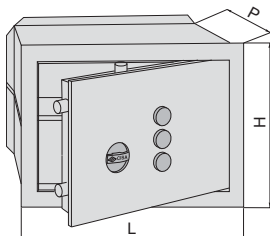

- 3-knob combinator only version

310	190	150	10	2	1	10,800	1	1	82410 20 0
310	190	200	10	2	1	11,700	1	1	82410 21 0
360	240	150	10	2	1	14,700	1	1	82410 30 0
*	360	240	200	10	2	15,800	1	1	82410 31 0
360	240	250	10	2	1	17,300	1	1	82410 32 0
420	300	200	10	2	2	22,000	1	1	82410 40 0
420	300	250	10	2	2	23,150	1	1	82410 41 0
420	300	300	10	2	2	24,500	1	1	82410 42 0
490	360	200	10	2	2	28,950	1	1	82410 50 0
490	360	250	10	2	2	30,700	1	1	82410 51 0
490	360	300	10	2	2	35,000	1	1	82410 52 0
360	490	200	10	2	4	29,500	1	1	82410 70 0
360	490	250	10	2	4	31,000	1	1	82410 71 0
360	490	300	10	2	4	35,700	1	1	82410 72 0
420	550	200	12	2	4	40,700	1	1	82410 80 0
420	550	250	12	2	4	42,000	1	1	82410 81 0
420	550	300	12	2	4	44,000	1	1	82410 82 0
490	620	200	12	2	4	50,700	1	1	82410 90 0
490	620	250	12	2	4	53,000	1	1	82410 91 0
490	620	300	12	2	4	54,500	1	1	82410 92 0



Technical features:

- Modular front and safe compartment
- 10 mm. thick steel front
- Seals are assembled using tough welds
- Nickel-plated rolling steel deadbolts (diameter 22 mm.)
- Special high-resistance anti-corrosion kiln painting
- Carbonitrided steel lock protection plate
- Lock and mechanisms are fixed directly onto the door of the safe.
- Opening commands do not protrude when in the rest position

Supplied as standard:

- Frame edge cover
- Shelf
- Bolts for fixing the compartment
- Instruction sheet
- Installation instructions

Certifications:

- Complies with the electromagnetic compatibility standard EN 55014-1 / 2: 2021

Darwin

Type	Description	Prompt delivery	Outside dim.			Door thickness	Vertical bolts	Horizontal bolts	No. of shelves	Unit weight Kg	Pieces	ITEM				
			L	H	P							Type	Dim.	Hand	Fin.	Pers.

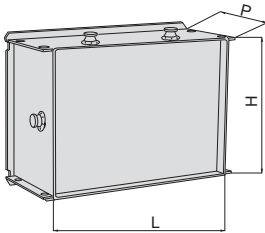

- Safe compartment with temporary cover

*	470	336	200	-	10,650	1	1	83000 40 0
	470	336	250	-	12,000	1	1	83000 41 0

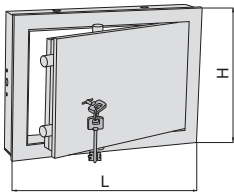

- Faceplate with key
- Two keys item 1.00101.00.2
- To be combined with item 83000.40/41

	420	300	10	2	2	1	19,400	1	1	83010 40 0
--	-----	-----	----	---	---	---	--------	---	---	-------------------

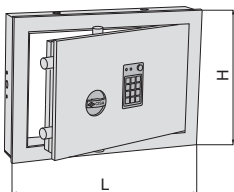

- Back-lit alphanumeric keypad
- Faceplate with electronic combinator
- Internal light
- To be combined with item 83000.40/41
- 1.5 V alkaline thin battery operation
- Laser welded sealing parts assembly
- SUPPLIED AS STANDARD:
- Power cable
- Shelf

*	420	300	10	2	2	1	18,300	1	1	83710 40 0
---	-----	-----	----	---	---	---	--------	---	---	-------------------



Technical features:

- 8 mm. thick steel doors with laser cut between the frame and door
- Nickel-plated steel anti-sawing rolling deadbolts (diameter 22 mm.)
- Seals are assembled through automated welding
- Special high-resistance anti-corrosion kiln painting
- Carbonitrided steel lock protection plate
- Lock and mechanisms are fixed directly onto the door

Supplied as standard:

- Shelves (where these are provided for)
- Installation instructions
- Instruction sheet

Type	Description	Prompt delivery	Outside dim.			Door thickness	Vertical bolts	Horizontal bolts	No. of shelves	Unit weight	Pieces	ITEM			
			L	H	P							Type	Dim.	Hand	Fin.

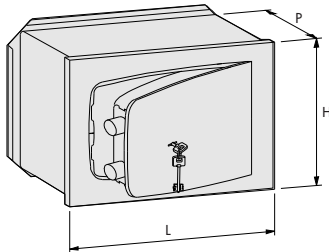

- Key only version
- 2 keys item 1.00100.00.2

*	310	190	145	8	2	1	9,400	1	1	8A010 20 0				
*	310	190	195	8	2	1	10,300	1	1	8A010 21 0				
*	360	240	145	8	2	1	12,650	1	1	8A010 30 0				
*	360	240	195	8	2	1	13,700	1	1	8A010 31 0				
*	420	300	195	8	2	1	18,100	1	1	8A010 40 0				
*	420	300	245	8	2	1	20,000	1	1	8A010 41 0				



Technical features:

- Lit keypad.
- 10 mm thick steel front (12 mm. for the 420x550 and 490x620 versions)
- Seals are assembled using tough welds
- Nickel-plated rolling steel deadbolts (diameter 22 mm)
- Special high-resistance anti-corrosion kiln painting
- Carbonitrided steel lock protection plate
- Lock and mechanisms are fixed directly onto the door of the safe
- Opening commands do not protrude when in the rest position

Supplied as standard:

- Power cable
- Shelves (where these are provided for)
- Use and maintenance instructions
- Installation instructions.

Certifications:

- Complies with the electromagnetic compatibility standard EN 55014-1 / 2: 2021

DGT Vision

Type	Description	Prompt delivery	Outside dim.			Door thickness	Vertical bolts	Horizontal bolts	No. of shelves	Unit weight	Pieces	ITEM			
			L	H	P							Type	Dim.	Hand	Fin.

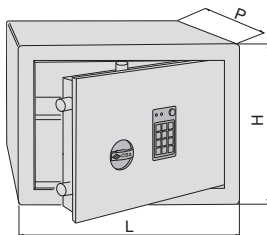

- Back-lit alphanumeric keypad
- Electronic combinator
- Internal light
- 1.5 V alkaline thin battery operation
- Removable door
- Laser welded sealing parts assembly
- Sound and visual indications
- Tamper-proof lock

*	360	240	300	10	2	1	28,200	1	1	82750 34 0
*	420	300	350	10	2	2	40,500	1	1	82750 43 0
	490	360	350	10	2	2	51,000	1	1	82750 53 0
	360	490	400	10	2	4	55,650	1	1	82750 74 0
	420	550	450	12	2	4	75,000	1	1	82750 85 0
	490	620	450	12	2	4	92,000	1	1	82750 95 0



Technical features:

- Lit keypad.
- 10 mm thick, steel front
- Seals are assembled using tough welds
- Nickel-plated rolling steel deadbolts (diameter 22 mm)
- Special, high-resistance anti-corrosion kiln painting
- Carbonitrided steel lock protection plate
- Lock and mechanisms are fixed directly onto the door of the safe.
- Opening commands do not protrude when in the rest position

Supplied as standard:

- Window sticker
- Power cable
- Shelves (where these are provided for)
- Instruction sheet
- Installation instructions

Certifications:

- Complies with the electromagnetic compatibility standard EN 55014-1 / 2: 2021

DGT Cash

Type	Description	Prompt delivery	Outside dim.			Door thickness	Vertical bolts	Horizontal bolts	No. of shelves	Unit weight	Pieces	ITEM			
			L	H	P							Type	Dim.	Hand	Fin.

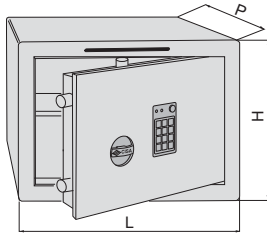

- Back-lit alphanumeric keypad
- Slot to introduce money or papers
- Opening delay programmable between 1 and 99 minutes
- Electronic combinator
- Internal light
- 1.5 V alkaline battery powered
- Removable door
- Laser welded sealing part assembly

			360	270	300	10		2	1	22,200	1	1	82751	35	0
			360	520	400	10	2	4	3	52,400	1	1	82751	75	0



Technical features:

- 10 mm. thick steel front (12 mm. for the 420x550 and 490x620 versions)
- Seals are assembled using tough welds
- Nickel-plated rolling steel deadbolts (diameter 22 mm.)
- Special high-resistance anti-corrosion kiln painting
- Carbonitrided steel lock protection plate
- Lock and mechanisms are fixed directly onto the door of the safe
- Opening commands do not protrude when in the rest position

Supplied as standard:

- Shelves (where these are provided for)
- Instruction sheet
- Installation instructions

Type	Description	Prompt delivery	Outside dim.			Door thickness	Vertical bolts	Horizontal bolts	No. of shelves	Unit weight	Pieces	ITEM			
			L	H	P							Type	Dim.	Hand Fin.	Pers. Spec.

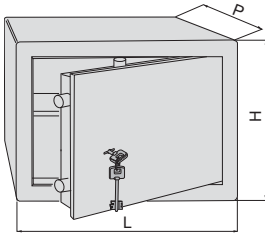

- Key only version
- Two keys item 1.00101.00.2

360	240	300	10	2	1	28,300	1	1 82050 34 0
420	300	350	10	2	2	40,900	1	1 82050 43 0
490	360	350	10	2	2	54,000	1	1 82050 53 0
360	490	400	10	2	4	54,900	1	1 82050 74 0
420	550	450	12	2	4	75,500	1	1 82050 85 0
490	620	450	12	2	4	92,000	1	1 82050 95 0



Technical features:

- 10 mm. thick steel front (12 mm. for the 420x550 and 490x620 versions)
- Seals are assembled using tough welds
- Nickel-plated rolling steel deadbolts (diameter 22 mm.)
- Special high-resistance anti-corrosion kiln painting
- Carbonitrided steel lock protection plate
- Lock and mechanisms are fixed directly onto the door of the safe.
- Opening commands do not protrude when in the rest position

Supplied as standard:

- Shelves (where these are provided for)
- Instruction sheet
- Installation instructions

Type	Description	Prompt delivery	Outside dim.			Door thickness	Vertical bolts	Horizontal bolts	No. of shelves	Unit weight	Pieces	ITEM			
			L	H	P							Type	Dim.	Hand.	Fin.

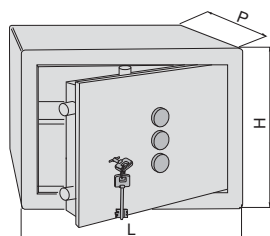

- Key and 3-knob combinator version
- Two keys item 1.00101.00.2

360	240	300	10	2	1	28,600	1	1	82250 34 0				
420	300	350	10	2	2	42,800	1	1	82250 43 0				
490	360	350	10	2	2	55,000	1	1	82250 53 0				
360	490	400	10	2	4	59,000	1	1	82250 74 0				
420	550	450	12	2	4	75,750	1	1	82250 85 0				
490	620	450	12	2	4	93,080	1	1	82250 95 0				

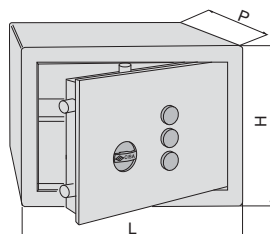

- 3-knob combinator only version

360	240	300	10	2	1	28,600	1	1	82450 34 0				
420	300	350	10	2	2	42,200	1	1	82450 43 0				
490	360	350	10	2	2	53,800	1	1	82450 53 0				
360	490	400	10	2	4	58,700	1	1	82450 74 0				
420	550	450	12	2	4	75,600	1	1	82450 85 0				
490	620	450	12	2	4	92,500	1	1	82450 95 0				



Technical features:

- 8 mm thick, steel front
- Seals are assembled using tough welds
- Nickel-plated rolling steel deadbolts (diameter 22 mm)
- Special, high-resistance anti-corrosion kiln painting
- Carbonitrided steel lock protection plate
- Lock and mechanisms are fixed directly onto the door of the safe.

Supplied as standard:

- Shelves (where these are provided for)
- Instruction sheet
- Installation instructions

Type	Description	Prompt delivery	Outside dim.			Door thickness	Vertical bolts	Horizontal bolts	No. of shelves	Unit weight	Pieces	ITEM			
			L	H	P							Type	Dim.	Hand Fin.	Pers. Spec.

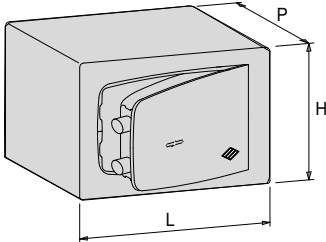

- Key only version
- 2 keys item 1.00100.00.2

310	190	250	8	2	-	13,200	1	1	8A050 23 0
360	240	300	8	2	1	19,600	1	1	8A050 34 0
420	300	350	8	2	1	27,350	1	1	8A050 43 0

**Technical features:**

- Door laser cut
- Audit trail can be stored to an SD card
- Automatic interior lighting
- Easy-to-read ADA-compliant keypad
- 7-digit led display
- Size to place a 15" laptop inside
- 2-level service Master Code
- Motorised lock
- Emergency mechanical override

Supplied as standard:

- 4x AARL6 batteries
- Interior carpet
- Emergency key
- Interior lighting

On request:

- Internal power socket
- Left hand opening
- AP3 S protected duplication emergency key

Finishes:

- Supplied as standard:
Dark grey "Grafite" (RAL 7015)
- On request:
Light grey "Silicon" (RAL 7032)

Certifications:

- Complies with the electromagnetic compatibility standard EN 55014-1 / 2: 2021 and electrical safety EN60335-1:2012 + A2:2019

CISA eSIGNO

Type	Description	Prompt delivery	Outside dim.			Door thickness	Vertical bolts	Horizontal bolts	No. of shelves	Unit weight	Pieces	ITEM			
			L	H	P							Type	Dim.	Hand	Fin.

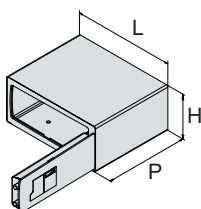

- C2000 cylinder for mechanical emergency override
- Finish: silica gray

DX	430	190	350	5	2	-	11,600	1	1	AOL02	01	0		
SX	430	190	350	5	2	-	11,600	1	1	AOL02	01	4		

- C2000 cylinder for mechanical emergency override
- Finish: graphite gray

DX	430	190	350	5	2	-	11,600	1	1	AOL02	01	0	93	
SX	430	190	350	5	2	-	11,600	1	1	AOL02	01	4	93	

- C2000 cylinder for mechanical emergency override
- Finish: silica gray
- Power supply socket

DX	430	190	350	5	2	-	11,600	1	1	AOL02	31	0		
SX	430	190	350	5	2	-	11,600	1	1	AOL02	31	4		

- C2000 cylinder for mechanical emergency override
- Finish: graphite gray
- Power supply socket

DX	430	190	350	5	2	-	11,600	1	1	AOL02	31	0	93	
SX	430	190	350	5	2	-	11,600	1	1	AOL02	31	4	93	

- AP3 S cylinder for mechanical emergency override
- Finish: silica gray

DX	430	190	350	5	2	-	11,600	1	1	AOL01	01	0		
SX	430	190	350	5	2	-	11,600	1	1	AOL01	01	4		

- AP3 S cylinder for mechanical emergency override
- Finish: graphite gray



DX	430	190	350	5	2	-	11,600	1	1	AOL01	01	0	93	
SX	430	190	350	5	2	-	11,600	1	1	AOL01	01	4	93	

- AP3 S cylinder for mechanical emergency override
- Finish: silica gray
- Power supply socket



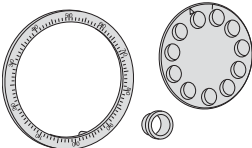
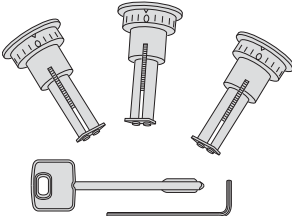
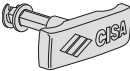

DX	430	190	350	5	2	-	11,600	1	1	AOL01	31	0		
SX	430	190	350	5	2	-	11,600	1	1	AOL01	31	4		

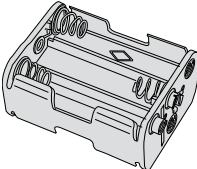
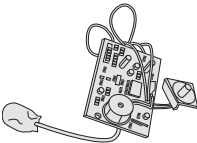
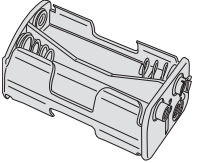
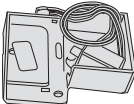
- AP3 S cylinder for mechanical emergency override
- Finish: graphite gray
- Power supply socket

DX	430	190	350	5	2	-	11,600	1	1	AOL01	31	0	93	
SX	430	190	350	5	2	-	11,600	1	1	AOL01	31	4	93	

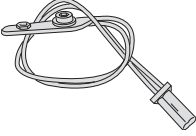
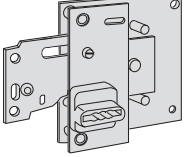
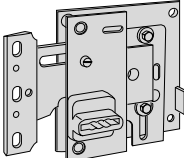

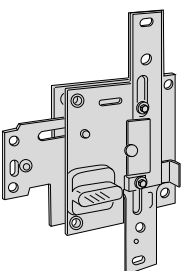
Type	Description	For series/item	Unit weight Kg	Pieces	ITEM				
					Type	Dim.	Hand	Fin.	Pers. Spec.
	• Combinator dial and plate	1 58010 00 0	0,200	1	1	07095 00 0			
	• Set of 3 knobs and combinator changing key	1 58011 00 0	0,150	1	1	07108 00 0			
	• Lock operating knob	1 57424 30 1, 1 57429 30 1	0,160	1	1	07109 00 0			
	• Changing key for safes with combinator	1 58010 00 0, 82310, 82350, 82510, 82550	0,020	1	1	07109 01 0			
	• Changing key set for safes with 3-knob combinator	1 58011 00 0, 82210, 82250, 82410, 82450	0,040	0	1	07109 03 0			
	• 9V battery holder	82610, 82650	0,030	1	1	07114 00 0			
	• Electronic board 6V master code		0,035	1	1	07114 12 0			
	• Electronic board for Digit Vision safe	82710, 82750	0,035	1	1	07114 15 0			
	• 6V battery holder	82610, 82650, 82710, 82750	0,030	1	1	07114 05 0			
	• 6V solenoid plate group		0,250	0	1	07114 06 0			

Type	Description	For series/item	Unit weight Pieces	ITEM				
				Type	Dim.	Hand	Fin.	Pers. Spec.
	<ul style="list-style-type: none"> Kit to convert from safes Digit to safes Digit Vision Master Code 		0,370 1	1	07114	11	0	
	<ul style="list-style-type: none"> Key pad for Digit Vision safe 		0,005 1	1	07114	16	0	
	<ul style="list-style-type: none"> Kit to convert from safes Digit to safes Digit Vision 		0,370 1	1	07114	17	0	
	<ul style="list-style-type: none"> Lacquered steel support for furniture safes 	1 82050 74 0, 1 82250 74 0, 1 82350 74 0, 1 82450 74 0, 1 82550 74 0, 1 82650 74 0	16,650 1	1	07125	00	0	
	<ul style="list-style-type: none"> Lacquered steel support for furniture safes 	1 82050 85 0, 1 82050 95 0, 1 82250 85 0, 1 82250 95 0, 1 82350 85 0, 1 82350 95 0, 1 82450 85 0, 1 82450 95 0, 1 82550 85 0, 1 82550 95 0	17,950 1	1	07125	01	0	
	<ul style="list-style-type: none"> 9V external power supply cable 	82610, 82650, 82651	0,030 1	1	07430	31	0	

Type	Description	For series/item	Unit weight Kg	Pieces	ITEM				
					Type	Dim.	Hand	Fin.	Pers. Spec.
	<ul style="list-style-type: none"> • 6V external power supply cable 	82710, 82750, 82751	0,030	1	1	07430	32	0	
	<ul style="list-style-type: none"> • Zinc plated steel lock • One locking point • Two keys item 1.00101.00.2 • FOR KEY-OPERATED SAFES: item 1.82010.10.0 item 1.82010.11.0 		0,426	1	1	57409	30	1	
	<ul style="list-style-type: none"> • Zinc plated steel lock • One locking point • Two keys item 1.00101.00.2 • FOR SAFES OPERATED EITHER BY KEY ONLY OR KEY AND MECHANICAL COMBINATOR: Series 82010.20 ÷ 32 Series 82050.34 Series 82210.20 ÷ 32 Series 82250.34 Series 82310.30 ÷ 32 Series 82350.34 		0,460	1	1	57411	30	1	
	<ul style="list-style-type: none"> • Zinc plated steel lock • One locking point • Two keys item 1.00101.00.2 • FOR 1 STAR SAFES OPERATED BY KEY ONLY: Series 8A010.20 ÷ 41 		0,460	1	1	57411	31	1	
	<ul style="list-style-type: none"> • Zinc plated steel lock • Three locking points • Two keys item 1.00101.00.2 • FOR SAFES OPERATED EITHER BY KEY ONLY OR KEY AND MECHANICAL COMBINATOR: Series 82010.40 ÷ 92 Series 82050.43 ÷ 95 Series 82210.40 ÷ 92 Series 82250.43 ÷ 95 Series 82310.40 ÷ 92 Series 82350.43 ÷ 95 Series 83010.40 		0,620	1	1	57416	30	1	
	<ul style="list-style-type: none"> • Zinc plated steel lock • Three locking points • Two keys item 1.00101.00.2 • FOR 1 STAR SAFES OPERATED BY KEY ONLY: Series 8A010.50/51 		0,620	1	1	57416	31	1	

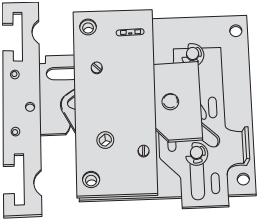
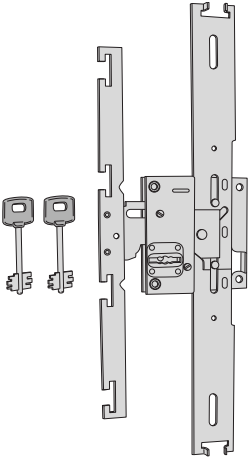
Type	Description	For series/item	Unit weight Pieces	ITEM				
				Type	Dim.	Hand	Fin.	Pers. Spec.
	<ul style="list-style-type: none"> • Zinc plated single throw steel lock • Three locking points • FOR SAFES OPERATED EITHER BY MECHANICAL OR ELECTRONICAL COMBINATOR: Series 82410.40 ÷ 92 Series 82450.43 ÷ 95 Series 82510.40 ÷ 92 Series 82550.43 ÷ 95 Series 82610.40 ÷ 72 Series 82650.43 ÷ 74 Series 83610.40 		0,500	1	1	57424	30	1
	<ul style="list-style-type: none"> • Zinc plated single throw steel lock • One locking point • FOR SAFES OPERATED EITHER BY MECHANICAL OR ELECTRONICAL COMBINATOR: Series 82410.20 ÷ 32 Series 82450.34 Series 82510.30 ÷ 32 Series 82550.34 Series 82610.30 ÷ 32 Series 82650.34 		0,400	1	1	57429	30	1
	<ul style="list-style-type: none"> • Combinator dial 	82310, 82315, 82350, 82510, 82515, 82550	0,400	1	1	58010	00	0
	<ul style="list-style-type: none"> • 3-knob combinator 	82210, 82250, 82410, 82450	0,430	1	1	58011	00	0
	<ul style="list-style-type: none"> • Steel lock with zinc coating • One locking point • Two keys item 1.00101.00.2 • Suitable for safes with turning deadbolts 	1 82010 10 0, 1 82010 11 0, 1 82010 20 0, 1 82010 21 0, 1 82210 20 0, 1 82210 21 0	0,426	1	1	87409	30	1
	<ul style="list-style-type: none"> • Steel lock with zinc coating • Three locking points • Two keys item 1.00101.00.2 • Suitable for safes with turning deadbolts 	1 82010 40 0, 1 82010 41 0, 1 82010 42 0, 1 82050 43 0, 1 82210 40 0, 1 82210 41 0, 1 82210 42 0, 1 82250 43 0	0,426	1	1	87412	30	1
	<ul style="list-style-type: none"> • Steel lock with zinc coating • Three locking points • Two keys item 1.00101.00.2 • Suitable for safes with turning deadbolts 	1 82010 50 0, 1 82010 51 0, 1 82010 52 0, 1 82050 53 0	0,426	1	1	87414	30	1

Type	Description	For series/item	Unit weight Kg	Pieces	ITEM													
					Type	Dim.	Hand	Fin.	Pers. Spec.									
	<ul style="list-style-type: none"> • Steel lock with zinc coating • One locking point • Suitable for safes with turning deadbolts 	1 82410 20 0,	0,426	1	1	B7411	30	1										
		1 82410 21 0,																
		1 82410 30 0,																
		1 82410 31 0,																
		1 82410 32 0,																
		1 82450 34 0,																
		1 82710 30 0,																
		1 82710 31 0,																
		1 82710 32 0,																
		1 82750 34 0,																
		1 82751 35 0																
										<ul style="list-style-type: none"> • Steel lock with zinc coating • Three locking points • Suitable for safes with turning deadbolts 	1 82410 50 0,	0,426	1	1	B7415	30	1	
											1 82410 51 0,							
1 82410 52 0,																		
1 82450 53 0,																		
1 82710 50 0,																		
1 82710 51 0,																		
1 82710 52 0,																		
1 82750 53 0																		
	<ul style="list-style-type: none"> • Steel lock with zinc coating • Three locking points • Suitable for safes with turning deadbolts 	1 82210 41 0,	0,426	1	1	B7413	30	1										
		1 82410 40 0,																
		1 82410 42 0,																
		1 82450 43 0,																
		1 82710 40 0,																
		1 82710 41 0,																
		1 82710 42 0,																
		1 82750 43 0																
	<ul style="list-style-type: none"> • Steel lock with zinc coating • Three locking points • Two keys item 1.00101.00.2 • Suitable for safes with turning deadbolts 	1 82010 70 0,	0,426	1	1	B7424	30	1										
		1 82010 71 0,																
		1 82010 72 0,																
		1 82050 74 0,																
		1 82210 70 0,																
		1 82210 71 0,																
		1 82210 72 0,																
		1 82250 74 0																
										<ul style="list-style-type: none"> • Steel lock with zinc coating • Three locking points • Two keys item 1.00101.00.2 • Suitable for safes with turning deadbolts 	1 82010 80 0,	0,426	1	1	B7426	30	1	
											1 82010 81 0,							
											1 82010 82 0,							
											1 82050 85 0,							
											1 82210 80 0,							
1 82210 81 0,																		
1 82210 82 0,																		
1 82250 85 0																		
	<ul style="list-style-type: none"> • Steel lock with zinc coating • Three locking points • Two keys item 1.00101.00.2 • Suitable for safes with turning deadbolts 	1 82010 90 0,	0,426	1	1	B7428	30	1										
		1 82010 91 0,																
		1 82010 92 0,																
		1 82050 95 0,																
		1 82210 90 0,																
		1 82210 91 0,																
		1 82210 92 0,																
1 82250 95 0																		

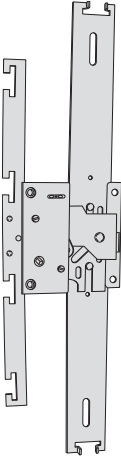
Type	Description	For series/item	 Unit weight Kg	 Pieces	ITEM					
					Type	Dim.	Hand	Fin.	Pers.	Spec.
	<ul style="list-style-type: none"> • Steel lock with zinc coating • Three locking points • Suitable for safes with turning deadbolts 	1 82410 70 0,	0,426	1	1	B7425	30	1		
		1 82410 71 0,								
		1 82410 72 0,								
		1 82450 74 0,								
		1 82710 70 0,								
		1 82710 71 0,								
		1 82710 72 0,								
		1 82750 74 0,								
		1 82751 75 0								
		1 82410 90 0,	0,426	1	1	B7429	30	1		
		1 82410 91 0,								
		1 82410 92 0,								
		1 82450 95 0,								
1 82710 90 0,										
1 82710 91 0,										
1 82710 92 0,										
1 82750 95 0,										
1 82750 95 0										

Type	Description	For series/item	 Unit weight	 Pieces	ITEM Type Dim. Hand Fin. Pers. Spec.	
------	-------------	-----------------	--	---	---	--

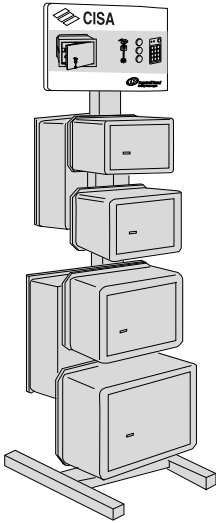

- DISPLAY FOR WALL SAFES
- WITH ADJUSTABLE SUPPORTS
- FOR WALL AND STANDING SAFES

15,000 1 1 06610 50 0

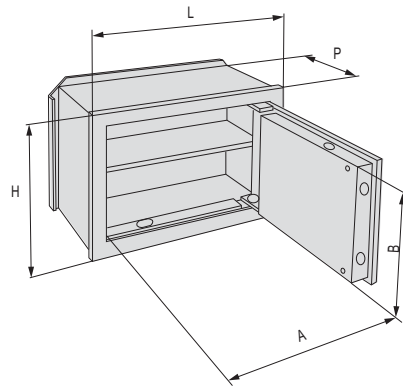

ITEM	DIMENSIONS (mm)										Door/bolt	Shelves	Weight Kg			
	Outside			Inside			A		B					Rear outside		
	L	H	P	L	H	P										
1-8A010-20	310	190	150	292	172	100	192	115	340	210	2	1	12,9			
1-8A010-21	"	"	200	"	"	150	192	115	340	210	2	1	13,6			
1-8A010-30	360	240	150	342	222	100	242	165	390	260	2	1	17,5			
1-8A010-31	"	"	200	"	"	150	242	165	390	260	2	1	18,4			
1-8A010-40	420	300	200	402	282	150	302	225	450	320	2	1	24,7			
1-8A010-41	"	"	250	"	"	200	302	225	450	320	2	1	25,8			
1-82010-10	260	170	150	242	152	100	142	95	290	190	2	-	7,3			
1-82010-11	"	"	200	"	"	150	142	95	290	190	2	-	8,0			
1-82010-20	1-82210-20	1-82410-20	310	190	150	292	172	100	192	115	340	210	2	1	12,9	
1-82010-21	1-82210-21	1-82410-21	"	"	200	"	"	150	192	115	340	210	2	1	13,6	
1-82010-22	1-82210-22	1-82410-22	"	"	250	"	"	200	192	115	340	210	2	1	14,4	
1-82010-30	1-82210-30	1-82410-30	1-82710-30	360	240	150	342	222	100	242	165	390	260	2	1	17,5
1-82010-31	1-82210-31	1-82410-31	1-82710-31	"	"	200	"	"	150	242	165	390	260	2	1	18,4
1-82010-32	1-82210-32	1-82410-32	1-82710-32	"	"	250	"	"	200	242	165	390	260	2	1	19,3
1-82010-40	1-82210-40	1-82410-40	1-82710-40	420	300	200	402	282	150	302	225	450	320	4+2	1	24,7
1-82010-41	1-82210-41	1-82410-41	1-82710-41	"	"	250	"	"	200	302	225	450	320	4+2	1	25,8
1-82010-42	1-82210-42	1-82410-42	1-82710-42	"	"	300	"	"	250	302	225	450	320	4+2	1	26,9
1-82010-50	1-82210-50	1-82410-50	1-82710-50	490	360	200	472	342	150	372	285	520	380	4+2	1	33,1
1-82010-51	1-82210-51	1-82410-51	1-82710-51	"	"	250	"	"	200	372	285	520	380	4+2	1	34,4
1-82010-52	1-82210-52	1-82410-52	1-82710-52	"	"	300	"	"	250	372	285	520	380	4+2	1	35,7
1-82010-70	1-82210-70	1-82410-70	1-82710-70	360	490	200	342	472	150	242	415	390	510	4+2	2	33,1
1-82010-71	1-82210-71	1-82410-71	1-82710-71	"	"	250	"	"	200	242	415	390	510	4+2	2	34,4
1-82010-72	1-82210-72	1-82410-72	1-82710-72	"	"	300	"	"	250	242	415	390	510	4+2	2	35,7
1-82010-80	1-82210-80	1-82410-80	1-82710-80	420	550	200	402	532	150	302	475	450	570	4+2	2	39,7
1-82010-81	1-82210-81	1-82410-81	1-82710-81	"	"	250	"	"	200	302	475	450	570	4+2	2	41,3
1-82010-82	1-82210-82	1-82410-82	1-82710-82	"	"	300	"	"	250	302	475	450	570	4+2	2	42,9
1-82010-90	1-82210-90	1-82410-90	1-82710-90	490	620	200	472	602	150	372	545	520	640	4+2	2	51,0
1-82010-91	1-82210-91	1-82410-91	1-82710-91	"	"	250	"	"	200	372	545	520	640	4+2	2	52,8
1-82010-92	1-82210-92	1-82410-92	1-82710-92	"	"	300	"	"	250	372	545	520	640	4+2	2	54,6

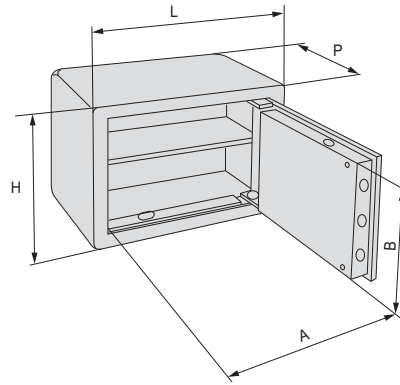

ITEM	DIMENSIONS (mm)								Deadbolt Shelves	Weight Kg				
	Outside			Inside			A B							
	L	H	P	L	H	P	A	B						
1-8A050-23	310	190	250	300	180	195	192	115	2	13,2				
1-8A050-34	420	300	350	410	290	295	302	225	2	19,6				
1-8A050-43	490	360	350	480	350	295	372	285	2	22,5				
1-82050-34	1-82250-34	1-82450-34	1-82750-34	360	240	300	350	230	245	242	165	2	1	25,5
1-82050-43	1-82250-43	1-82450-43	1-82750-43	420	300	350	410	290	295	302	225	4+2	1	38,7
1-82050-53	1-82250-53	1-82450-53	1-82750-53	490	360	350	480	350	295	372	285	4+2	1	49,5
1-82050-74	1-82250-74	1-82450-74	1-82750-74	360	490	400	350	480	345	242	415	4+2	3	54,2
1-82050-85	1-82250-85	1-82450-85	1-82750-85	420	550	450	410	540	395	302	475	4+2	3	69,4
1-82050-95	1-82250-95	1-82450-95	1-82750-95	490	620	450	480	610	395	372	545	4+2	3	84,5
			1-82751-34	360	240	300	350	230	245	242	165	2	1	27,2
			1-82751-74	360	490	400	350	480	345	242	415	4+2	3	52,4
			1-AOL01-01	430	190	350	427	185	295	131	365	1		11,6
			1-AOL01-31	430	190	350	427	185	295	131	365	1		11,6
			1-AOL02-01	430	190	350	427	185	295	131	365	1		11,6
			1-AOL02-31	430	190	350	427	185	295	131	365	1		11,6

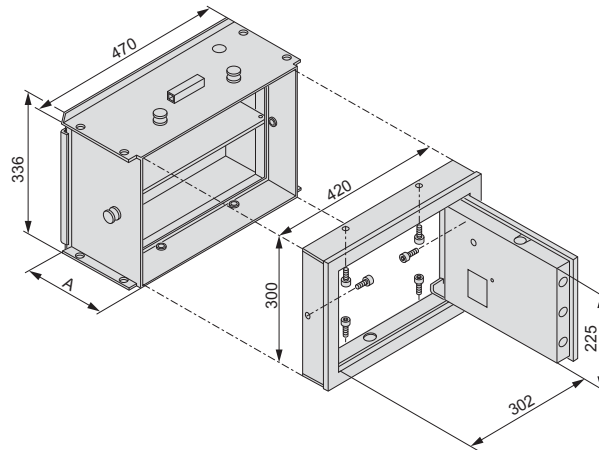

	DIMENSIONS (mm)								Deadbolt Shelves	Weight Kg			
	Outside			Inside			Rear outside						
	L	H	P	L	H	P	A	B					
SAFES COMPARTMENT													
1-83000-40	470	336	200	420	300	200	-	-	450	320	-	-	15,2
1-83000-41	"	"	250	"	"	250	-	-	"	"	-	-	16,3
FRONTAL													
1-83010-40	420	300	-	-	-	-	302	225	-	-	2+2	-	19,4
1-83710-40	"	"	-	-	-	-	"	"	-	-	2+2	-	19,7



Keying kits



Keying components for cylinders and padlocks	592
Key components	593
Keying components for cylinders and padlocks	598

Assembling tools for cylinders and padlocks	604
Keying components for double-bit key locks	607

CYLINDERS AND PADLOCKS SUPPLIED IN UNASSEMBLED VERSIONS

Cylinders and padlocks are available in **UNASSEMBLED** versions :

- **"UNASSEMBLED"** (completely unassembled)

N.B. In both cases, keys, pins, drivers, springs, pin hole plugs, circlips, are to be ordered separately

CYLINDERS	UNASSEMBLED 91				
	C2000	C3000 C3000S	Astral	Astral Tekno Pro	AsixP8
<ul style="list-style-type: none"> • Euro profile double cylinders • Euro profile single cylinders • Euro profile thumb turn cylinders • Rim cylinders, cam locks, furniture cylinders • Rim cylinder set • Hardened steel padlock cylinders 	• • • • • -	• • • • • •	• • • • • •	• • • • • •	• • • • • •

BRASS PADLOCKS	STANDARD	LIM
<ul style="list-style-type: none"> • 22010-30/40 • 22010-50/60 	• •	• See PP

HARDENED STEEL PADLOCKS	
<p>Hardened steel padlocks in UNASSEMBLED version are supplied without cylinder and without the cylinder and padlock drill resistant plate When ordering the padlock cylinder you must specify separately the relevant padlock drill resistant plate (the cylinder drill resistant plate is supplied as standard).</p>	
<ul style="list-style-type: none"> • 28050-55/56/57, 28350-62, 28050-70/71/72, 28350-73, 28550-66/67/75/84/85 	•

Type	Description	For series/item	Unit weight 	Pieces 	ITEM				
					Type	Dim.	Hand	Fin.	Pers. Spec.

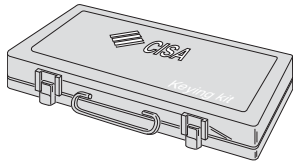

- Assembly kit for:
European profile cylinders
Rim cylinders
Padlocks item 1.22010.50/60 and 1.26020.50/60
- Pins diameter 2.8 mm.

0G300, 3,370 1 1 07550 01 0
08300, 08700

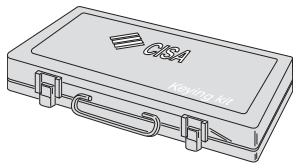

























- Assembly kit for:
European profile cylinders
Rim cylinders
- Pins diameter 2.5 mm.

























0N300, 0E300 3,170 1 1 07550 13 0
0A3S1, 0M3T1
0P3S1, 0Q311





















MAP OF KEYING KITS COMPONENTS ITEM 1.07550.01.0



















PASTIGLIA WAFER — 1 07555-01	PASTIGLIA AGGIUNTIVA ADDITIONAL WAFER — 1 07555-11	PERNO / PIN used for: incr. 1 series .65 incr. 1 series .44 07551-01	PERNO / PIN used for: incr. 2 series .65 incr. 2 series .44 07551-02	PERNO / PIN used for: incr. 3 series .65 incr. 4 series .44 07551-03	PERNO / PIN used for: incr. 4 series .65 incr. 4 series .44 07551-04	PERNO / PIN used for: incr. 5 series .65 incr. 7 series .44 07551-05	PERNO / PIN used for: incr. 6 series .65 incr. 6 series .44 07551-06
PASTIGLIA WAFER — 2 07555-02	PASTIGLIA AGGIUNTIVA ADDITIONAL WAFER — 2 07555-12	TAPPO / PLUG 07557-11	PERNO / PIN used for: incr. 2 series .44 07551-41	PERNO / PIN used for: incr. 3 series .44 07551-42	PERNO / PIN used for: incr. 5 series .44 07551-43	PERNO / PIN used for: incr. 6 series .44 07551-44	PERNO / PIN used for: incr. 8 series .44 07551-45
PASTIGLIA WAFER 3 07555-03	PASTIGLIA AGGIUNTIVA ADDITIONAL WAFER 3 07555-13	CONTROPERNO DRIVER 1 07552-01	CONTROPERNO DRIVER 2 07552-02	CONTROPERNO DRIVER 3 07552-03	SPINA BLOCCA CILINDRETTO PLUG RETAINING PIN Per/For: 22010-50 07556-05	SPINA BLOCCA CILINDRETTO PLUG RETAINING PIN Per/For: 22010-60 07556-06	MOLLA SPRING Per/For: -02500 -02559 07554-01
PASTIGLIA WAFER 4 07555-04	PASTIGLIA AGGIUNTIVA ADDITIONAL WAFER 4 07555-14	CONTROPERNO MUSHROOM DRIVER 1 07553-01	CONTROPERNO MUSHROOM DRIVER 2 07553-02	CONTROPERNO MUSHROOM DRIVER 3 07553-03	TAPPO PIN HOLE PLUG Per/For: 22010-50 07557-01	TAPPO PIN HOLE PLUG Per/For: 22010-60 07557-02	MOLLA SPRING Per/For:-02552 -02550 -02555 -02332 07554-02
PASTIGLIA WAFER 5 07555-05	GHIERA / CIRCLIP 07558-01	GHIERA / CIRCLIP 07558-02	MOLLA SPRING Per / For -08510/0G300 -22010-50 -22010-60 07554-03	GHIERA / CIRCLIP 07558-02	MAPPA KIT CIFRATURA / KEYNG KIT 07550-01-0 PER LUCCHETTI DA 50 E 60 mm, CILINDRI DA INFILARE E APPLICARE. FOR 50 AND 60 mm PADLOCKS, MORTISE AND RIM CYLINDERS.		

MAP OF KEYING KITS COMPONENTS ITEM 1.07550.13.0

	PERNO INFERIORE LOWER PIN  07571-71	PERNO INFERIORE LOWER PIN  07571-72	PERNO INFERIORE LOWER PIN  07571-73	PERNO INFERIORE LOWER PIN  07571-74	PERNO INFERIORE LOWER PIN  07571-77	PERNO INFERIORE LOWER PIN  07571-78	
CONTROPERNO DRIVER  SALTO 1-2 07572-96		CONTROPERNO DRIVER  SALTO 3-4 07572-87		CONTROPERNO DRIVER  SALTO 5-6 07572-89			PERNO SUPERIORE UPPER PIN  07571-79
CONTROPERNO DRIVER  SALTO 1-2 07572-72	CONTROPERNO DRIVER  SALTO 3-4 07572-77	CONTROPERNO DRIVER  SALTO 5-6 07572-78			PERNO LATERALE LATERAL PIN  07571-91	GR. PERNO BREVETTO PATENT PIN GROUP  07571-95	GR. CONTROP. BREV. PATENTED DRIVER GROUP  07572-97
	CONTROPERNO BKP BKP DRIVER  SALTO 1 07572-91	CONTROPERNO BKP BKP DRIVER  SALTO 2-3 07572-92		MOLLA BRONZO BRONZE SPRING  per / for PROFILO EUROPEO EUROPEAN PROFILE 07554-72	MOLLA / SPRING  per / for CILINDRI VARI VARIOUS CYLINDER 07554-73		MOLLA ACCIAIO STEEL SPRING  per / for PROFILO EUROPEO EUROPEAN PROFILE 07554-92
		GHIERA / CIRCLIP EURO / CLL CYLINDER  07558-05	GHIERA / CIRCLIP EURO / CLL CYLINDER  07558-05	GHIERA / CIRCLIP EURO / CLL CYLINDER  07558-05	GHIERA / CIRCLIP EURO / CLL CYLINDER  07558-01	AP4	

PERNO INFERIORE LOWER PIN  07571-70	PERNO INFERIORE LOWER PIN  07571-71	PERNO INFERIORE LOWER PIN  07571-72	PERNO INFERIORE LOWER PIN  07571-73	PERNO INFERIORE LOWER PIN  07571-74	PERNO INFERIORE LOWER PIN  07571-77	PERNO INFERIORE LOWER PIN  07571-78	PERNO INFERIORE LOWER PIN  07571-80
	CONTROPERNO DRIVER  SALTO 0-1-2 07572-84		CONTROPERNO DRIVER  SALTO 3-4-5 07572-88		CONTROPERNO DRIVER  SALTO 6-7 07572-63		
CONTROPERNO DRIVER  SALTO 0-1 07572-72	CONTROPERNO DRIVER  SALTO 2-3 07572-77	CONTROPERNO DRIVER  SALTO 4-5 07572-78		CONTROPERNO DRIVER  SALTO 6-7 07572-76			
CONTROPERNO BKP BKP DRIVER  SALTO 0-1 07572-90	CONTROPERNO BKP BKP DRIVER  SALTO 2-3 07572-91	CONTROPERNO BKP BKP DRIVER  SALTO 4-5 07572-92		MOLLA BRONZO BRONZE SPRING  per / for PROFILO EUROPEO EUROPEAN PROFILE 07554-72	MOLLA / SPRING  per / for CILINDRI VARI VARIOUS CYLINDER 07554-73		MOLLA ACCIAIO STEEL SPRING  per / for PROFILO EUROPEO EUROPEAN PROFILE 07554-92
		GHIERA / CIRCLIP EURO / CLL CYLINDER  07558-05	GHIERA / CIRCLIP EURO / CLL CYLINDER  07558-05	GHIERA / CIRCLIP EURO / CLL CYLINDER  07558-05	GHIERA / CIRCLIP EURO / CLL CYLINDER  07558-01	C3000	



























	PERNO INFERIORE LOWER PIN  07571-71	PERNO INFERIORE LOWER PIN  07571-72	PERNO INFERIORE LOWER PIN  07571-73	PERNO INFERIORE LOWER PIN  07571-74	PERNO INFERIORE LOWER PIN  07571-77	PERNO INFERIORE LOWER PIN  07571-78	
		CONTROPERNO DRIVER  SALTO 1-2 07572-87		CONTROPERNO DRIVER  SALTO 3-4 07572-89	CONTROPERNO DRIVER  SALTO 5-6 07572-63		PERNO SUPERIORE UPPER PIN  07571-79
					PERNO LATERALE LATERAL PIN  07571-91	GR. PERNO BREVETTO PATENT PIN GROUP  07571-95	GR. CONTROP. BREV. PATENTED DRIVER GROUP  07572-97
	CONTROPERNO BKP BKP DRIVER  SALTO 1 07572-91	CONTROPERNO BKP BKP DRIVER  SALTO 2-3 07572-92	MOLLA BRONZO BRONZE SPRING  per / for CILINDRI SIGILLO SNAP RESISTANT 07554-71			MOLLA ACCIAIO STEEL SPRING  per / for CILINDRI SIGILLO SNAP RESISTANT 07554-91	
		GHIERA / CIRCLIP EURO / CLL CYLINDER  07558-05	GHIERA / CIRCLIP EURO / CLL CYLINDER  07558-05	GHIERA / CIRCLIP EURO / CLL CYLINDER  07558-05	AP4S		

















PERNO INFERIORE LOWER PIN  07571-70	PERNO INFERIORE LOWER PIN  07571-71	PERNO INFERIORE LOWER PIN  07571-72	PERNO INFERIORE LOWER PIN  07571-73	PERNO INFERIORE LOWER PIN  07571-74	PERNO INFERIORE LOWER PIN  07571-77	PERNO INFERIORE LOWER PIN  07571-78	PERNO INFERIORE LOWER PIN  07571-80
			CONTROPERNO DRIVER  SALTO 0-1-2 07572-88	CONTROPERNO DRIVER  SALTO 3-4 07572-89	CONTROPERNO DRIVER  SALTO 5-6 07572-63	CONTROPERNO DRIVER  SALTO 7 07572-64	
	CONTROPERNO BKP BKP DRIVER  SALTO 0-1 07572-91	CONTROPERNO BKP BKP DRIVER  SALTO 2 07572-92	MOLLA BRONZO BRONZE SPRING  per / for CILINDRI SIGILLO SNAP RESISTANT 07554-71			MOLLA ACCIAIO STEEL SPRING  per / for CILINDRI SIGILLO SNAP RESISTANT 07554-91	
		GHIERA / CIRCLIP EURO / CLL CYLINDER  07558-05	GHIERA / CIRCLIP EURO / CLL CYLINDER  07558-05	GHIERA / CIRCLIP EURO / CLL CYLINDER  07558-05	C3000S		

MAP OF KEYING KITS COMPONENTS ITEM 1.07550.13.0



	PERNO INFERIORE LOWER PIN 07571-71	PERNO INFERIORE LOWER PIN 07571-72	PERNO INFERIORE LOWER PIN 07571-73	PERNO INFERIORE LOWER PIN 07571-74	PERNO INFERIORE LOWER PIN 07571-77	PERNO INFERIORE LOWER PIN 07571-78	
CONTROPERNO DRIVER SALTO 1-2 07572-96		CONTROPERNO DRIVER SALTO 3-4 07572-87	CONTROPERNO DRIVER POSIZIONE TACCA 07572-88	CONTROPERNO DRIVER SALTO 5-6 07572-89			PERNO SUPERIORE UPPER PIN 07571-79
CONTROPERNO DRIVER SALTO 1-2 07572-72	CONTROPERNO DRIVER SALTO 3-4 07572-77	CONTROPERNO DRIVER SALTO 5-6 07572-78	CONTROPERNO DRIVER POSIZIONE TACCA 07572-75				
	CONTROPERNO BKP BKP DRIVER SALTO 1 07572-91	CONTROPERNO BKP BKP DRIVER SALTO 2-3 07572-92		MOLLA BRONZO BRONZE SPRING per / for PROFILO EUROPEO EUROPEAN PROFILE 07554-72	MOLLA / SPRING per / for CILINDRI VARI VARIOUS CYLINDER 07554-73		MOLLA ACCIAIO STEEL SPRING per / for PROFILO EUROPEO EUROPEAN PROFILE 07554-92
PERNO LATERALE LATERAL PIN 07571-93	PERNO LATERALE LATERAL PIN 07571-94	GHIERA / CIRCLIP EURO / CLL CYLINDER 07558-05	GHIERA / CIRCLIP EURO / CLL CYLINDER 07558-05	GHIERA / CIRCLIP EURO / CLL CYLINDER 07558-05	GHIERA / CIRCLIP RIM CYLINDER 07558-01	ASTRAL TEKNO	

	PERNO INFERIORE LOWER PIN 07571-71	PERNO INFERIORE LOWER PIN 07571-72	PERNO INFERIORE LOWER PIN 07571-73	PERNO INFERIORE LOWER PIN 07571-74	PERNO INFERIORE LOWER PIN 07571-77	PERNO INFERIORE LOWER PIN 07571-78	
	CONTROPERNO DRIVER SALTO 1-2-3 07572-84	CONTROPERNO DRIVER SALTO 4-5-6 TUTTI I SALTI IN 6 ^a POSIZ. 07572-87					PERNO SUPERIORE UPPER PIN 07571-79
CONTROPERNO DRIVER SALTO 1-2 07572-72	CONTROPERNO DRIVER SALTO 3-4 07572-77	CONTROPERNO DRIVER SALTO 5-6 07572-78					
	CONTROPERNO BKP BKP DRIVER SALTO 1 07572-91	CONTROPERNO BKP BKP DRIVER SALTO 2-3 07572-92		MOLLA BRONZO BRONZE SPRING per / for PROFILO EUROPEO EUROPEAN PROFILE 07554-72	MOLLA / SPRING per / for CILINDRI VARI VARIOUS CYLINDER 07554-73		MOLLA ACCIAIO STEEL SPRING per / for PROFILO EUROPEO EUROPEAN PROFILE 07554-92
		GHIERA / CIRCLIP EURO / CLL CYLINDER 07558-05	GHIERA / CIRCLIP EURO / CLL CYLINDER 07558-05	GHIERA / CIRCLIP EURO / CLL CYLINDER 07558-05	GHIERA / CIRCLIP CYLINDER 07558-01	ASIX P8	

	PERNO INFERIORE LOWER PIN  07571-71	PERNO INFERIORE LOWER PIN  07571-72	PERNO INFERIORE LOWER PIN  07571-73	PERNO INFERIORE LOWER PIN  07571-74	PERNO INFERIORE LOWER PIN  07571-77	PERNO INFERIORE LOWER PIN  07571-78	
CONTROPERNO DRIVER  07572-96		CONTROPERNO DRIVER  07572-87	CONTROPERNO DRIVER  07572-88	CONTROPERNO DRIVER  07572-89	CONTROPERNO DRIVER  07572-63		PERNO SUPERIORE UPPER PIN  07571-79
CONTROPERNO DRIVER  07572-72	CONTROPERNO DRIVER  07572-77	CONTROPERNO DRIVER  07572-78					
	CONTROPERNO BKP BKP DRIVER  07572-91	CONTROPERNO BKP BKP DRIVER  07572-92	MOLLA BRONZO BRONZE SPRING  per / for CILINDRI SIGILLO SNAP RESISTANT 07554-71	MOLLA BRONZO BRONZE SPRING  per / for PROFILO EUROPEO EUROPEAN PROFILE 07554-72	MOLLA / SPRING  per / for CILINDRI VARI VARIOUS CYLINDER 07554-73	MOLLA ACCIAIO STEEL SPRING  per / for CILINDRI SIGILLO SNAP RESISTANT 07554-91	MOLLA ACCIAIO STEEL SPRING  per / for PROFILO EUROPEO EUROPEAN PROFILE 07554-92
		GHIERA / CIRCLIP EURO / CLL CYLINDER  07558-05	GHIERA / CIRCLIP EURO / CLL CYLINDER  07558-05	GHIERA / CIRCLIP EURO / CLL CYLINDER  07558-05	GHIERA / CIRCLIP RIM CYLINDER  07558-01	ASTRAL SIGILLO MEZZO VARI	

	PERNO INFERIORE LOWER PIN  07571-71	PERNO INFERIORE LOWER PIN  07571-72	PERNO INFERIORE LOWER PIN  07571-73	PERNO INFERIORE LOWER PIN  07571-74	PERNO INFERIORE LOWER PIN  07571-77	PERNO INFERIORE LOWER PIN  07571-78	
		CONTROPERNO DRIVER  07572-87					
CONTROPERNO DRIVER  07572-72	CONTROPERNO DRIVER  07572-77	CONTROPERNO DRIVER  07572-78					
				MOLLA BRONZO BRONZE SPRING  per / for PROFILO EUROPEO EUROPEAN PROFILE 07554-72	MOLLA / SPRING  per / for CILINDRI VARI VARIOUS CYLINDER 07554-73		
		GHIERA / CIRCLIP EURO / CLL CYLINDER  07558-05	GHIERA / CIRCLIP EURO / CLL CYLINDER  07558-05	GHIERA / CIRCLIP EURO / CLL CYLINDER  07558-05	GHIERA / CIRCLIP RIM CYLINDER  07558-01	ASIX	

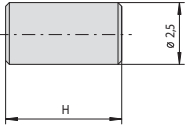
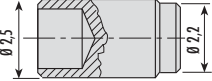
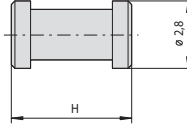
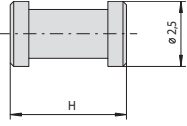
Type	Description	Bitting	H	Unit weight 	Pieces 	ITEM			
						Type	Dim.	Hand	Fin.
	<ul style="list-style-type: none"> Carbonitrided steel pin for cylinders and padlocks with key item 00401, 01310, 01320, 01330 root depth: 0.65 mm. 	1	5,20	0,305	1000	1	07551	01	0
		2	5,85	0,340	1000	1	07551	02	0
		3	6,50	0,370	1000	1	07551	03	0
		4	7,15	0,384	1000	1	07551	04	0
		5	7,80	0,430	1000	1	07551	05	0
		6	8,45	0,480	1000	1	07551	06	0
	<ul style="list-style-type: none"> Bronze pin for cylinders and padlocks with key item 00500 and 00450 root depth: 0.5 mm. 		4,00	0,235	1000	1	07551	11	0
		1	4,50	0,250	1000	1	07551	12	0
		2	5,00	0,250	1000	1	07551	13	0
		3	5,50	0,315	1000	1	07551	14	0
		4	6,00	0,330	1000	1	07551	15	0
		5	6,50	0,365	1000	1	07551	16	0
		6	7,00	0,400	1000	1	07551	17	0
7	7,50	0,480	1000	1	07551	18	0		
	<ul style="list-style-type: none"> Carbonitrided steel pins for C2000 cylinders with key item 01070 root depth: 0.44 mm. 	1	5,20	0,305	1000	1	07551	01	0
		2	5,64	0,285	1000	1	07551	41	0
		3	6,07	0,330	1000	1	07551	42	0
		4	6,50	0,370	1000	1	07551	03	0
		5	6,94	0,365	1000	1	07551	43	0
		6	7,37	0,400	1000	1	07551	44	0
		7	7,80	0,430	1000	1	07551	05	0
		8	8,25	0,460	1000	1	07551	45	0
	<ul style="list-style-type: none"> Bronze pin for padlocks with key item 01410, 01420, 01425, 01430 root depth: 0.65 mm. 	1	4,45	0,206	1000	1	07551	51	0
		2	5,10	0,250	1000	1	07551	52	0
		3	5,75	0,260	1000	1	07551	53	0
		4	6,40	0,300	1000	1	07551	54	0
		5	7,05	0,322	1000	1	07551	55	0
		6	7,70	0,350	1000	1	07551	56	0
	<ul style="list-style-type: none"> Brass driver for cylinders and padlocks with key item 00401, 00450, 00500, 01310, 01320, 01330, 01070 		3,00	0,295	1000	1	07552	01	0
			4,00	0,226	1000	1	07552	02	0
			5,00	0,305	1000	1	07552	03	0
	<ul style="list-style-type: none"> Brass driver for cylinders and padlocks with key item 01410, 01420, 01425, 01430 Brass driver for padlocks item 1.22010.30.0 		3,85	0,215	1000	1	07552	51	0
			3,4	0,215	1000	1	07552	04	0
	<ul style="list-style-type: none"> Mushroom brass driver for ASTRAL cylinders with key item 1.00620.01.0, 1.00620.90.0 	1	8,00	0,410	1000	1	07552	71	0
		2	7,50	0,410	1000	1	07552	72	0
		3	7,00	0,410	1000	1	07552	73	0
		4	6,50	0,410	1000	1	07552	74	0
		5	6,00	0,410	1000	1	07552	75	0

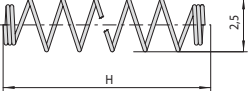







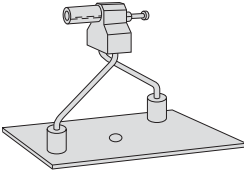

Type	Description	Bitting	H	Kg	Pieces	ITEM				
						Type	Dim.	Hand	Fin.	Pers.
	<ul style="list-style-type: none"> Brass driver for ASTRAL and ASIX cylinders with key item 1.00620.01.0, 1.00620.90.0, 1.00670.00.0 	6	5,50	0,410	1000	1	07552	76	0	
	<ul style="list-style-type: none"> Brass driver for ASTRAL and ASIX rim cylinders with key item 1.00620.01.0, 1.00620.90.0, 1.00670.01.0 	1	5,50	0,410	1000	1	07552	81	0	
		2	0,00	0,410	1000	1	07552	82	0	
		3	4,50	0,410	1000	1	07552	83	0	
		4	3,95	0,410	1000	1	07552	84	0	
		5	3,30	0,410	1000	1	07552	85	0	
		6	2,65	0,410	1000	1	07552	86	0	
	<ul style="list-style-type: none"> Mushroom brass driver for cylinders and padlocks with key item 00401, 00450, 00500, 01310, 01320, 01330, 01070 	3,00	0,255	1000	1	07553	01	0		
		4,00	0,212	1000	1	07553	02	0		
		5,00	0,228	1000	1	07553	03	0		
	<ul style="list-style-type: none"> Mushroom brass driver for cylinders and padlocks with key item 01410, 01420, 01425, 01430 	3,85	0,170	1000	1	07553	51	0		
	<ul style="list-style-type: none"> Mushroom brass driver for padlocks item 1.22010.30.0 	3,4	0,170	1000	1	07553	04	0		
	<ul style="list-style-type: none"> Brass spring for cylinders series 02500 and 06500 	13,50	0,095	1000	1	07554	01	0		
	<ul style="list-style-type: none"> Brass spring for cylinders series 02550, 02552, 06200 	10,50	0,080	1000	1	07554	02	0		
	<ul style="list-style-type: none"> Brass spring for: Cylinders series C2000, 08300, 08700, 08800 Padlocks item 1.22010.50/60 and 1.26010.50/60 	15,50	0,094	1000	1	07554	03	0		
	<ul style="list-style-type: none"> Brass spring for cylinders series 07573 	10,70	0,102	1000	1	07554	05	0		
	<ul style="list-style-type: none"> Brass spring for padlocks item 1.22010.30/40 	9,00	0,080	1000	1	07554	51	0		

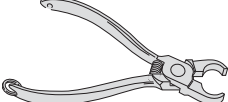
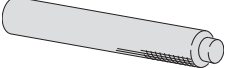
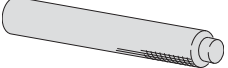
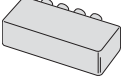

Type	Description	Bitting	H	Unit weight 	Pieces 	ITEM				
						Type	Dim.	Hand	Fin.	Pers. Spec.
	• Bronze spring for ASTRAL SIGILLO cylinders	9,50	0,078	1000	1	07554	71	0		
	• Bronze spring for ASTRAL, ASIX and ASIXP8 cylinders	12,00	0,065	1000	1	07554	72	0		
	• Bronze spring for ASTRAL, ASIX and ASIXP8 rim cylinders	10,00	0,102	1000	1	07554	73	0		
	• Steel spring for snap resistant cylinders SIGILLO	9,50	0,078	1000	1	07554	91	0		
	• Steel spring for mortice cylinders	12,00	0,065	1000	1	07554	92	0		
	• Brass master pin for cylinders and padlocks with key item 00401, 01310, 01320, 01330, 01070	1	0,55	0,070	1000	1	07555	01	0	
	• root depth: 0,65 mm.	2	1,20	0,100	1000	1	07555	02	0	
		3	1,85	0,145	1000	1	07555	03	0	
		4	2,50	0,177	1000	1	07555	04	0	
		5	3,15	0,213	1000	1	07555	05	0	
	• Brass additional master pin for cylinders and padlocks with key item 00401, 01310, 01320, 01330, 01070	1	0,65	0,078	1000	1	07555	11	0	
	• root depth: 0,65 mm.	2	1,30	0,100	1000	1	07555	12	0	
		3	1,95	0,145	1000	1	07555	13	0	
		4	2,65	0,175	1000	1	07555	14	0	
	• Brass master pin for cylinders and padlocks with key item 00450, 00500	2	1,00	0,095	1000	1	07555	21	0	
	• root depth: 0,5 mm.	3	1,50	0,120	1000	1	07555	22	0	
		4	2,00	0,130	1000	1	07555	23	0	
		5	2,50	0,185	1000	1	07555	24	0	
		6	3,00	0,170	1000	1	07555	25	0	
		7	3,50	0,230	1000	1	07555	26	0	
	• Additional brass master pin for complex systems with ASTRAL, ASIX, C3000, TEKNO and AP4 cylinders	2	0,96	0,078	1000	1	07555	31	0	
	• root depth 0,48 mm.	3	1,44	0,078	1000	1	07555	32	0	
		4	1,92	0,078	1000	1	07555	39	0	
		5	2,40	0,078	1000	1	07555	40	0	
	• Brass master pin for ASTRAL, ASIX, C3000, TEKNO and AP4 cylinders	2	0,88	0,213	1000	1	07555	33	0	
	• root depth: 0,48 mm.	3	1,36	0,213	1000	1	07555	34	0	
		4	1,84	0,213	1000	1	07555	35	0	
		5	2,32	0,213	1000	1	07555	36	0	
		6	2,80	0,213	1000	1	07555	37	0	
		7	3,28	0,213	1000	1	07555	38	0	
	• Brass master pin for cylinders and padlocks with key item 01410, 01420, 01425, 01430	1	0,55	0,067	1000	1	07555	51	0	
	• root depth: 0,65 mm.	2	1,20	0,095	1000	1	07555	52	0	
		3	1,85	0,125	1000	1	07555	53	0	
		4	2,50	0,153	1000	1	07555	54	0	
		5	3,15	0,170	1000	1	07555	55	0	
	• Additional brass master pin for complex systems with key item 01410, 01420, 01425, 01430	1	0,65	0,073	1000	1	07555	61	0	
	• root depth: 0,65 mm.	2	1,30	0,097	1000	1	07555	62	0	
		3	1,95	0,121	1000	1	07555	63	0	
		4	2,60	0,154	1000	1	07555	64	0	

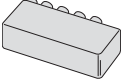
Type	Description	Bitting	H	Kg	Pieces	ITEM				
						Type	Dim.	Hand	Fin.	Pers. C.
	• Brass plug retaining pin for padlocks item 1.22010.30.0	11,6	0,165	250	1	07556	03	0		
	• Brass plug retaining pin for padlocks item 1.22010.40.0	16,8	0,270	250	1	07556	04	0		
	• Brass plug retaining pin for padlocks item 1.22010.50.0	21,2	0,313	250	1	07556	05	0		
	• Brass plug retaining pin for padlocks item 1.22010.60.0	26,1	0,360	250	1	07556	06	0		
	• Brass pin hole plug for padlocks item 1.22010.50.0	4,50	0,323	1000	1	07557	01	0		
	• Brass pin hole plug for padlocks item 1.22010.60.0	9,50	0,630	1000	1	07557	02	0		
	• Brass pin hole plug for cylinders series C2000, 08300, 08700, 08800	5,5	0,295	1000	1	07557	11	0		
	• Pin hole plug for padlocks item 1.22010.40.0	5,50	0,322	1000	1	07557	52	0		
	• Pin hole plug for padlocks item 1.22010.30.0	2,6	0,322	1000	1	07557	03	0		
	• Brass plug retaining circlip for rim cylinders	0,195		250	1	07558	01	0		
	• Brass circlip for rim cylinders	0,275		250	1	07558	02	0		
	• Brass plug retaining circlip for cylinders series 07573	0,275		250	1	07558	03	0		
	• Steel circlip for rim cylinders	0,275		250	1	07558	05	0		
	• Hardened steel pin for cylinders and padlocks with key item 00450 and 00500	4,00	0,400	1000	1	07571	11	0		
	1	4,50	0,400	1000	1	07571	12	0		
	2	5,00	0,400	1000	1	07571	13	0		
	3	5,50	0,295	1000	1	07571	14	0		
	4	6,00	0,400	1000	1	07571	15	0		
	5	6,50	0,400	1000	1	07571	16	0		
	6	7,00	0,400	1000	1	07571	17	0		
	7	7,50	0,400	1000	1	07571	18	0		

Type	Description	Bitting	H	Unit weight 	Pieces 	ITEM				
						Type	Dim.	Hand	Fin.	Pers.
	<ul style="list-style-type: none"> Hardened steel pin for ASTRAL, ASIX, ASIXP8, C3000 and AP4 cylinders with key item 1.00430.00.1, 1.00810.00.0, 1.00620.01.0, 1.00620.90.0 1.00670.01.0, root depth: 0,48 mm. 	0	4,57	0,155	1000	1	07571	70	0	
		1	5,05	0,155	1000	1	07571	71	0	
		2	5,53	0,155	1000	1	07571	72	0	
		3	6,01	0,155	1000	1	07571	73	0	
		4	6,49	0,155	1000	1	07571	74	0	
		5	6,97	0,155	1000	1	07571	75	0	
		6	7,45	0,155	1000	1	07571	76	0	
		7	7,93	0,155	1000	1	07571	80	0	
	<ul style="list-style-type: none"> Hardened steel driver for cylinders and padlocks with key item 00401, 00450, 00500, 01313, 01320, 01330 	2,50	0,235	1000	1	07572	01	0		
		3,50	0,235	1000	1	07572	02	0		
		5,00	0,272	1000	1	07572	03	0		
	<ul style="list-style-type: none"> Steel driver for rim and various cylinders from the ASTRAL, ASIX and ASIXP8 series 	1	5,50	0,380	1000	1	07572	71	0	
		2	5,00	0,380	1000	1	07572	72	0	
		3	4,50	0,380	1000	1	07572	73	0	
		4	3,95	0,380	1000	1	07572	74	0	
		5	3,30	0,380	1000	1	07572	75	0	
		6	2,65	0,380	1000	1	07572	76	0	
	<ul style="list-style-type: none"> Steel driver for mortice-single cylinders 	1	8,00	0,410	1000	1	07572	81	0	
		2	7,50	0,410	1000	1	07572	82	0	
		3	7,00	0,410	1000	1	07572	83	0	
		4	6,50	0,410	1000	1	07572	84	0	
	<ul style="list-style-type: none"> Steel driver 	5-6	5,50	0,380	1000	1	07572	87	0	
	<ul style="list-style-type: none"> Hardened steel driver for key notch detection for SIGILLO cylinders 	1	7,00	0,410	1000	1	07572	83	0	
		2	6,50	0,410	1000	1	07572	84	0	
		3	6,00	0,410	1000	1	07572	85	0	
		4	5,50	0,410	1000	1	07572	88	0	
	<ul style="list-style-type: none"> Steel driver for snap resistant cylinders 	5-6	4,50	0,410	1000	1	07572	89	0	
	<ul style="list-style-type: none"> Hardened steel upper passive pin 	5,80	0,241	1000	1	07571	79	0		
	<ul style="list-style-type: none"> BKP steel driver assembly CISA patented system 	8,00	0,155	1000	1	07572	90	0		
		1	7,00	0,155	1000	1	07572	91	0	
		2-3	6,50	0,155	1000	1	07572	92	0	

Type	Description	Bitting	H	Unit weight 	Pieces 	ITEM			
						Type	Dim.	Hand	Fin.
	<ul style="list-style-type: none"> Hardened steel pin for ASTRAL TEKNO, ASIXP8 cylinders Root depth: 0.48 mm. 	1	5,05	0,155	1000	1	07571	71	0
		2	5,53	0,155	1000	1	07571	72	0
		3	6,01	0,155	1000	1	07571	73	0
		4	6,49	0,155	1000	1	07571	74	0
		5	6,97	0,155	1000	1	07571	77	0
		6	7,45	0,155	1000	1	07571	78	0
	<ul style="list-style-type: none"> Hardened steel driver for European profile ASTRAL TEKNO cylinders 	4	6,50	0,410	1000	1	07572	96	0
	<ul style="list-style-type: none"> Hardened steel pin driver for European profile ASTRAL TEKNO cylinders 	5/6	5,50	0,410	1000	1	07572	87	0
	<ul style="list-style-type: none"> Hardened steel pin driver for cylinders notch position detection for European profile ASTRAL TEKNO cylinders 	-	5,50	0,410	1000	1	07572	88	0
	<ul style="list-style-type: none"> Steel driver for rim and various from ASTRAL TEKNO, ASIXP8 cylinders 	1	5,50	0,380	1000	1	07572	71	0
		2	5,00	0,380	1000	1	07572	72	0
		3	4,50	0,380	1000	1	07572	73	0
		4	4,00	0,380	1000	1	07572	77	0
		5/6	3,30	0,380	1000	1	07572	78	0
	<ul style="list-style-type: none"> Hardened steel pin driver for cylinders notch position detection for rim and various ASTRAL TEKNO cylinders 	-	3,3	0,380	1000	1	07572	75	0
	<ul style="list-style-type: none"> Hardened steel pin for key notch detection for ASTRAL TEKNO cylinders 	-	5,30	0,241	1000	1	07571	93	0
	<ul style="list-style-type: none"> Hardened steel pin for key back detection for ASTRAL TEKNO cylinders 	-	4,70	0,241	1000	1	07571	94	0

Type	Description	For series/item	Unit weight Kg	Pieces	ITEM				
					Type	Dim.	Hand	Fin.	Pers. Spec.
	<ul style="list-style-type: none"> • Dummy plug • Holes spacing: 4 mm. 	0G300, 02500,08310, 08710	0,660	1	1	07559	01	0	
	<ul style="list-style-type: none"> • Spring retaining shoe 	0G300, 08310, 08710	0,030	1	1	07559	02	0	
	<ul style="list-style-type: none"> • Spring pressing blade 	0A300, 0E300, 0M300, 10Q311	0,015	1	1	07559	62	0	
	<ul style="list-style-type: none"> • Spring pressing blade 	0A300, 0E300, 0M300, 0Q311	0,018	1	1	07559	63	0	
	<ul style="list-style-type: none"> • Circlip pliers • Circlip pliers Astral Tekno cylinders 		0,190	1	1	07559	04	0	
	<ul style="list-style-type: none"> • Spring retaining bar for rim cylinders 		0,190	1	1	07559	42	0	
	<ul style="list-style-type: none"> • Spring retaining bar for rim cylinders 		0,105	1	1	07559	06	0	
	<ul style="list-style-type: none"> • Testing tool 	1 22010 50 0	0,025	1	1	07559	07	0	
	<ul style="list-style-type: none"> • Set of depth keys item 01310 (6 pieces) 		0,061	1	1	07559	09	0	
	<ul style="list-style-type: none"> • Testing tool 	1 22010 40 0	0,025	1	1	07559	11	0	
	<ul style="list-style-type: none"> • Set of depth keys item 01410 (6 pieces) 		0,046	1	1	07559	12	0	
	<ul style="list-style-type: none"> • Pin gauge (increment 0.65 mm.) 	01310, 01410	0,035	1	1	07559	13	0	
	<ul style="list-style-type: none"> • Pin gauge (increment 0,44 mm.) 	01070	0,035	1	1	07559	48	0	

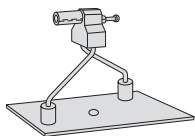
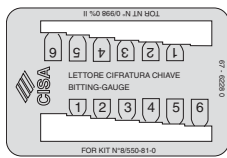
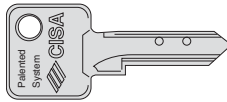
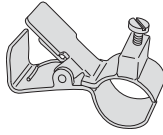
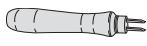
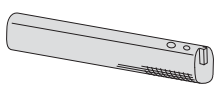
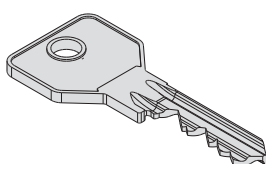
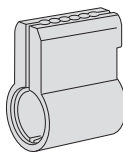
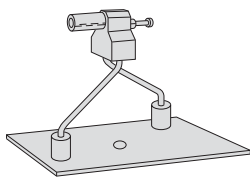
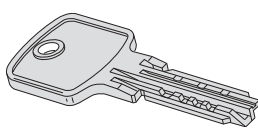
Type	Description	For series/item	 Unit weight  Pieces	ITEM			
				Type	Dim.	Hand	Fin.
	<ul style="list-style-type: none"> • Dummy plug • Holes spacing: 3.5 mm. 	08810, 08815	0,660	1	1	07559 19 0	
	<ul style="list-style-type: none"> • Pin gauge (increment 0.5 mm.) 	08810, 08815	0,015	1	1	07559 22 0	
	<ul style="list-style-type: none"> • Set of depth keys item 00450 (8 pieces) 	08810, 08815	0,150	1	1	07559 23 0	
	<ul style="list-style-type: none"> • Butterfly-type spring retaining shoe for cylinders with knob 		0,050	1	1	07559 24 0	
	<ul style="list-style-type: none"> • Ball assembling tool for cylinders with knob 		0,050	1	1	07559 25 0	
	<ul style="list-style-type: none"> • Knob assembling tool for cylinders with knob 		0,050	1	1	07559 26 0	
	<ul style="list-style-type: none"> • Set of depth keys item 01070 (8 pieces) 	0G300	0,081	1	1	07559 28 0	
	<ul style="list-style-type: none"> • Spring positioning tool 	0A300, 0E300, 0M300, 0Q311 0N300	0,055	1	1	07559 80 0	
	<ul style="list-style-type: none"> • Dummy plug 	0A300, 0E300, 0M300, 0Q311 0N300	2,750	1	1	07559 81 0	
	<ul style="list-style-type: none"> • Set of depth keys Astral item 00620 	0A300	0,061	1	1	07559 83 0	

Type	Description	For series/item	Kg	Pcs	ITEM				
					Type	Dim.	Hand	Fin.	Pers.

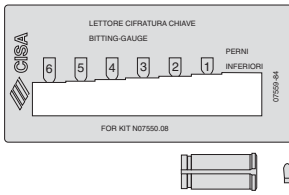

• Key bitting check kit, for Astral cylinder keys

0A300

0,015

1

1 07559 84 0

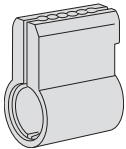

• Spring positioning tool

0G300,
08310, 08710

0,080

1

1 07559 85 0

Type	Description	For series/item	Unit weight Pieces	ITEM				
				Type	Dim.	Hand	Fin.	Pers. Spec.
	<ul style="list-style-type: none"> • Set of steel levers • 3 keys item 1.00102.00.1 	57010, 57014, 57015, 57019, 57028, 57033	0,180	6	1	07590	01	0
	<ul style="list-style-type: none"> • Set of steel levers • 3 keys item 1.00102.00.1 	57020, 57024	0,255	6	1	07590	05	0
	<ul style="list-style-type: none"> • Set of steel levers • 3 keys item 1.00102.00.1 	57210, 57211, 57215, 57217, 57800	0,120	6	1	07590	12	0
	<ul style="list-style-type: none"> • Set of steel levers • 3 keys item 1.00102.00.1 	1 57410 30 1, 1 57415 30 1, 57220, 57223, 57225, 57226	0,120	6	1	07590	15	0
	<ul style="list-style-type: none"> • Set of steel levers • 3 keys item 1.00102.00.1 	57230	0,170	6	1	07590	18	0
	<ul style="list-style-type: none"> • Set of steel levers • 3 keys item 1.00102.00.1 	57250, 57251, 57254, 57255, 57256, 57259, 57260, 57265	0,160	6	1	07590	21	0

Type	Description	For series/item	Unit weight 	Pieces 	ITEM			
					Type	Dim.	Hand	Fin.
	<ul style="list-style-type: none"> • Set of steel levers • 3 keys item 1.00100.00.1 	17352, 17353, 17357, 17358, 57013, 57016, 57030, 57035, 57312, 57313, 57317, 57318, 57320, 57325, 57330, 57333, 57335, 57336, 57352, 57353, 57357, 57358, 57360, 57365, 57370, 57375	0,142	6	1	07590	23	0
	<ul style="list-style-type: none"> • Set of steel levers • 3 keys item 1.00121.00.2 	57121	0,170	6	1	07590	24	0
	<ul style="list-style-type: none"> • Set of steel levers • 3 keys item 1.00120.00.1 	1 57115 60 1, 1 57125 60 1, 1 57135 60 1, 57500, 57502, 57505, 57507, 57510, 57512, 57515, 57517, 57520, 57525, 57530, 57535	0,185	6	1	07590	25	0
	<ul style="list-style-type: none"> • Set of steel levers • 3 keys item 1.00120.00.1 	1 57110 60 1, 1 57120 60 1, 1 57130 60 1	0,185	6	1	07590	26	0
	<ul style="list-style-type: none"> • Set of steel levers • 3 keys item 1.00120.00.2 	1 57110 60 2, 1 57120 60 2, 1 57130 60 2	0,195	6	1	07590	27	0
	<ul style="list-style-type: none"> • Set of steel levers • 3 keys item 1.00120.00.2 	1 57115 60 2, 1 57125 60 2, 1 57135 60 2	0,170	6	1	07590	28	0

Type	Description	For series/item	Unit weight Pieces	ITEM				
				Type	Dim.	Hand	Fin.	Peris. Spec.
	<ul style="list-style-type: none"> • Set of steel levers • 3 keys item 1.00123.00.1 • 1 service key item 1.00120.00.1 	57501,57506, 57511,57516, 57518,57521, 57526, 57536	0,213	6	1	07590	29 0	
	<ul style="list-style-type: none"> • Set of steel levers • 3 keys item 1.00123.00.1 • 1 construction key item 1.00120.00.1 	57501,57506, 57511,57516, 57518,57520, 57521,57526, 57536	0,210	6	1	07590	30 0	
	<ul style="list-style-type: none"> • Set of steel levers • 3 keys item 1.00125.00.1 	1 57155 60 1, 1 57165 60 1, 1 57175 60 1, 1 57500 08 0, 1 57505 08 0, 1 57510 08 0, 1 57515 08 0	0,210	6	1	07590	35 0	
	<ul style="list-style-type: none"> • Set of steel levers • 3 keys item 1.00125.00.1 	1 57150 60 1, 1 57160 60 1, 1 57170 60 1	0,200	6	1	07590	36 0	
	<ul style="list-style-type: none"> • Set of steel levers • 3 keys item 1.00125.00.2 	1 57150 60 2, 1 57160 60 2, 1 57170 60 2	0,233	6	1	07590	37 0	
	<ul style="list-style-type: none"> • Set of steel levers • 3 keys item 1.00125.00.2 	1 57155 60 2, 1 57165 60 2, 1 57175 60 2	0,212	6	1	07590	38 0	

Type	Description	For series/item	Unit weight Pieces	ITEM				
				Type	Dim.	Hand	Fin.	Pers. Spec.
	<ul style="list-style-type: none"> • Set of steel levers • 2 keys item 1.00101.00.2 	1 57409 30 1, 1 57411 30 1, 1 57416 30 1	0,100	6	1	07590	45	0
	<ul style="list-style-type: none"> • Set of steel levers • 3 keys item 1.00100.00.1 	57010, 57015	0,152	6	1	07591	01	0
	<ul style="list-style-type: none"> • Set of steel levers • 3 keys item 1.00100.00.1 	57020	0,246	6	1	07591	05	0
	<ul style="list-style-type: none"> • Set of steel levers • 3 keys item 1.00100.00.1 	57210, 57211, 57215, 57800 57218, 57298	0,100	6	1	07591	12	0
	<ul style="list-style-type: none"> • Set of steel levers • 3 keys item 1.00100.00.1 	1 57410 30 1, 1 57415 30 1, 57219, 57220, 57223, 57225, 57226, 57299	0,100	6	1	07591	15	0
	<ul style="list-style-type: none"> • Set of steel levers • 3 keys item 1.00100.00.1 	57250, 57255, 57260, 57265	0,154	6	1	07591	21	0

Type	Description	For series/item	 Unit weight	 Pieces	ITEM			
					Type	Dim.	Hand	Fin.

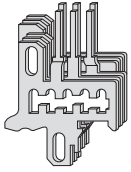

- Set of steel levers
- 3 keys item 1.00122.00.1

57500, 57505,
57510, 57515,
57517, 57520,
57525, 57535

0,202

6

1 07591 29 0

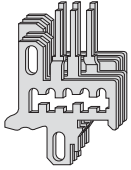
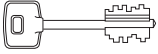

- Set of steel levers
- 3 keys item 1.00122.00.1
- 1 service key item 1.00121.00.1

57501, 57506,
57511, 57516,
57518, 57521,
57526, 57536

0,100

6

1 07591 39 0

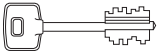

N. B.:

- The products listed have all the characteristics indicated in the technical descriptions of CISA's catalogue, and it is advised to use them only as indicated. CISA does not guarantee any characteristics or use other than indicated.
For special security needs the end-user should contact the retailer / installer of such products, or contact CISA directly to agree on specific variations to best meet the user's needs.
- The measurements are given in millimetres.
- Weights refer to unit item, not to the package.
- To download the product certifications click on www.cisa.com

CISA S.p.A. reserves the right to modify products here illustrated without prior notice.

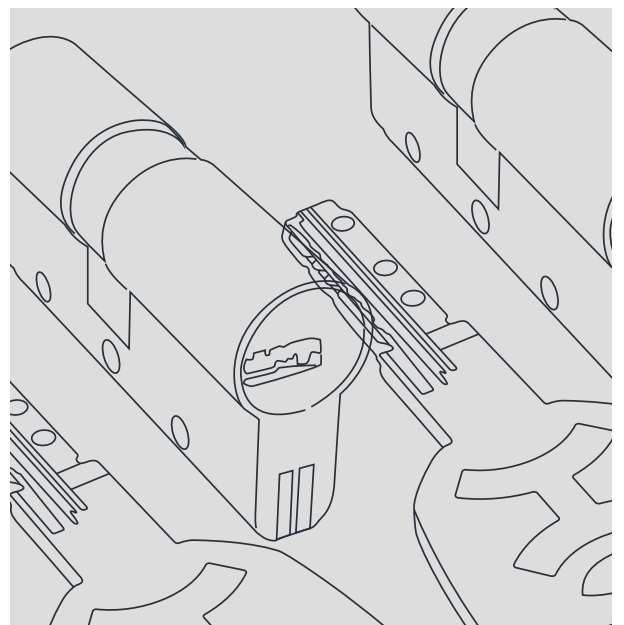



About Allegion

Allegion (NYSE: ALLE) is a global pioneer in seamless access, with leading brands like CISA®, Interflex®, LCN®, Schlage®, SimonsVoss® and Von Duprin®. Focusing on security around the door and adjacent areas, Allegion secures people and assets with a range of solutions for homes, businesses, schools and institutions.





For more, visit allegion.com.



 CISA SpA
Via Oberdan 42
48018 Faenza (RA) Italy

 Ph. +39 0546 677111
Fax +39 0546 677150

 Customer Service and Technical Support
+39 0546 188 0070

    cisa.com
cisa.sales@allegion.com